

NORTHCLIFFE

making life brighter



CATALOGUE 2024

By Secondway in Belgium

NORTHCLIFFE

making life brighter



NORTHCLIFFE LIGHTING is a customer oriented, innovative solutions-driven company, which manufactures commercial and industrial lighting fixtures, provides lighting design, technical consulting and OEM services to customers all over the world. Established in 1993 with the business units in the UK, Lithuania and Ukraine, and achieving constant development over the last 30 years, Northcliffe Lighting has become one of the best-known independent lighting fixtures manufacturers in Central and Eastern Europe. Due to the constant expansion of distribution network our product range, exceeding 4000 kinds of lighting fixtures and various energy saving options can be found in more than 40 countries all over the world. User friendly, innovative, reliable and affordable lighting solutions together with dedicated customer service are **MAKING LIFE BRIGHTER**.



A wide knowledge in lighting combined with a wide range of latest technology, energy-efficient and environmentally friendly solutions makes us the reliable partner for any project. Our strong technical support is always ready to assist with the selection of the most suitable products, preparation of designs, calculations, visualisations and even creation of customised products. We are strongly committed to invest in technology, training and R&D activities to develop better products, services and more efficient lighting solutions.

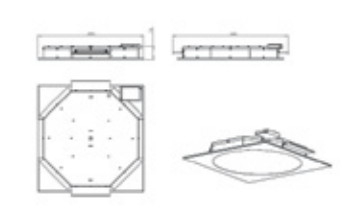
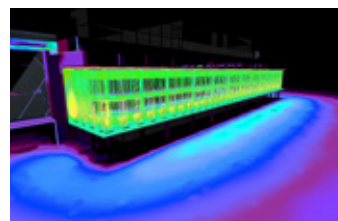
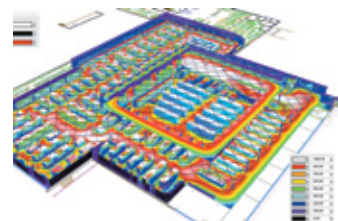
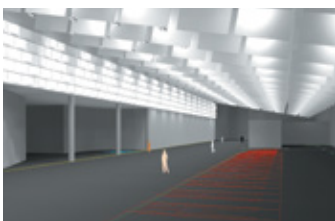

Quality is the main value, all of our products are made using high quality components from reputable European suppliers. We use the most advanced technologies, some of which are unique and patented, to produce efficient products for easy installation, effective storage and transportation.



Compliance of various norms and standards is crucial when working with different markets. All of our products are individually tested before leaving our factories and comply with provisions of EU Directives, harmonized standards, UK Conformity Assessment, RoHS and UkrSEPRO requirements.



NORTHCLIFFE LIGHTING is constantly looking for the ways how to enhance good business practices, improve customer service and product quality. An implemented integrated management system with the set of quality management (**ISO 9001**), environmental management (**ISO 14001**) and occupational health and safety management (**ISO 45001**) tools allow us to develop and implement a policy and objectives that take into account the satisfaction of the interested parties, compliance with environmental legal requirements and control of the risks to safety and health at work, through the determination of the necessary processes to effectively achieve the commitments of the policy and take the necessary actions to improve our performance.



This catalogue present our most popular products to make it easier for our potential partners to make the best choices. We believe that it will help you to identify the best solutions and make **NORTHCLIFFE LIGHTING** your reliable business partner to start **MAKING LIFE BRIGHTER** together!









For further and most up-to-date information please visit www.northcliffe.org or send us an email to info@northcliffe.org

Contents

How to use this catalog?	12
INTRODUCTION	15
Independent PIR sensors	25
MW sensors	43
KR wireless system	51
EAIR wireless system	57
BLT wireless system	65
LED street lighting controls	71
PRODUCT RANGE	
Recessed luminaires	79
Surface and suspended luminaires	125
Aluminium profile luminaires	167
Freestanding luminaires	217
Acoustic luminaires	221
Continuous line and batten luminaires	243
Diffuser and wall luminaires	271
Waterproof and cleanroom luminaires	293
Explosion-proof luminaires	327
Anti-vandal luminaires	331
Emergency lighting	339
EMS MINI – emergency monitoring system	340
EMS – emergency monitoring system	342
CEBLV – central battery low voltage system	344
Spotlights	379
Track system and parts	415
Downlights	429
High-bays	457
Floodlight	477
Outdoor accent lighting	485
Park and street luminaires	523
LED strips and profiles	551
INFORMATION ABOUT LIGHTING	581
DESCRIPTION OF OPTIONS	587
CONTACTS	596

PRODUCT RANGE



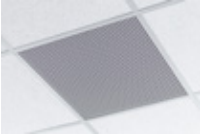















Recessed Luminaires

Eridanus R LED  IP40 • low glare 80	Eridanus I LED  IP40 • cut-out 83	Eridanus G LED  IP20 • low glare 85	Calima R LED  IP44 • low glare 87	Wing R LED  IP40 • low glare 90	Wing D LED  IP40 • soft-light 92
Jetta R LED  IP20 • soft-light 94	Corona C LED  IP40 • low glare 96	Corona Q LED  IP44 • low glare 98	Line U LED  IP40 • low glare 100	Line R LED  IP40 • low glare 102	CORNER90  IP40 • low glare 104
Rana LED  IP40 • low glare 106	Lyra R LED  IP20 108	Bali C LED  IP20 • frameless 109	Bali R LED  IP20 • frameless 110	Levanto UGR LED  IP40-44 • low glare 112	Levanto PLN LED  IP40-44 • opal 115
Levanto LED  IP40-44 • low glare 118	Metal grid tile  decorative 120	Space Q LED  IP40 • opal 121	Ceiling tile  acoustic 122	Barber R LED  IP40 • asymmetric 123	



Surface and Suspended Luminaires

Etesian S LED  IP40 • low glare 126	Etesian U LED  IP40 • low glare 128	Etesian U LED  IP40 • LG3 128	Calima S LED  IP44 • low glare 132	Calima U LED  IP40 • low glare 135	Calima U LED  IP40 • LG3 135
Bali S LED  IP40 • low glare 140	Bali U LED  IP40 • low glare 142	Bali U LED  IP40 • LG3 142	Lodos S LED  IP40 • low glare 146	Lodos L LED  IP40 • low profile 150	Lodos H LED  IP40 • ultra low 152
Bootes C LED  IP20 • direct/indirect 154	Bootes Q LED  IP20 • direct/indirect 157	Barber S LED  IP40 • asymmetric 159	Forma O LED  IP40 • decorative 160	Forma C LED  IP40 • decorative 162	Azure LED  IP40 • low glare 164

Aluminum profile Luminaires

<p>Serpens S LED</p>  <p>IP40 ▪ slim 168</p>	<p>Serpens LED</p>  <p>IP40-44 ▪ opal 172</p>	<p>CORNER90</p>  <p>176</p>	<p>Serpens P LED</p>  <p>IP40 ▪ reflector 178</p>	<p>Serpens O LED</p>  <p>IP40 ▪ optics 180</p>	<p>Decor S LED</p>  <p>IP40 ▪ slim 182</p>
<p>Decor LED</p>  <p>IP40-44 ▪ opal 184</p>	<p>CORNER90</p>  <p>188</p>	<p>Decor P LED</p>  <p>IP40 ▪ reflector 190</p>	<p>Decor O LED</p>  <p>IP40 ▪ optics 193</p>	<p>Decor L LED</p>  <p>IP40 ▪ LG3 196</p>	<p>CORNER90</p>  <p>198</p>
<p>Decor LP LED</p>  <p>reflector ▪ LG3 200</p>	<p>Decor LO LED</p>  <p>optics ▪ LG3 202</p>	<p>Quadro LED</p>  <p>IP40 ▪ decorative 204</p>	<p>Cross X LED</p>  <p>IP40 ▪ decorative 206</p>	<p>Triangle LED</p>  <p>IP40 ▪ decorative 208</p>	<p>Trio Y LED</p>  <p>IP40 ▪ decorative 210</p>
<p>Cross V LED</p>  <p>IP40 ▪ decorative 214</p>					

Freestanding Luminaires

<p>Fornax F LED</p>  <p>IP20 ▪ floor 218</p>	<p>Fornax T LED</p>  <p>IP20 ▪ desk 218</p>	<p>Rod LED</p>  <p>IP20 ▪ decorative 219</p>
--	---	--

Acoustic Luminaires

<p>Haud LED</p>  <p>IP40 ▪ acoustic 222</p>	<p>Forma A LED</p>  <p>IP40 ▪ acoustic 224</p>	<p>Forma G LED</p>  <p>IP40 ▪ moss 227</p>	<p>Quadro A LED</p>  <p>IP40 ▪ acoustic 230</p>	<p>Quadro G LED</p>  <p>IP40 ▪ moss 233</p>	<p>Moon A LED</p>  <p>IP40 ▪ acoustic 236</p>
<p>Block A LED</p>  <p>IP40 ▪ acoustic 237</p>	<p>Colour list</p>  <p>Felt 238</p>	<p>Cloud LED</p>  <p>IP40 ▪ fabric 239</p>	<p>Cloud LED</p>  <p>IP40 ▪ fabric 239</p>	<p>Cloud LED</p>  <p>IP40 ▪ fabric 239</p>	<p>Colour list</p>  <p>Fabric 241</p>

Continuous line and Batten Luminaires

<p>Blade W LED</p>  <p>IP23 • optics 244</p>	<p>Blade Z LED</p>  <p>IP23 • optics 246</p>	<p>Shop A LED</p>  <p>IP20 • in-line 248</p>	<p>CORNER90</p>  <p>251</p>	<p>CORNER180</p>  <p>253</p>	<p>CORNER360</p>  <p>256</p>
<p>Mall LED</p>  <p>IP20 • in-line 258</p>	<p>Bora Z LED</p>  <p>IP23 • with arm 262</p>	<p>Atria LED</p>  <p>IP40 • asymmetric 264</p>	<p>Shop B LED</p>  <p>IP20 • asymmetric 266</p>	<p>Zodiaq LED</p>  <p>IP23 • high output 268</p>	

Diffuser and Wall Luminaires

<p>Pupis P LED</p>  <p>IP65 • IK08 272</p>	<p>Cetus P LED</p>  <p>IP65 • IK08 273</p>	<p>Pavo P LED</p>  <p>IP44 • 4 sizes 274</p>	<p>Indus P LED</p>  <p>IP65 • IK08 276</p>	<p>Indus P LED</p>  <p>LOUVER 276</p>	<p>Heze P LED</p>  <p>IP65 • IK08 278</p>
<p>Heze P LED</p>  <p>LOUVER 278</p>	<p>Storm P LED</p>  <p>IP65 • IK08 280</p>	<p>Pollux P LED</p>  <p>IP54 • IK10 281</p>	<p>Dorado P LED</p>  <p>IP54 • IK10 282</p>	<p>Carina P LED</p>  <p>IP54 • IK05 283</p>	<p>Carina LED</p>  <p>IP44 • opal 286</p>
<p>Doctor P LED</p>  <p>IP54 • IK08 288</p>	<p>Mira LED</p>  <p>IP44 • with switch 289</p>	<p>Mira LED</p>  <p>with socket 289</p>	<p>Lupi LED</p>  <p>IP44 • up&down 290</p>		

Waterproof and Cleanroom Luminaires

<p>Barat LED</p>  <p>IP66 • IK10 294</p>	<p>Nord LED</p>  <p>IP66 • -40...+50°C 297</p>	<p>Proof LED</p>  <p>IP66 • aggressive 299</p>	<p>Cyclone P LED</p>  <p>IP69 • IK10 301</p>	<p>Cyclone A LED</p>  <p>IP69 • aggressive 303</p>	<p>Sumatra O LED</p>  <p>IP66 • optics 305</p>
<p>Sumatra LED</p>  <p>IP66 • IK10 308</p>	<p>Sumatra C LED</p>  <p>IP66 • direct/indirect 310</p>	<p>Cujam LED</p>  <p>IP65 • basic 312</p>	<p>Barat</p>  <p>IP66 • for LED tubes 313</p>	<p>Hercules LED</p>  <p>IP66 • aggressive 314</p>	<p>Inox LED</p>  <p>IP65 • aggressive 316</p>
<p>Hermetic R LED</p>  <p>IP65 • opal 318</p>	<p>Hermetic C LED</p>  <p>IP65 • clean room 320</p>	<p>Hermetic S LED</p>  <p>IP65 • opal 322</p>	<p>Navi P LED</p>  <p>IP54 • basic 324</p>		

Explosion-proof Luminaires

Barat LED Ex



IP66 • Ex 328

Anti-vandal Luminaires

<p>Caelum R LED</p>  <p>IP65 • IK10+ 332</p>	<p>Caelum S LED</p>  <p>IP65 • IK10+ 334</p>	<p>Caelum A LED</p>  <p>IP65 • IK10+ 336</p>	<p>BLANK</p>  <p>accessories 337</p>	<p>Caelum W LED</p>  <p>IP65 • IK10+ 338</p>
--	--	--	---	--

Emergency Lighting

<p>Nova SP LED</p>  <p>IP20 • optics 348</p>	<p>Ara R LED</p>  <p>IP65 • optics 349</p>	<p>Ara S LED</p>  <p>IP65 • optics 351</p>	<p>Ara S LED</p>  <p>IP65 • track 351</p>	<p>Corridor R LED</p>  <p>IP20 • optics 353</p>	<p>Corridor S LED</p>  <p>IP41 • optics 355</p>
<p>Knik LED</p>  <p>IP66 • high output 357</p>	<p>Norther LED</p>  <p>IP66 • outdoor 358</p>	<p>Scorpius M LED</p>  <p>IP65 • transparent 360</p>	<p>Taurus LED</p>  <p>IP41 • aluminium 361</p>	<p>Capella LED</p>  <p>IP20 • recessed 362</p>	<p>Helm LED</p>  <p>IP65 • transparent 363</p>
<p>Zonda LED</p>  <p>IP44 • 2x optics 365</p>	<p>Nashi S LED</p>  <p>IP44 • surface 366</p>	<p>Nashi S LED</p>  <p>IP44 • track 366</p>	<p>Nashi R LED</p>  <p>IP44 • recessed 368</p>	<p>Lepus S LED</p>  <p>IP40 • wall 369</p>	<p>Lepus W LED</p>  <p>IP40 • side 370</p>
<p>Leporis C LED</p>  <p>IP40 • ceiling 371</p>	<p>Leporis U LED</p>  <p>IP40 • suspended 372</p>	<p>Season LED</p>  <p>IP41 • four-sided 373</p>	<p>Libra LED</p>  <p>IP65 • test button 375</p>	<p>Gemini LED</p>  <p>IP65 • test button 376</p>	<p>Hydra LED</p>  <p>IP65 • test button 377</p>

Spotlights

<p>Pegasus H LED</p>  <p>IP20 • adjustable 380</p>	<p>Cursa LED</p>  <p>IP20 • adjustable 382</p>	<p>Heka LED</p>  <p>IP20 • narrow trim 384</p>	<p>Capheus B LED</p>  <p>IP20 • adjustable 386</p>	<p>Capheus S LED</p>  <p>IP20 • surface 388</p>	<p>Zoom A LED</p>  <p>IP20 • 20-60° 390</p>
--	--	--	---	---	---

Spotlights

<p>Santa LED</p>  <p>IP20 ▪ adjustable 392</p>	<p>Santa E LED</p>  <p>IP20 ▪ basic 393</p>	<p>Sharqi A LED</p>  <p>IP20 ▪ adjustable 394</p>	<p>Kali LED</p>  <p>IP20 ▪ adjustable 396</p>	<p>Delphinus LED</p>  <p>IP40 ▪ adjustable 398</p>	<p>Aquarius A LED</p>  <p>IP40 ▪ adjustable 400</p>
<p>Antlia T LED</p>  <p>IP20 ▪ opal 402</p>	<p>Spica LED</p>  <p>IP20 ▪ optics 404</p>	<p>Spica T LED</p>  <p>IP20 ▪ optics 406</p>	<p>Spica I LED</p>  <p>IP20 ▪ optics 408</p>	<p>Villy I LED</p>  <p>IP20 ▪ slim 410</p>	<p>Chara LED</p>  <p>IP20 ▪ suspended 412</p>

Track system and Parts

<p>ONETRACK®</p>  <p>white, black, light grey 416</p>	<p>Joints</p>  <p>418</p>	<p>Covers</p>  <p>419</p>	<p>GLOBAL Trac Pro®</p>  <p>white, black, grey 423</p>
---	---	---	---

Downlights

<p>Ain LED</p>  <p>IP44 ▪ adjustable 430</p>	<p>Ain A LED</p>  <p>IP65 ▪ fire rated 431</p>	<p>Ain B LED</p>  <p>IP44 ▪ adjustable 432</p>	<p>Ain C LED</p>  <p>IP65 ▪ fire rated 433</p>	<p>Ain D LED</p>  <p>IP44 ▪ adjustable 434</p>	<p>Coxa Q LED</p>  <p>IP20 ▪ low glare 435</p>
<p>Alva LED</p>  <p>IP44 ▪ low glare 436</p>	<p>Auriga LED</p>  <p>IP44 ▪ low glare 437</p>	<p>Auriga C LED</p>  <p>IP44 ▪ low glare 439</p>	<p>Crux LED</p>  <p>IP44 ▪ opal 441</p>	<p>Auriga P LED</p>  <p>IP44 ▪ low glare 442</p>	<p>Auriga P LED</p>  <p>square 442</p>
<p>Auriga P LED</p>  <p>drop glass 442</p>	<p>Crux P LED</p>  <p>IP44 ▪ opal 444</p>	<p>Andromeda P LED</p>  <p>IP44 ▪ basic 445</p>	<p>Round P LED</p>  <p>IP44 ▪ basic 446</p>	<p>Tetra A LED</p>  <p>IP44 ▪ MPRZ 448</p>	<p>Tetra R LED</p>  <p>IP40 ▪ recessed 450</p>
<p>Tetra S LED</p>  <p>IP40 ▪ surface 451</p>	<p>Antlia LED</p>  <p>IP20 ▪ low glare 452</p>	<p>Antlia C LED</p>  <p>IP44 ▪ opal 453</p>	<p>Perseus C LED</p>  <p>IP65 ▪ low glare 455</p>		

Highbays

<p>Prizma A LED</p>  <p>IP20 • decorative 458</p>	<p>Norte I LED</p>  <p>IP65 • IK08 460</p>	<p>Norte I LED SPORT</p>  <p>IP65 • IK10 460</p>	<p>Norte C LED</p>  <p>IP65 • -35°C 464</p>	<p>Norte L LED</p>  <p>IP65 • IK08 466</p>	<p>Brubu N LED</p>  <p>IP65 • IK08 468</p>
<p>BOX</p>  <p>accessory 469</p>	<p>Brubu E LED</p>  <p>IP65 • IK08 470</p>	<p>Disc LED</p>  <p>IP65 • basic 472</p>	<p>Disc A LED</p>  <p>IP65 • high efficiency 474</p>		

Floodlights

<p>Boreas M LED</p>  <p>IP65 • IK08 • optics 478</p>	<p>Beta LED</p>  <p>IP65 • basic 480</p>	<p>Taku LED</p>  <p>IP66 • IK08 481</p>	<p>Taku LED 2x</p>  <p>IP66 • IK08 481</p>	<p>Taku LED 3x</p>  <p>IP66 • IK08 481</p>
--	--	---	--	--

Outdoor Accent Luminaires

<p>Grus LED</p>  <p>IP65 • IK08 486</p>	<p>Grus LED</p>  <p>IP65 • IK08 486</p>	<p>Cygni LED</p>  <p>IP66 • IK09 488</p>	<p>Bull S LED</p>  <p>IP66 • IK08 490</p>	<p>Bull M LED</p>  <p>IP66 • IK08 492</p>	<p>Comet S LED</p>  <p>IP66 • IK08 494</p>
<p>Austr D LED</p>  <p>IP54 • up&down 496</p>	<p>Ray LED</p>  <p>IP65 • up&down 497</p>	<p>Tube M LED</p>  <p>IP65 • up&down 498</p>	<p>Tube M LED</p>  <p>IP65 • UP 498</p>	<p>Tube M LED</p>  <p>IP65 • ceiling 498</p>	<p>Tube S LED</p>  <p>IP54 • GU10 500</p>
<p>Pipe LED</p>  <p>IP65 • up&down 501</p>	<p>Pipe LED</p>  <p>IP65 • UP 501</p>	<p>Pipe LED</p>  <p>IP65 • ceiling 501</p>	<p>Cube LED</p>  <p>IP65 • up&down 503</p>	<p>Cube UP LED</p>  <p>IP65 • UP 503</p>	<p>Cube SR LED</p>  <p>IP65 • ceiling 503</p>
<p>Angle LED</p>  <p>IP65 • IK08 505</p>	<p>Antares LED</p>  <p>IP65 • IK08 506</p>	<p>Eta LED</p>  <p>IP65 • IK10 507</p>	<p>Eta LED</p>  <p>LOUVER 507</p>	<p>Oval LED</p>  <p>IP54 • IK08 509</p>	<p>Oval LED</p>  <p>LOUVER 509</p>

Outdoor Accent Luminaires

<p>Theta LED</p>  <p>IP54 • IK08 510</p>	<p>Theta LED GRID</p>  <p>IP54 • IK08 • grid 510</p>	<p>Thuban A LED</p>  <p>IP65 • recessed 511</p>	<p>Thuban B LED</p>  <p>IP65 • recessed 512</p>	<p>Thabit Q LED</p>  <p>IP65 • surface 513</p>	<p>Floor LED</p>  <p>IP67 • inground 514</p>
<p>Atlas LED</p>  <p>IP67 • IK10 515</p>	<p>Atlas S LED</p>  <p>IP67 • IK10 516</p>	<p>Atlas S LED</p>  <p>IP67 • square 516</p>	<p>Atlas S LED</p>  <p>IP67 • cover 516</p>	<p>Kappa LED</p>  <p>IP65 • IK08 518</p>	<p>Kappa LED</p>  <p>IP65 • IK08 518</p>
<p>Apus LED GRO</p>  <p>IP65 • GU10 519</p>	<p>Ancha LED</p>  <p>IP65 • inground 520</p>	<p>Ancha LED</p>  <p>with accessory 520</p>			

Park and Street Luminaires

<p>Nigea LED</p>  <p>IP65 • IK08 524</p>	<p>Nodus LED</p>  <p>IP65 • IK08 526</p>	<p>Sphere LED</p>  <p>IP54 • opal 528</p>	<p>Signus LED</p>  <p>IP65 • IK08 530</p>	<p>Sirius LED</p>  <p>IP66 • IK08 532</p>	<p>Segin LED</p>  <p>IP65 • IK08 533</p>
<p>Squall LED</p>  <p>IP66 • IK08 535</p>	<p>Sargas LED</p>  <p>IP66 • IK08 537</p>	<p>Pole LED</p>  <p>IP66 • IK09 538</p>	<p>Alkes A LED</p>  <p>IP66 • IK08 540</p>	<p>Auva LED</p>  <p>IP66 • IK09 542</p>	<p>Auva LED</p>  <p>IP66 • IK09 542</p>
<p>Avior LED</p>  <p>IP66 • IK09 545</p>	<p>Star B LED</p>  <p>IP65 • basic 547</p>	<p>Alkes B LED</p>  <p>IP66 • IK08 548</p>			

HOW TO USE THIS CATALOG?

NORTHCLIFFE

BOOTES C LED
Surface and Suspended Luminaire

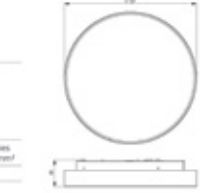
DESCRIPTION: Surface decorative LED luminaire
Light distribution type: direct/indirect
Optical system: Equi Flux/A diffuser/multimicro-prismatic TMAA diffuser, LG2/3D
Housing: steel
Colour: light grey, RAL9005; white, RAL9003; black, RAL9005

GENERAL DATA: Mains voltage: 220-240V, 50/60Hz
LED lifetime: > 100000h @ B50
SQC4: 3
Protection class: IEC 1
Ingress protection code: IP20
Mechanical impact resistance: IK02
Operating temperature range, °C: ta 0...+35

INSTALLATION: On the ceiling, on the wall or suspended (accessories to be ordered separately). Push-in terminal, 3x2x2.5 mm²

ENVIRONMENT: indoor

APPLICATION: Office, education, retail, public place

PRODUCT	DIAMETER, mm	HEIGHT, mm	LUMINAIRE OUTPUT ¹ , lm	SYSTEM POWER ² , W	SYSTEM EFFICACY ³ , lm/W	CRI	CCT, K	WEIGHT, kg
Bootes C LEDx2250 0056 T840 GP	300	92	2227	15.6	143	80+	4000	2.1
Bootes C LEDx2250 0057 T840 GP	300	92	2540	18.0	141	80+	4000	2.1
Bootes C LEDx2900 0056 T840 GP	300	92	2851	20.2	141	80+	4000	2.1
Bootes C LEDx3550 0056 T840 GP	450	92	3824	25.9	148	80+	4000	4.8
Bootes C LEDx4000 0060 T840 GP	450	92	4562	31.0	148	80+	4000	4.8
Bootes C LEDx3550 0061 T840 GP	450	92	5324	36.0	148	80+	4000	4.8
Bootes C LEDx5750 0062 T840 GP	600	92	8737	37.9	192	80+	4000	8.0
Bootes C LEDx6950 0063 T840 GP	600	92	9882	45.7	192	80+	4000	8.0
Bootes C LEDx8050 0064 T840 GP	600	92	8077	52.5	153	80+	4000	8.0
Bootes C LEDx9200 0065 T840 GP	900	92	9752	59.3	164	80+	4000	13.8
Bootes C LEDx10700 0066 T840 GP	900	92	10688	68.7	156	80+	4000	13.8
Bootes C LEDx12250 0067 T840 GP	900	92	12237	79.7	154	80+	4000	13.8
Bootes C LEDx2250 0056 T840 DPx2 LTR0	300	92	2090	15.6	129	80+	4000	2.1
Bootes C LEDx2250 0057 T840 DPx2 LTR0	300	92	2293	18.0	128	80+	4000	2.1
Bootes C LEDx2900 0056 T840 DPx2 LTR0	300	92	2573	20.2	127	80+	4000	2.1
Bootes C LEDx3550 0056 T840 DPx2 LTR0	450	92	3451	25.9	133	80+	4000	4.8
Bootes C LEDx4000 0060 T840 DPx2 LTR0	450	92	4125	31.0	133	80+	4000	4.8
Bootes C LEDx3550 0061 T840 DPx2 LTR0	450	92	4894	36.0	134	80+	4000	4.8
Bootes C LEDx5750 0062 T840 DPx2 LTR0	600	92	8738	37.9	193	80+	4000	8.0
Bootes C LEDx6950 0063 T840 DPx2 LTR0	600	92	4270	45.7	136	80+	4000	8.0
Bootes C LEDx8050 0064 T840 DPx2 LTR0	600	92	7235	52.5	138	80+	4000	8.0
Bootes C LEDx9200 0065 T840 DPx2 LTR0	900	92	8259	59.3	139	80+	4000	13.8
Bootes C LEDx10700 0066 T840 DPx2 LTR0	900	92	9654	68.7	141	80+	4000	13.8
Bootes C LEDx12250 0067 T840 DPx2 LTR0	900	92	10443	79.7	139	80+	4000	13.8

Tolerance range for optical and electrical data: ±5%. Values refer to an ambient temperature of 25°C. NORTHCLIFFE LIGHTING is constantly developing and improving its products. The right is reserved to change any product specifications without prior notification.

72 www.northcliffe.org

Heading:

Name of product family and product group

Pictograms:

Main product characteristics and marking labels

Technical drawing:

A graphic rendition of how the luminaire is built, which includes important dimensions

Pictures:

Images of the product, product family and options

Description:

Product specification, general data, installation and application

Products:

Model names, dimensions, light output, power, efficacy, CRI, CCT and weight data

Accessories:

Available accessories for the product range

Options:

Available modifications of the luminaire

NORTHCLIFFE
making life brighter

AVAILABLE ACCESSORIES:

Product: Suspension MTG KIT SUS
Description: Suspension wire set "Y" type, 1.5m adjustable, 1pc
"Y" - 3x3 MTG SUSKIT for Bootes C LED

Product: Suspension MTG KIT Bootes C LED / Luminaire LED, white/grey/black
Description: Suspension wire set with cap 3x1" type, 1.5m adjustable, 1pc

Product: CAP cable (Ø) D6.3mm SET clear
Description: Cable and suspension wire clip set, 1pc. For cable diameter up to 6.3mm and wire diameter 1mm.

Product: CAP, light grey/white/black
Description: Square decorative metal cap for fixing cable meet with suspension wire attachment point, push-in terminals 3x1x2.5mm², light grey/white/black



Product: CAP, light grey/white/black
Description: Square decorative metal cap for fixing cable meet with suspension wire attachment point, push-in terminals 3x1x2.5mm², light grey/white/black

OPTIONS AVAILABLE ON REQUEST:

LED	REFLECTOR AND OPTICS	CONTROL GEAR	SENSOR	EMERGENCY	CONNECTION	OTHER	COLOR
T830	CP	DALI	MWP	EM3 ¹	CSF3.2.0m clear	Direct	RAL
T840	DPx2 LTR0	EA8B-M ² ††		EM3 ¹	CSF3.2.0m clear	Fabric (T...100mm)	
		EA8B-S ² ††		EM3A ¹		Fabric (T...100mm)	
		BLT		EM3 ¹			
		CDP					
		CO2HWP					
		CO2SHWP					

1 Ingress protection IP20
2 RMR system size 1x EA8B-M + 3x EA8B-S
3 Max wire length from EA8B-M to last EA8B-S: 0m
4 EA8B option not applicable for models: 0056, 0057, 0058, 0060, 0062
5 CDP options not applicable for models: 0066, 0067, 0068
6 MWP option not applicable for models: 0056, 0057, 0058
7 EM options not applicable for models: 0056, 0057, 0058

CP **DPx2 LTR0**

73 www.northcliffe.org

Light distribution curves:

Photometric light characteristics of the products or range of products

Applications:

Pictures to give some ideas for architects and designers

BOOTES C LED 1X 2250 G556 T840 DPRZ LT80

Family name:

Bootes C LED

Quantity of modules:

1x

Luminaire light output:

2250lm

Note: rounded luminaire output divided by number of modules, if quantity of modules higher than one

Factory code:

G556

Light source:

T840 Colour temperature 4000K, CRI 80+

Options:

DPRZ LT80 De-glaring micro-prismatic diffuser with matt light scattering layer

ICON LEGEND:



LED light source



Mains voltage



I-st class protection from electric shock



II-nd class protection from electric shock



III-nd class protection from electric shock



Degree of protection from dust and water ingress



Degree of mechanical impact resistance



Suitable for chemically aggressive environments



Suitable for industrial environments



European Norms Electrical Certification (ENEC) is used for electrical products that demonstrates compliance with European standards



Vandal resistant



Housing of the luminaire does not warm up above 90°C



Unified Glare Rating



Luminaire fits to LG3 requirements (with direct/indirect light distribution)



The Ex marked luminaires ensure safety and prove their compliance with the relevant legal regulations for explosive environments



Conformity with European Union standards



The United Kingdom Conformity Assessment (UKCA) mark is used to identify products suitable for sale within England, Scotland and Wales



Suitable for sports facilities

INTRODUCTION



LED, TECHNOLOGY OF THE FUTURE

LED TECHNOLOGY

When it comes to lighting, we are in the most revolutionary period since Thomas Edison's creation of the light bulb. The technology of LED lighting has grown rapidly over the past few decades. It has become a mainstay in commercial, industrial spaces, schools, hospitals, and even residences, thanks to the numerous features which make it superior to any other traditional light sources allowing savings of up to 90% of electricity for the same amount of emitted light.

The luminous efficiency of LEDs continues to reach higher values and already theoretical border of 300 Lumens per Watt is achieved in laboratory conditions.

LEDs are semi-conductor diodes which, when electricity passes through them, emit a monochromatic light. The Colour of the light depends on the type of impurity purposely inserted into the chip.

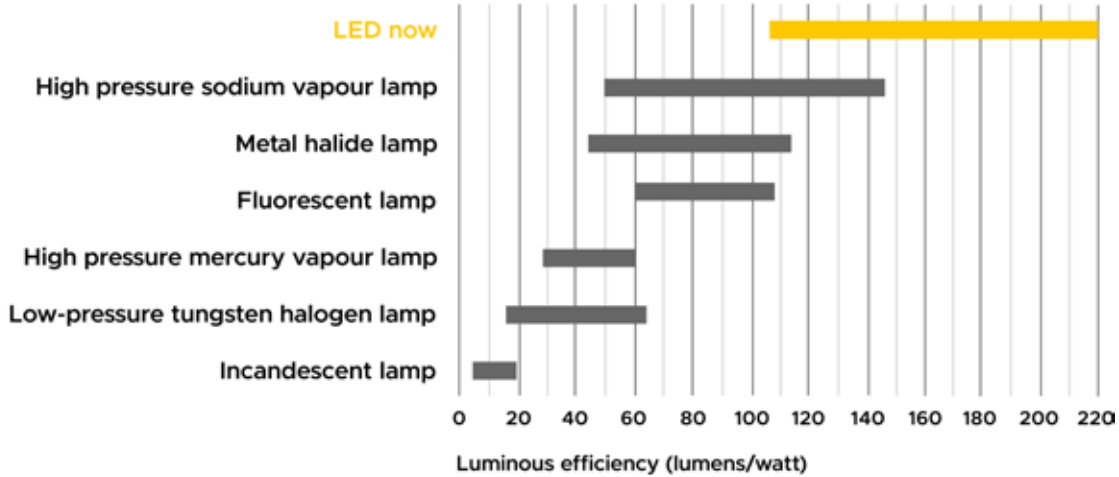

LONG LIFE TIME

Why Is the LED Industry Growing So Fast?

- LED lights have longer lifespans. They can last as long as 100 000 hours, approximately equivalent to 30 years, without malfunctioning
- LED lights save greatly on energy consumption and consecutive power costs, saving up to 90% in energy costs
- LED lights offer a wide range of features for customers like dimming capabilities, changing light colour, remote control
- LED is an eco-friendlier option

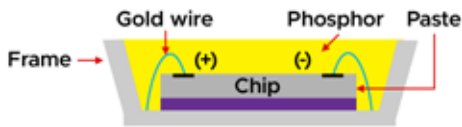

Besides bottom-line cost savings, intelligent or smart LED systems can have an immense impact on production efficiency, sustainability and massively contribute to overall facility performance.

HUMAN CENTRIC LIGHTING

Human centric lighting refers to the consumers and businesses using LED technology to create the most effective and desirable environment. The most straightforward measure to achieve this environment is through colour changing LEDs. LED light is often a better option due to the broader quality of light and smoother colour spectrum, which is closer to that of the sun than other artificial lights. Ultimately, installing LED lights that can change colour and smart LED systems to automate this process, consumers can have more blue light during the day, and more warm light during the later hours, simulating natural light from the sun. Researchers correlate exposure to natural-like colours to better mental states and increased productivity. Another significant measure to develop effective and desirable environments is the dimming feature and occupancy sensing capability. Not only can LEDs change colour, but they can also be dimmed, resulting in a smoother and better flow alongside natural light. Occupancy sensors, generally fitted with motion or heat sensing technology, are essential to reduce unnecessary operation of lights and ultimately, unnecessary power consumption. This measure is not only convenient and cost efficient, but also great for the environment.

IOT – THE INTERNET OF THINGS

This term refers to the ever-expanding range of devices that support internet connectivity, and can communicate via the internet. This connectivity simplifies and automates the much-needed process of controlling large quantities of lights and complex spaces in simple control structures. However, that would hardly be the only IoT application. IoT compatible LED lighting could be the core of systems that optimize air conditioning and heating, power grid management, and even next-generation wireless communications.

LiFi

LiFi is the most recent and industry-changing concept in lighting. The basic concept of LiFi is the use of lights rather than radio waves to transfer data, with proven transfer speeds up to 100 times faster! Having Li-Fi integrated into the LED lighting would create an alternate path for internet connectivity in commercial spaces and offices, where internet connectivity can sometimes pose a problem.

ILLUMINATION CONTROL SYSTEMS

Light plays a huge role in today's world and it goes far beyond the limits of simple illumination. However, it seems rather difficult to control such miracles as multifunctional illumination or light atmosphere changes in accordance with the situation. This problem could be solved by implementation of an illumination control system. Northcliffe offers illumination control systems, designed and developed by the leading European companies. Illumination control system unites all the light sources in the building and gives an opportunity to control each of them individually from any location. Such system allows to reach the full potential of illumination control, starting from the control in one room and extending to its control in as many premises as necessary, even while having difficult configurations. Illumination control system could be integrated into the general control scheme of other components, such as an alarm system, media etc., in such way improving the efficiency of service.

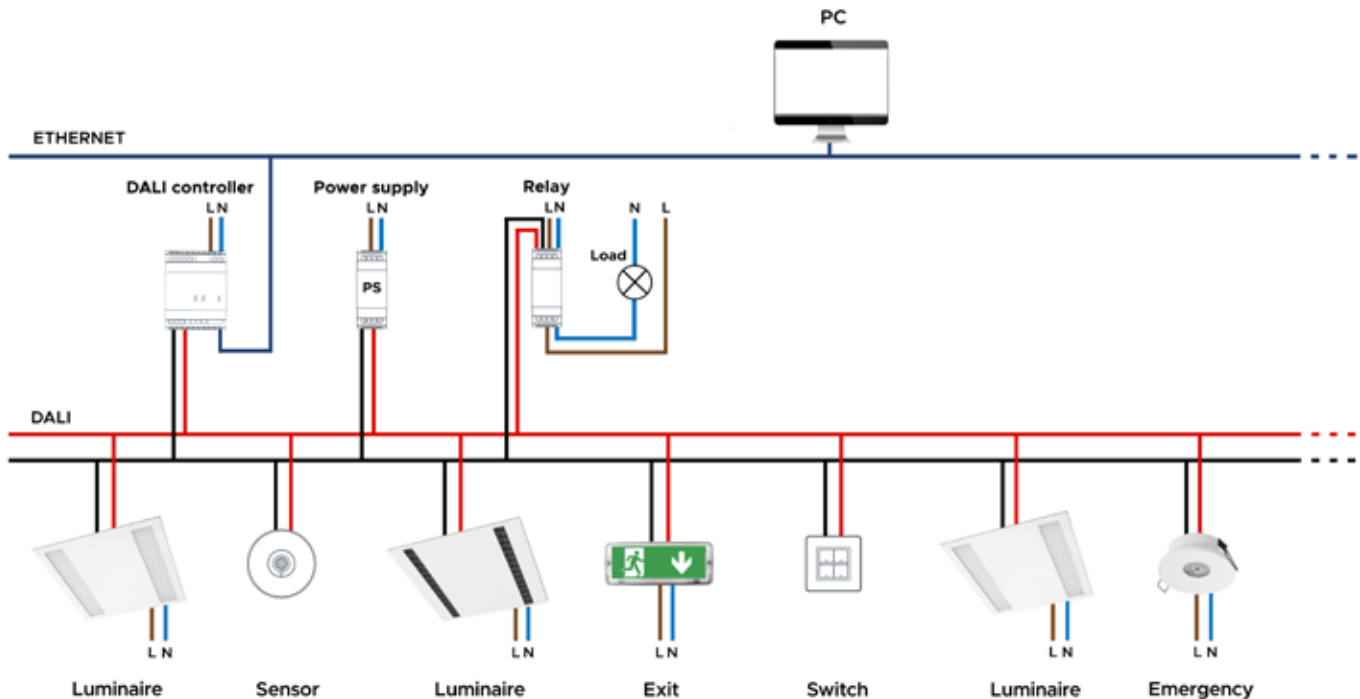

The cost-effectiveness and possibility of illumination sources self-adjustments seems to be one more obvious benefit of the system. The range of illumination control systems is quite wide. The simplest one is a standard combination of several light scenarios, pre-programmed in the central control unit. This option is the best solution for small premises, such as cafes, separate rooms in the apartments, cottages, offices, director's rooms, presentation rooms, bars, saunas, restaurants, cinemas, boutiques etc. Upon the requests of a client, the system could be adjusted to a more sophisticated one. In such case, a special illumination design is drawn. Such individual complex designs are realized through the adoption of multiple control units corresponding between each other. The more difficult project is, the easier solution with the help of illumination control system can be provided.

ENERGY SAVINGS WITH ILLUMINATION CONTROL SYSTEMS



Sensors ensure lighting is only on when and where it is needed. The sensors can bring huge benefits in terms of energy management as they enable sunlight harvesting, automatic dimming, and sensing the presence of people. The lighting is only on when actually required so cost savings are considerable. Energy savings - typically between 30% and 50%. Application: ideal for all office areas including work spaces, conference rooms, corridors, break-out rooms, administrative areas, stairwells and similar applications in schools and hospitals. For more information see the option list and energy saving solutions

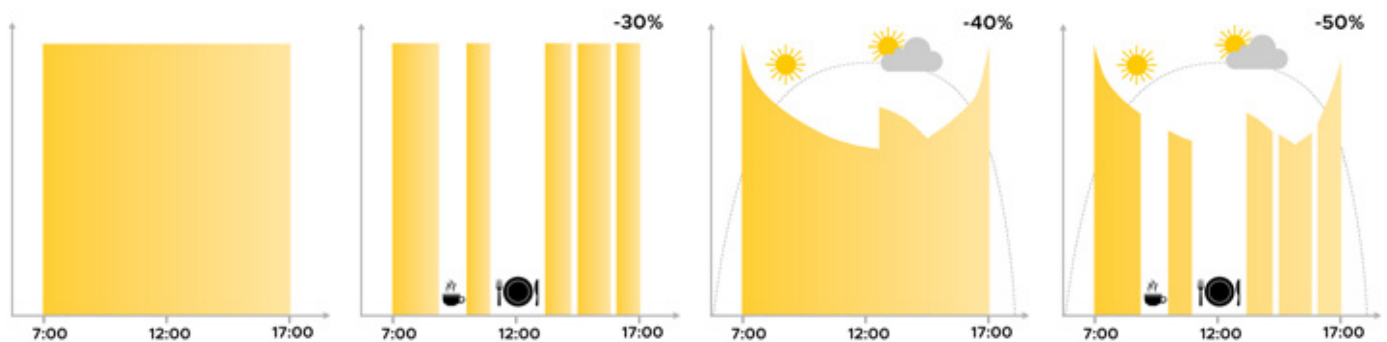

SDIM SOLUTION

SDIM, also known as a touch control with a push button, is a system that enables the simple and economic dimming of luminous flux. It uses the mains voltage as a control signal, applying it with a standard push button on a control line, without any need for specific controllers. SDIM enables you to perform the basic functions of a regulation system with a power-free pushbutton. It is possible to switch the luminaires on or off or dim them, depending on how long the button is pressed. Switching the light on or off is done by short, sharp pressing or “click”. If the button is pressed for a longer time it is possible to dim the luminous flux between the maximum and minimum levels alternately.

COST EFFECTIVE MEETING ROOM

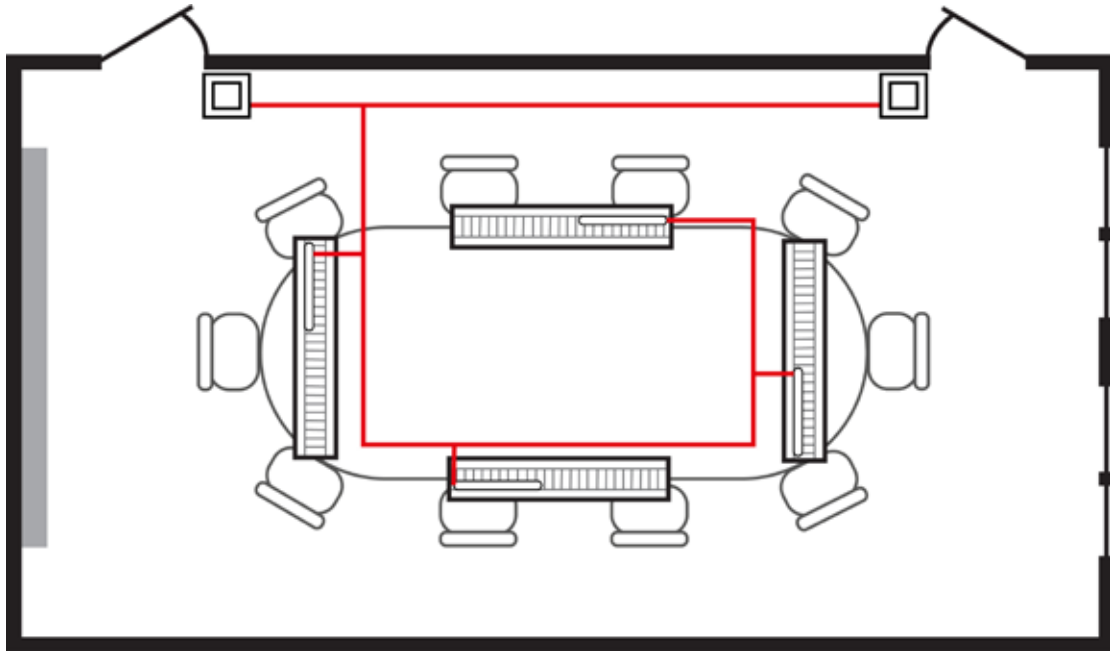

PIR VS MICROWAVE SENSORS: WHAT'S THE DIFFERENCE?

Motion sensors are integral components of security systems, smart offices, and energy-efficient lighting solutions. They work by detecting movement within their field of view and triggering a response, such as turning on a light or activating an alarm. There are two primary types of motion sensors: Microwave and Passive Infrared (PIR).

Passive InfraRed detection



PIR

Passive Infrared (PIR): A line of sight beam that reacts to heated motion across a field of view. When a difference in temperature is detected by one of the beams, the sensor is activated, switching on the lights. When all the beams sense the same temperature again, the lights will switch off. It is a type of sensor technology, where no energy is emitted from the sensor.

Microwave detection



MICROWAVE

Microwave (MW): It is a type of sensor technology, which sends out microwave pulses (active) and measures the reflection off a moving object. Similar to a police radar gun. A person moving into the detection zone causes a disruption in the microwave beam, changing the echo time and triggering the lights.

FEATURE	PIR	MW
Sensitivity	Moderate	High
Penetration	Requires line of sight	Can detect through non-metallic materials
Detection range	360°	360°
Energy consumption	Lower	Higher
False alarm rate	Lower	Higher

LIMITATIONS OF PIR SENSORS:

- **Limited detection range:** PIR sensors have a shorter detection range than microwave sensors, which can be a disadvantage in large or open spaces.
- **Line-of-sight requirement:** PIR sensors cannot detect movement through walls or other solid objects, as they rely on infrared radiation, which is absorbed by most materials. Can be less sensitive when walking directly towards sensor.
- **Temperature sensitivity:** PIR sensors can be affected by sudden changes in ambient temperature, which may lead to false alarms or missed detections.

LIMITATIONS OF MW SENSORS:

- **Potential for false alarms:** their high sensitivity can lead to false alarms triggered by minor movements, like a swaying tree branch, vibration.
- **Energy consumption:** MW sensors consume more power than PIR sensors, which may impact long-term energy costs.
- **Interference:** other electronic devices emitting radio waves can interfere with the sensor's signal, reducing its effectiveness.

OCCUPANCY CONTROL



Occupancy control:
When movement is detected, the load will automatically turn on. When the area is no longer occupied the load will automatically switch off after an adjustable time period.

ABSENCE DETECTION

It is easy to forget to switch off the light, in office, corridor, even at home. And in many other cases, people do not want to have a sensor to switch on the light automatically, for example, when people just quickly pass-by, there is no need to have the light on. The solution is to apply this “absence detector”: motion sensor is employed, but only activated on the manual press of the push switch, the light keeps being ON in the presence, and switches off/dims down in the long absence.



Absence Detection:
Upon entering the room, the person switches on the light as normal, when no movement is detected, the detector switches off the lighting automatically. Lights can also be switched off manually.

DAYLIGHT THRESHOLD

Sensors provide simple switching of the light based upon occupancy. A daylight sensor is also built-in to prevent the light switching on when there is sufficient natural light.



No presence detected, daylight, lights off



Presence detected, sufficient daylight, lights off



Presence detected, insufficient daylight, all lights on



No presence detected, lights off

DAYLIGHT MONITORING



Motion sensors with Daylight Monitoring are able to achieve that luminaire be automatically switched on at sunset and be automatically switched off at sunrise, even without movement triggering.

21:00



1. The light switches on at 100% when there is movement detected.

21:10



2. The light dims to stand-by level after the hold-time.

21:40



3. The light remains in dimming level at night.

1 ↔ 3 goes in cycle at night ... 100% on when movement detected, and dims to 10% in long absence

08:10



4. The light turns off completely when natural light lux exceeds daylight threshold pre-set.

17:40



5. The light automatically turns on at 10% when natural light is insufficient (no motion).

DAYLIGHT HARVESTING

Right time, right place and the right amount of light. Daylight harvesting is a must in the future lighting norms. Daylight harvesting sensors use daylight to offset the amount of artificial lighting needed to properly light a space, in order to reduce energy consumption and reach the target lux level. This is accomplished using lighting control systems that are able to dim or switch the lighting in response to changing daylight availability.

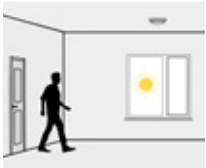

Light will not switch on when natural light is sufficient, even there is motion detected.



The light switches on automatically with presence when natural light is insufficient.



The light turns on at full or dims to maintain the lux level. The light output regulates according to the level of natural light available.



The light will be switched off when the ambient natural light is sufficient.



The light dims to stand-by brightness after hold-time and stays on the selected minimum dimming level.



The light switches off automatically after the stand-by period.

SYNCHRONISATION

Synchronisation mode is useful when several sensors are connected together to control the same fixtures. By connecting the synchronisation terminals in parallel (maximum 10 units, see diagram), no matter which sensor detects motion, all sensors in the group will turn on the lights (ambient natural light is below daylight threshold). The detection area is widely enlarged in this way while other settings such as hold-time, stand-by period, stand-by dimming level and daylight threshold on each individual unit stay the same.

With sufficient natural light, the lights does not switch on when presence detected.

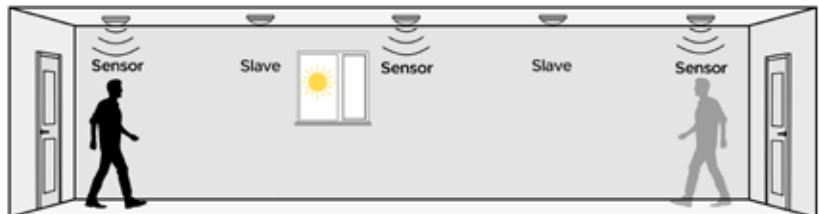

With insufficient natural light, the person comes from any direction, the whole group of lights switch on.

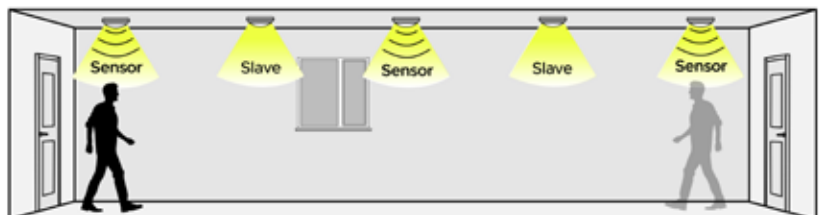

The lights dim to stand-by level after hold-time, or turn off completely if surrounding natural light is sufficient.

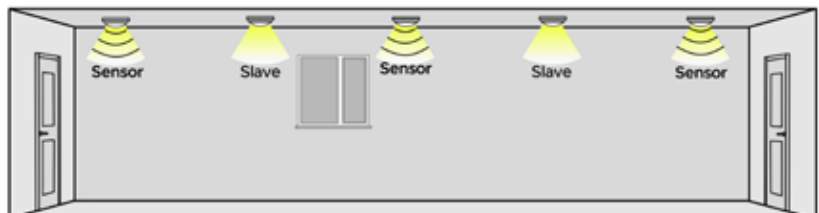

The lights switch off automatically after the stand-by period.

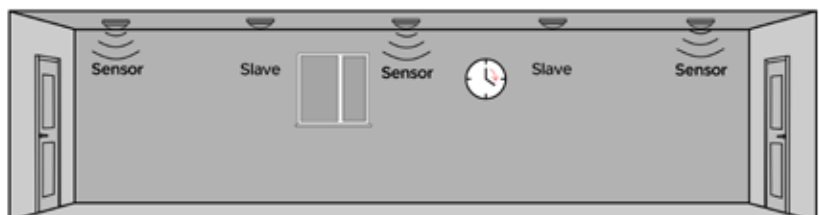

CORRIDOR FUNCTION

Luminaires with built in corridor function are a very simple and highly efficient way of reducing energy consumption. Wherever light has to be provided 24-hours a day for statutory reasons, the corridor function helps provide the right light, combined with energy-efficient and cost-effective operation. Automatic switching is based on presence/motion with the time delay set on site to suit the customers' requirements, where no presence is detected, the light level will fade from 100% down to 10% saving up to 60% of the energy usage. The corridor function does not abruptly switch off the lighting but dims it to a 10% level. Depending on the profile selected the device remains at this light level ("never off" profile) or switches off completely after the appropriate delay ("Switch off" profile).

This economical form of 24-hour lighting is ideal for pedestrian underpasses, underground train stations, stairwells, ATM booths, telephone kiosks, hotels, public buildings and hospitals.

OPTION	DESCRIPTION
COR	Driver with Corridor function (never off)
COR1min	Driver with Corridor function 1min (switch off after 1 min)
COR30min	Driver with Corridor function 30min (switch off after 30 min)
eCOR MW	Driver with MW sensor and adaptive corridor function (100%/10-30%/0%)

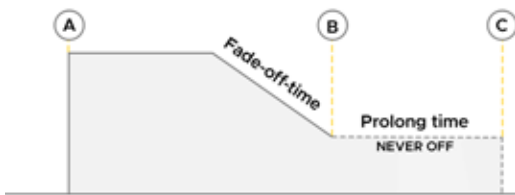

COR option:

Standard profile "Never OFF" (A...100%, B...10%, fade time 32 s, never OFF). If presence/motion is not detected, from this time onwards the driver dims until the absence light value is reached. This corresponds to the default parameters.

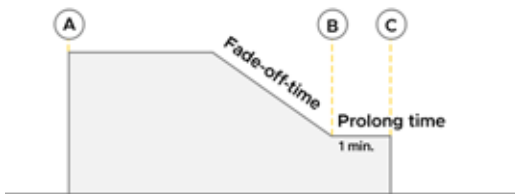

COR1min option:

Profile 2 "Switch off" (A...100%, B...10%, fade time 32 s, switch off after 1 minute). If presence/motion is not detected, from this time onwards the driver dims until the absence light value is reached and if presence is not detected in the next minute the driver switches off completely.

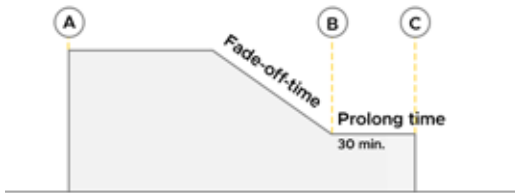

COR30min option:

Profile 3 "Switch off" (A...100%, B...10%, fade time 32 s, switch off after 30 minutes). If presence/motion is not detected, from this time onwards the driver dims until the absence light value is reached and if presence is not detected in the next 30 minutes the driver switches off completely.

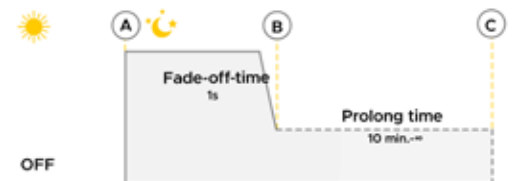

eCOR MW:

Profile 4 "Adaptive" (A... 100%, B...10/30%, fade time 1s, switch off never off/10min/off in daylight). System driver + sensor. If daylight mode is active - sensor will not detect motion. Once ambient light becomes insufficient system could be set as switch off (lights will switch off after 10 mins of absence) or never off (lights will remain on at absence light level).

HUMAN CENTRIC LIGHTING



Human Centric Lighting works with the people occupying the space to create the most effective environment for them. This can be done in several different ways. The first is colour tuning for LED luminaires. An LED light typically provides a significant improvement in the quality of light because its broad, smooth colour spectrum is more similar to the sun's colour spectrum than other artificial light sources. The colour of light works with the natural circadian rhythms of human beings (wake and sleep cycle). Blue light, which is typically more present in LED lighting (and the sun) than in incandescent lighting, for example, helps combat fatigue and creates an overall sensation of being awake by suppressing the production of melatonin, the body's natural sleep hormone. Red-rich lighting, on the hand, which has much less blue content, and can also be produced by LEDs, can help promote a sense of sleepiness by allowing the production of melatonin. LED colour tuning technology can be beneficial, for example, for hospital lighting. Luminaires tuned to blue-rich LED lighting can help keep nursing staff alert during night shifts, while LED lighting in a patient's room can be tuned to more restful red-rich lighting.

The second and third types of Human Centric Technology include dimmable and occupancy sensing capabilities. The LED light would sense the ambient light in the room and adjust the brightness of the light based upon the available light coming in from windows or other sources. This technology has wide applicability from retail stores to industrial warehouses and more. Occupancy sensing helps decrease the amount of energy spent illuminating rooms that have no one in them. This could either be done by motion or presence sensing. Both of these technologies are not just helpful for individuals, but it is also beneficial for the environment. Dimming lights and turning off lights when there is no occupancy, greatly decreases the amount of energy used, both helping the planet by creating less greenhouse gas as well as adding money to a company's bottom line.

OPTION	DESCRIPTION
TW	Integrated light source and driver for Tuneable white control 2700-6500K
BLT TW	Integrated light source, wireless control unit and driver for Tuneable white control 2700-6500K via mobile device (via Bluetooth®)

CCT change using LED light sources can be obtained, mixing warm and cool light by adjusting opposite sides intensity. It also can be obtained mixing some specific colour LED's, getting better results, but at much higher costs.

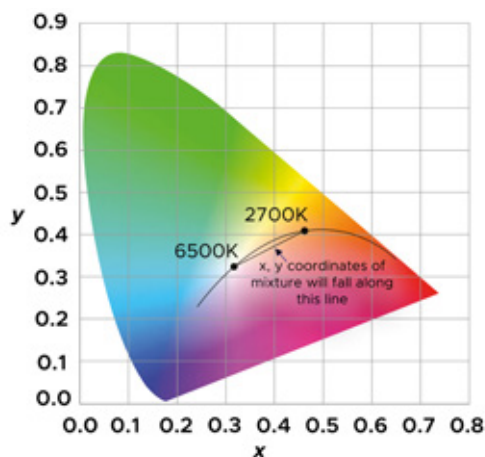

Two-Colour temperature (2700K or 6500K) light source possible coordinate change of range and deviation from Planckian curve

BENEFITS AND MERIT OF HC:

- Individual, human centred illumination
- Natural light simulation
- Better comfort, health, productivity and sleep
- Supports circadian circle
- HCL can be implemented as standalone, as well as bigger systems solution

HUMAN CENTRIC LIGHTING CONTROL OPTIONS:

There are two simple ways to control dimming and Kelvin or Colour changing:

- Using Bluetooth® pre-programmed curves
- Using a smart device like smartphone or a tablet
- Using a push button (switch dimming)

Different from other complex lighting systems, NORTHCLIFFE offers a simple de-centralized human centric lighting solution for offices, schools and hospitals with the tuneable white feature. The solution is based on Bluetooth® together with an intuitive and portable app, and does not require any complicated PC tools to set up and configure. The controlled light output can enhance a user's day-to-day mood, wellbeing, productivity and attention levels. Users can simply choose our pre-programmed curves in the app, or create a new curve with colour temperature (CCT) and brightness automatically changing according to the time of day.

SYSTEM DEFAULT PROFILE FOR OFFICE

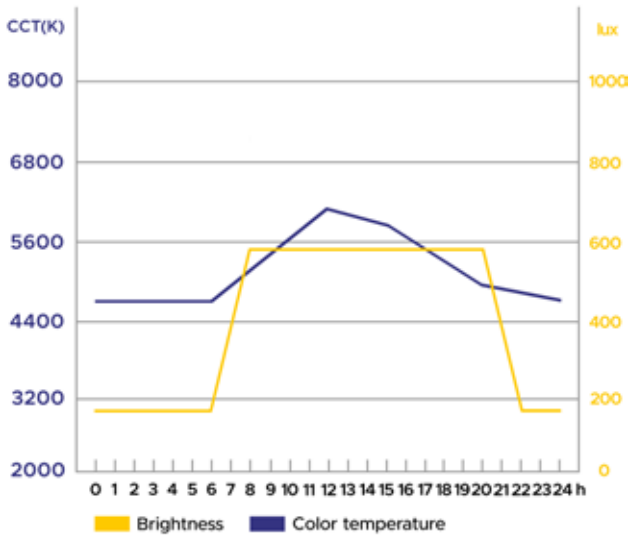

SYSTEM DEFAULT PROFILE FOR HEALTHCARE

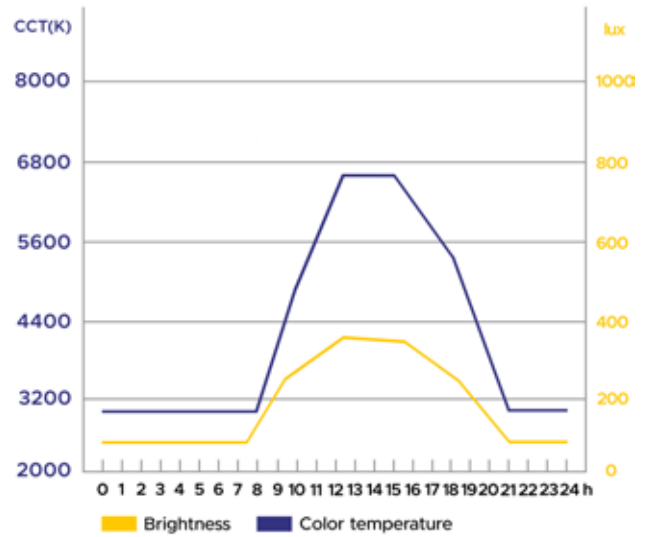

OFFICE APPLICATION

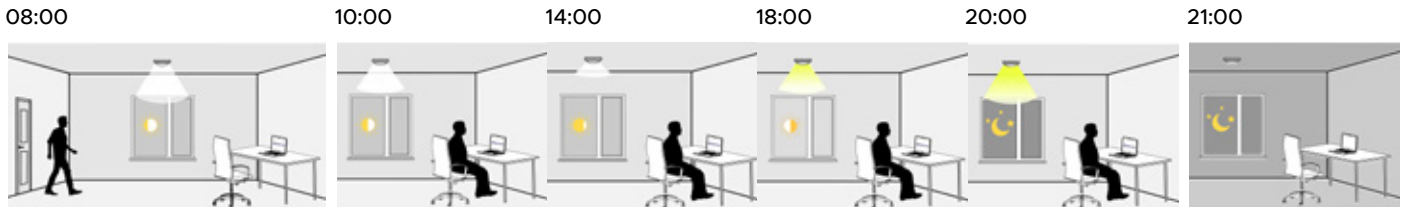

The light switches on automatically with presence when natural light is insufficient.

The light turns on at full or dims to maintain the lux level. The light output regulates according to the level of natural light available.

The light switches off completely after stand-by time when there is no movement detected.

HEALTH CARE APPLICATION

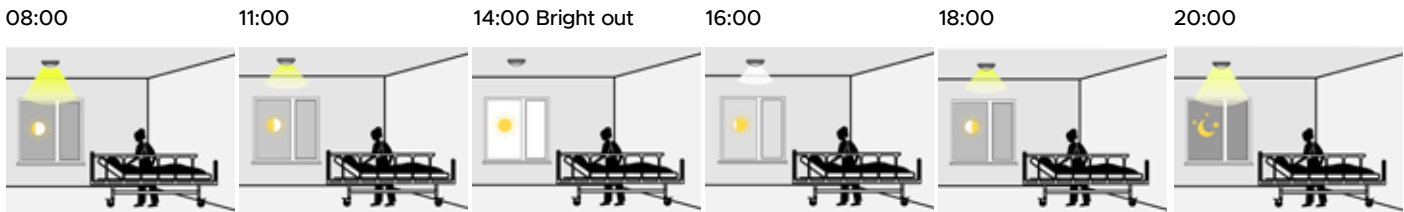

INDEPENDENT PIR SENSORS

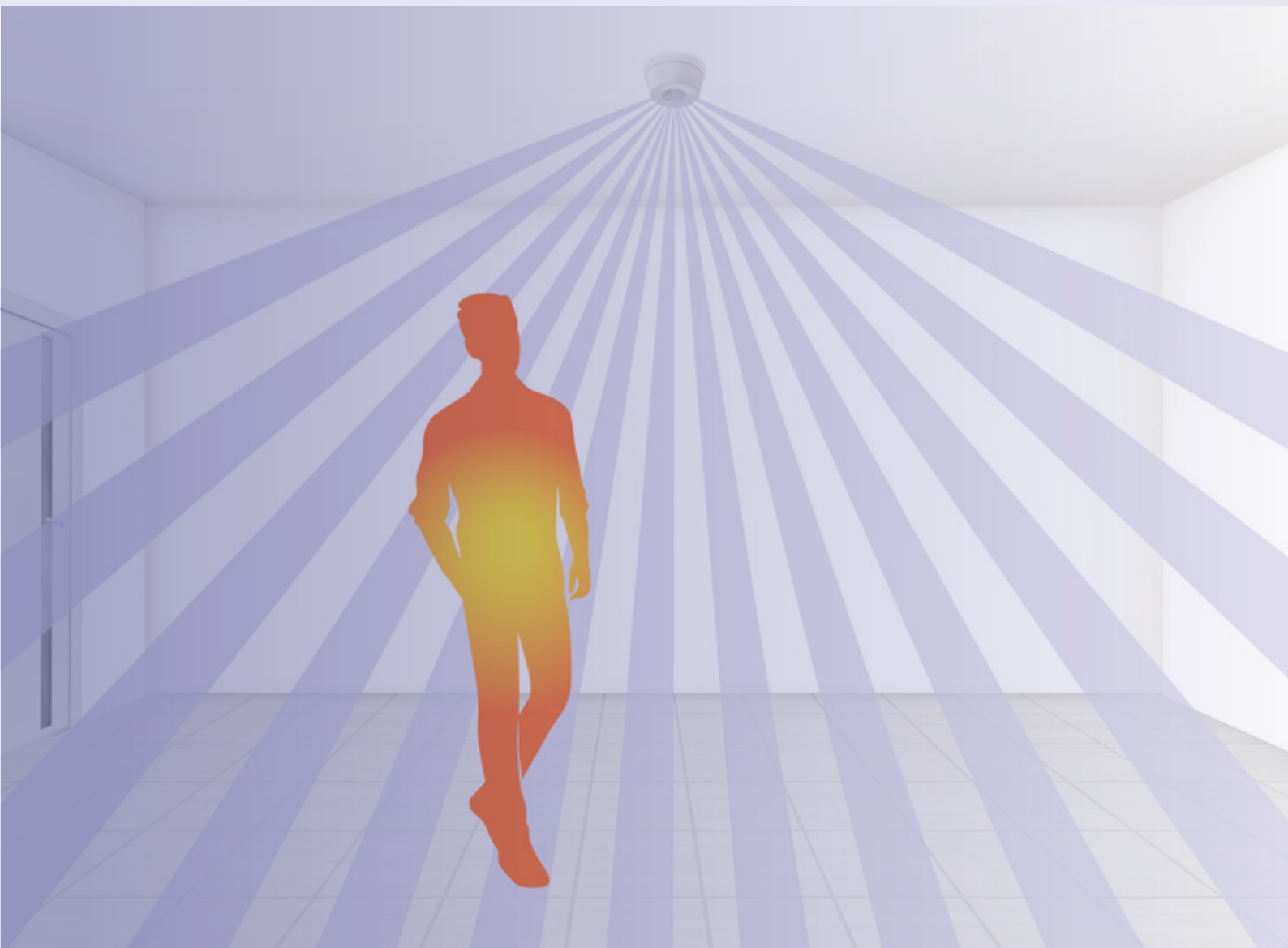

DALI STANDALONE SENSORS

Designed to simplify lighting, our simple DALI-2 sensors allow automatic control of DALI lighting 'out of the box': no programming, no additional controllers, no system required. Easy to wire, expand or remove, according to changing client needs.

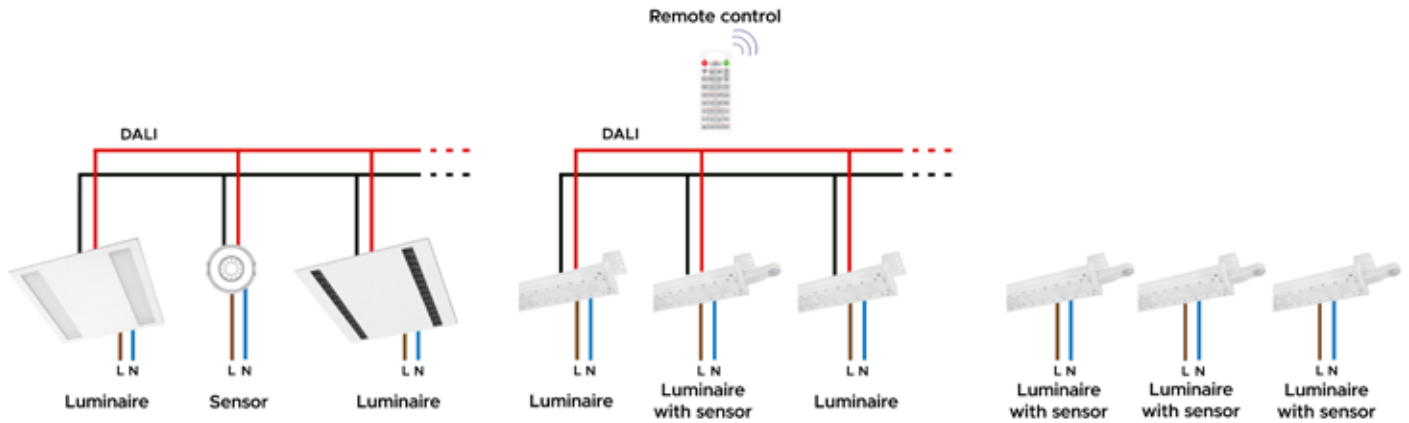

SENSOR R RPIR360 D8/4 W

Recessed-Mounted PIR Sensor



DESCRIPTION:	Recessed-mounted PIR sensor Body: polycarbonate, white Detection range: 360° Detection diameter: 8m max. (<24°C) Installation height: 2.2-4.0m
FEATURES:	Occupancy control Daylight threshold
GENERAL DATA:	Mains voltage: 220-240V, 50-60Hz Switching cycles: 100000 Protection class IEC: II Ingress protection: IP54/40 Operating temperature range, °C: -20...+40 Switching load: 600W Power consumption: 0.5W Ambient Light: 3-2000lx (adjustable) Time delay: 10s-15min (adjustable) Movement speed: 0.6-1.5m/s
INSTALLATION:	In ceilings with cut-out openings (Ø63-66). Screw terminal, 3x1x2.5 mm ²
ENVIRONMENT:	Indoor/outdoor with roof
APPLICATION:	Office, education, hotel, corridor, staircase, bathroom, public place

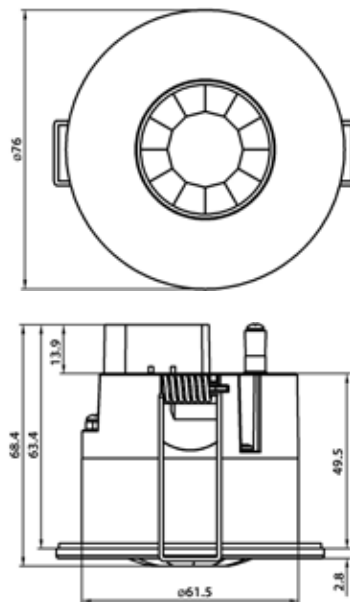

PRODUCT	LENGTH, mm	WIDTH, mm	HEIGHT, mm	DETECTION RANGE, °	MAX. DIAMETER, m	MAX. HEIGHT, m
Sensor R RPIR360 D8/4 W	76	76	68	360	8	4

DETECTION DIAGRAM:

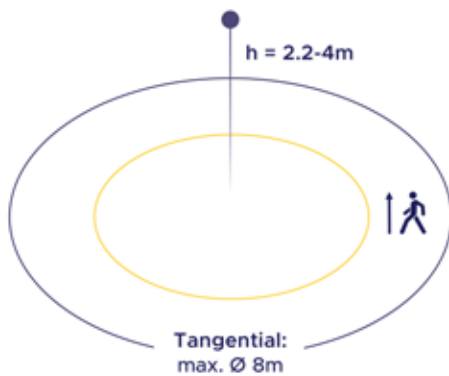



SENSOR C SPIR360 D8/4 W

Ceiling-Mounted PIR Sensor



DESCRIPTION:	Ceiling-mounted PIR sensor Body: polycarbonate, white Detection range: 360° Detection diameter: 8m max. (<24°C) Installation height: 2.2-4.0m
FEATURES:	Occupancy control Daylight threshold
GENERAL DATA:	Mains voltage: 220-240V, 50-60Hz Switching cycles: 100000 Protection class IEC: II Ingress protection: IP65 Operating temperature range, °C: -20...+40 Switching load: 1000W Power consumption: 0.5W Dimensions: Ø110x27mm Ambient Light: 3-2000lx (adjustable) Time delay: 10s-30min (adjustable) Movement speed: 0.6-1.5m/s
INSTALLATION:	On the ceiling. Screw terminal, 4x2.5 mm ²
ENVIRONMENT:	Indoor/outdoor with roof
APPLICATION:	Office, education, hotel, corridor, staircase, bathroom, industry, warehouse, public place, underground passage, parking area

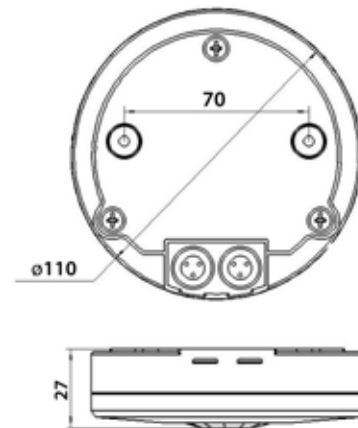

PRODUCT	LENGTH, mm	WIDTH, mm	HEIGHT, mm	DETECTION RANGE, °	MAX. DIAMETER, m	MAX. HEIGHT, m
Sensor C SPIR360 D8/4 W	110	110	27	360	8	4

DETECTION DIAGRAM:

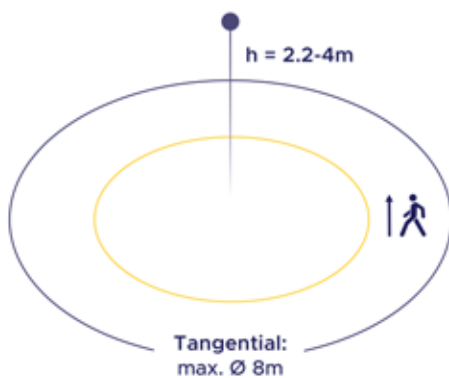

SENSOR C SPIR360 D20/4 W

Ceiling-Mounted PIR Sensor



DESCRIPTION: **Ceiling-mounted PIR sensor**
Body: polycarbonate, white
Detection range: 360°
Detection diameter: 20m max. (<24°C)
Installation height: 2.2-4.0m

FEATURES: **Occupancy control**
Daylight threshold

GENERAL DATA: **Mains voltage:** 220-240V, 50-60Hz
Switching cycles: 100000
Protection class IEC: II
Ingress protection: IP65
Operating temperature range, °C: -20...+40
Switching load: 1000W
Power consumption: 0.5W
Dimensions: Ø115*47.5mm
Ambient Light: 3-2000lx (adjustable)
Time delay: 10s-30min (adjustable)
Movement speed: 0.6-1.5m/s

INSTALLATION: On the ceiling. Screw terminal, 4x2.5mm²

ENVIRONMENT: Indoor/outdoor with roof

APPLICATION: Office, education, hotel, corridor, staircase, bathroom, industry, warehouse, public place, underground passage, parking area

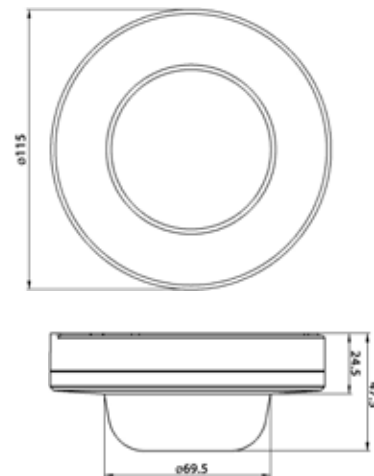

PRODUCT	LENGTH, mm	WIDTH, mm	HEIGHT, mm	DETECTION RANGE, °	MAX. DIAMETER, m	MAX. HEIGHT, m
Sensor C SPIR360 D20/4 W	115	115	48	360	20	4

DETECTION DIAGRAM:

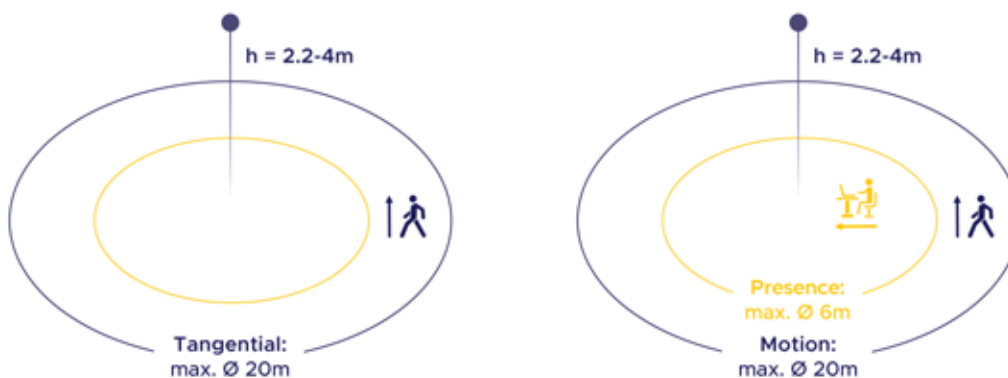

SENSOR W SPIR180 R12/2.5 W

Wall-Mounted PIR Sensor



DESCRIPTION:	Ceiling or wall-mounted PIR sensor Head: tilting angle $\pm 90^\circ$ Body: polycarbonate, white or black Detection angle: 180° Detection radius: 12m max. ($< 24^\circ\text{C}$) Installation height: 1.8-2.5m
FEATURES:	Occupancy control Daylight threshold
GENERAL DATA:	Mains voltage: 220-240V, 50-60Hz Switching cycles: 100000 Protection class IEC: II Ingress protection: IP65 Operating temperature range, °C: -20...+40 Switching load: 600W Power consumption: 0.5W Dimensions: 92x76x62.5mm Ambient Light: 3-2000lx (adjustable) Time delay: 10s-15min (adjustable) Movement speed: 0.6-1.5m/s
INSTALLATION:	On the wall. Push-in terminal, 3x2x2.5 mm ²
ENVIRONMENT:	Indoor/outdoor
APPLICATION:	Office, education, hotel, corridor, staircase, bathroom, industry, warehouse, public place, underground passage, parking area

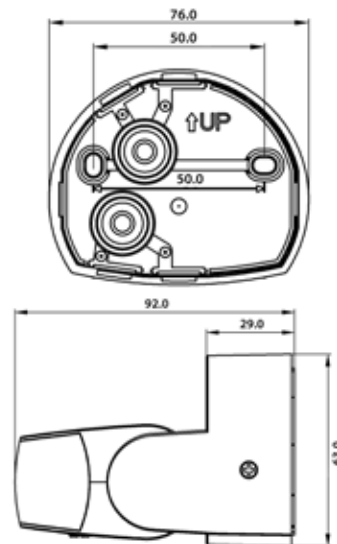

PRODUCT	LENGTH, mm	WIDTH, mm	HEIGHT, mm	DETECTION RANGE, °	MAX. RADIUS, m	MAX. HEIGHT, m
Sensor W SPIR180 R12/2.5 W	92	76	63	180	12	2,5
Sensor W SPIR180 R12/2.5 B	92	76	63	180	12	2,5

DETECTION DIAGRAM:

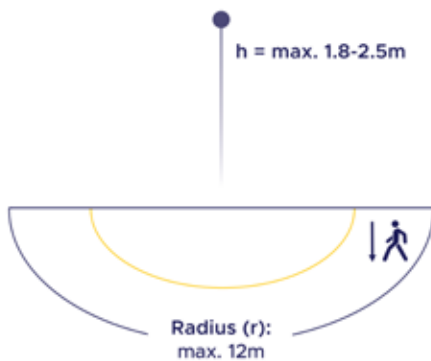

Integrated PIR (Option)

Build-in PIR Sensor



DESCRIPTION:	Build-in PIR sensor Body: polycarbonate, white Detection range: 360° Detection diameter: 6m max. (<24°C) Installation height: 2.2-4.0m
FEATURES:	Occupancy control Daylight threshold
GENERAL DATA:	Mains voltage: 220-240V, 50-60Hz Switching cycles: 100000 Protection class IEC: II Ingress protection: IP65 Operating temperature range, °C: according to product data sheet Switching load: 400W Power consumption: 0.5W Dimensions: 55.4x36.8x25.5mm Ambient Light: 10/2000lx (selectable) Time delay: 5s/30s/1min/3min/5min/8min (selectable) Movement speed: 0.6-1.5m/s
INSTALLATION:	Build into the luminaire
APPLICATION:	Office, education, hotel, corridor, bathroom, public place

OPTION	LENGTH, mm	WIDTH, mm	HEIGHT, mm	DETECTION RANGE, °	MAX. DIAMETER, m	MAX. HEIGHT, m
PIR	18	18	10	360	6	4

DETECTION DIAGRAM:

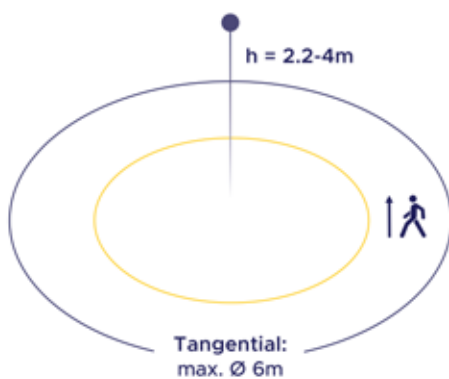

AVAILABLE WITH*:

Eridanus R LED

Calima R LED

Etesian S/U LED

Calima S LED

Bali S/U LED

Serpens LED

Decor LED



*For detailed information refer to luminaire family TDS

and others...

Batten-fit HBPIR (Option)

Build-in PIR High-bay Sensor



DESCRIPTION: **Build-in PIR High-bay sensor**
Body: thermoplastic, light grey
Detection range: 360°
Detection diameter: 16m max. (<24°)
Installation height: 15m

GENERAL DATA: **Mains voltage:** 220-240V, 50-60Hz
Protection class IEC: II
Ingress protection: IP65
Operating temperature range, °C: according to product data sheet
Switching load: 800W
Control output: on/off / DALI / DALI2 / Bluetooth® optional
DALI power supply: 30mA (up to 15 drivers)
Bluetooth® range: 10-30m
Power consumption: <1W
Ambient Light: 2/10/50/100/300/500lux or disable (selectable)
Hold time: 30s/1min/5min/10min/15min/20min/30min (selectable)
DALI stand-by time: 0/10s/1min/5min/10min/30min/1h/+∞
Movement speed: 0.6-1.5m/s

INSTALLATION: Build into the luminaire

APPLICATION: Industry, warehouse, cold store, hall

*When used in -35°C...-20°C environment, the sensor still functions, but the detection range and life-span would be compromised

OPTION	LENGTH, mm	WIDTH, mm	HEIGHT, mm	DETECTION RANGE, °	MAX. DIAMETER, m	MAX. HEIGHT, m
HBPIR15m-M	107	40	29	360	16	15
FEATURES:	ON/OFF Occupancy control Daylight threshold Remote control					
DALI HBPIRD15m-M	107	40	29	360	16	15
FEATURES:	DALI output Occupancy control Absence detection Daylight harvesting Corridor function Remote control					
KRBLT HBPIR15m-M	107	40	29	360	16	15
FEATURES:	ON/OFF Occupancy control Daylight threshold Staircase function (master and slave)			Grouping Scenes Astro timer (sunrise and sunset) KR app Bluetooth® control		
DALI KRBLT HBPIRD15m-M	107	40	29	360	16	15
FEATURES:	DALI2 output Occupancy control Daylight harvesting Corridor function Staircase function (master and slave)			Grouping Scenes Astro timer (sunrise and sunset) Circadian rhythm (Human centric lighting) KR app Bluetooth® control		

DETECTION DIAGRAM:

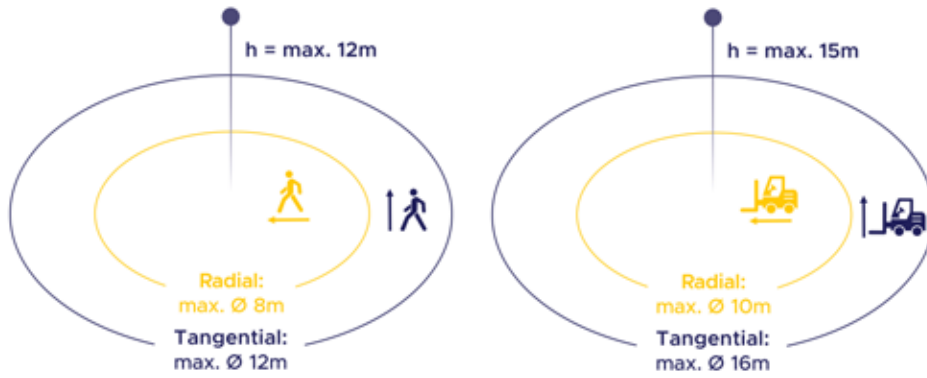

*Detection patterns are based upon 5km/h movement speed

A WAREHOUSE AISLE APPLICATION

Here is an example of the luminaires with HBPIR sensor behaviour in a warehouse application, when each fitting is switched on/off individually.

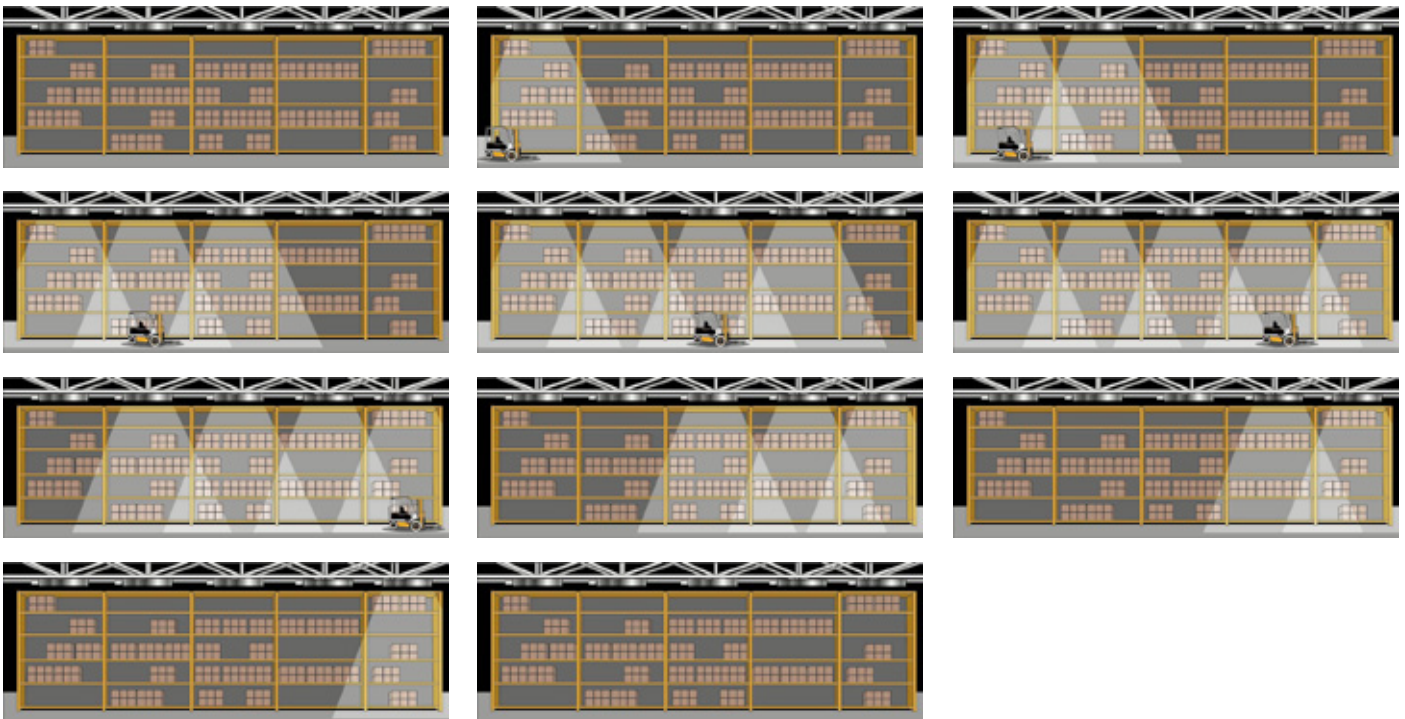

AVAILABLE ACCESSORIES:



Product: Remote control HRC-11
Description: The functionality of the HBPIR are controlled by a number of parameters which can be changed or programmed remotely with an infrared handset HRC-11

AVAILABLE WITH*:

Barat LED

Sumatra LED

Norte I LED

Norte L LED

Blade W LED

Blade Z LED



*For detailed information refer to luminaire family TDS

Zhaga socket HBPIR (Option)

Build-in PIR High-bay Sensor



DESCRIPTION:	Build-in PIR High-bay sensor Body: thermoplastic, light grey
FEATURES:	Occupancy control Corridor function Daylight harvesting Remote Control
GENERAL DATA:	Ingress protection: IP65 Operating temperature range, °C: according to product data sheet Control output: 0-10V Power consumption: 0.5W Dimensions: 55x55x44 mm Ambient Light: 10/30/50 lux or disable (selectable) Hold time: 10s/1min/5min/10min/15min/20min/30min/60min (selectable) Stand-by time: 10min/30min/60min/+∞ (selectable) Stand-by dimming level: 10/30/50% (selectable)
INSTALLATION:	Build into the luminaire. Zhaga18 socket
APPLICATION:	Industry, warehouse, cold store, hall

OPTION	LENGTH, mm	WIDTH, mm	HEIGHT, mm	DETECTION RANGE, °	MAX. DIAMETER, m	MAX. HEIGHT, m
DIM HBPIR12m	55	55	44	360	16	12

DETECTION DIAGRAM:

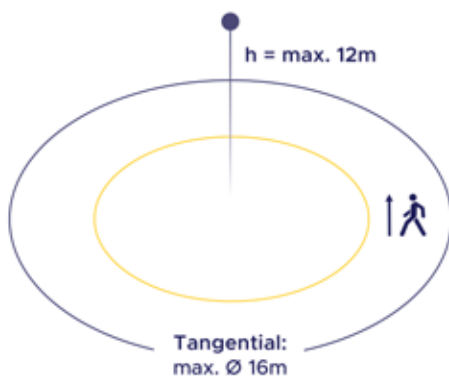

AVAILABLE ACCESSORIES:



Product: Remote Control RC (RC-100)
Description: The functionality of the HBPIR are controlled by a number of parameters which can be changed or programmed remotely with an infrared handset RC-100

AVAILABLE WITH*:

Disc A LED



*For detailed information refer to luminaire family TDS

Integrated HBPIR (Option)

Build-in PIR High-bay Sensor



- DESCRIPTION:** **Build-in PIR High-bay sensor**
Body: thermoplastic, white
Detection range: 360°
Detection diameter: 18m max (<24°C)
Installation height: 12m
-
- FEATURES:** **ON/OFF**
Daylight threshold
Up to -40°C
Two lenses: low-bay, high-bay and aisle mask
-
- GENERAL DATA:** **Mains voltage:** 220-240V, 50-60Hz
Protection class IEC: II
Ingress protection: IP65
Operating temperature range, °C: according to product data sheet
Control output: on/off
Dimensions: 98x51x50mm
Hold time: 30s/10min/20min/30min (selectable)
-
- INSTALLATION:** Build into the luminaire
-
- APPLICATION:** Industry, warehouse, cold store, hall, parking area, fuel station

OPTION	LENGTH, mm	WIDTH, mm	HEIGHT, mm	DETECTION RANGE, °	MAX. DIAMETER, m	MAX. HEIGHT, m
HBPIR-M	53	53	22	360	18	12

DETECTION DIAGRAM:

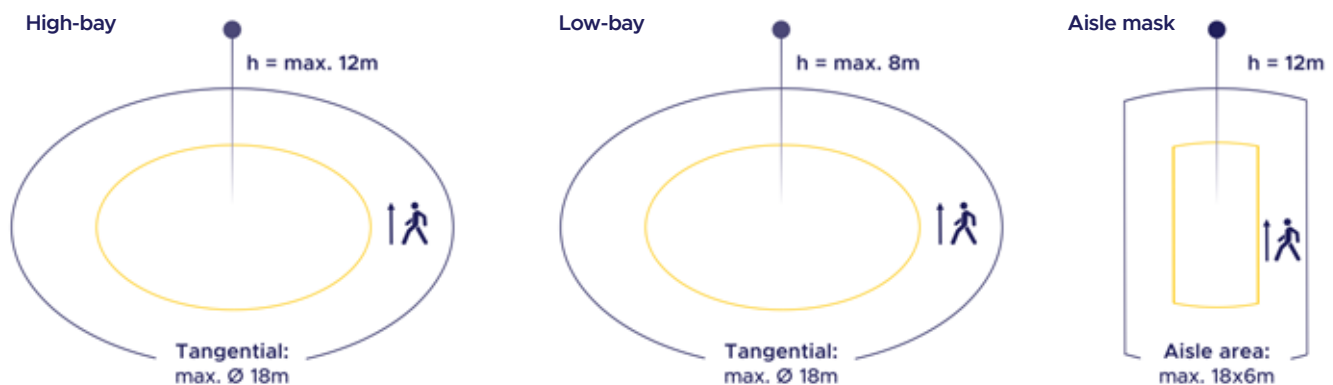

AVAILABLE WITH*:

Brubu N/E LED



*For detailed information refer to luminaire family TDS



Ceiling mounted PIR

High/Low-bay PIR Sensor



Optional

DESCRIPTION: Recessed or surface mounted High/Low-bay PIR sensor

Body: thermoplastic, white
Detection range: 360°
Detection diameter: 9-40m max. (ta 20°C)
Installation height: 2.5-12m

GENERAL DATA:

Mains voltage: 220-240V, 50-60Hz
Protection class IEC: II
Ingress protection: IP20 (IP54 optional)
Operating temperature range, °C: -20...+50
Switching load: 800W
Control output: on/off / DALI / DALI2 / Bluetooth® (optional)
DALI power supply: 80mA (up to 40 drivers)
Bluetooth® range: 10-30m
Power consumption: <1W
Ambient Light: 2/10/50/100/300/500lx or disable (selectable)
Hold time: 2s/30s/1min/5min/10min/15min/20min/30min (selectable)
DALI stand-by time: 0/10s/1min/5min/10min/30min/1h/+∞

INSTALLATION:

In ceilings with cut-out openings (Ø66-68). Screw terminal, 4x1x2.5mm²

ENVIRONMENT:

Indoor

APPLICATION:

Office, education, hotel, corridor, staircase, bathroom, industry, warehouse, public place

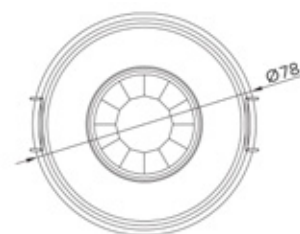

PRODUCT	LENGTH, mm	WIDTH, mm	HEIGHT, mm	DETECTION RANGE, °	MAX. DIAMETER, m	RECOMENDED HEIGHT, m
RPIR 360 D10/6 (HIR28/R)	78	78	78	360	10	2.5-6
RPIR 360 D18/6 (HIR28/W)	78	78	81	360	18	2.5-6
RPIR 360 D20/12 (HIR28/H)	78	78	81	360	20 (24 forklift)	2.5-12 (10-15 forklift)
RPIR 360 D30/12 (HIR28/RH)	78	78	83	360	30 (40 forklift)	2.5-12 (10-20 forklift)
FEATURES:	ON/OFF Occupancy control Absence detection		Daylight threshold Manual override Remote control			
RPIR 360 D10/6 DALI (HIR27/R)	78	78	78	360	10	2.5-6
RPIR 360 D18/6 DALI (HIR27/W)	78	78	81	360	18	2.5-6
RPIR 360 D20/12 DALI (HIR27/H)	78	78	81	360	20 (24 forklift)	2.5-12 (10-15 forklift)
RPIR 360 D30/12 DALI (HIR27/RH)	78	78	83	360	30 (40 forklift)	2.5-12 (10-20 forklift)
FEATURES:	DALI output Occupancy control Absence detection Daylight harvesting		Corridor function Synchronization via hardwire Manual override Remote control			

PRODUCT	LENGTH, mm	WIDTH, mm	HEIGHT, mm	DETECTION RANGE, °	MAX. DIAMETER, m	RECOMENDED HEIGHT, m
RPIR 360 D10/6 KRBLT (HBIR28/R)	78	78	78	360	10	2.5-6
RPIR 360 D18/12 KRBLT (HBIR28/W)	78	78	81	360	18	2.5-6
RPIR 360 D20/12 KRBLT (HBIR28/H)	78	78	81	360	20 (24 forklift)	2.5-12 (10-15 forklift)
RPIR 360 D30/12 KRBLT (HBIR28/RH)	78	78	83	360	30 (40 forklift)	2.5-12 (10-20 forklift)
FEATURES:	ON/OFF Occupancy control Absence detection Daylight threshold Staircase function (master and slave)			Grouping Scenes Astro timer (sunrise and sunset) Manual override KR app Bluetooth® control		
RPIR 360 D10/6 DALI KRBLT (HBIR29/R)	78	78	78	360	10	2.5-6
RPIR 360 D18/12 DALI KRBLT (HBIR29/W)	78	78	81	360	18	2.5-6
RPIR 360 D20/12 DALI KRBLT (HBIR29/H)	78	78	81	360	20 (24 forklift)	2.5-12 (10-15 forklift)
RPIR 360 D30/12 DALI KRBLT (HBIR29/RH)	78	78	83	360	30 (40 forklift)	2.5-12 (10-20 forklift)
FEATURES:	DALI output Occupancy control Absence detection DALI2 Daylight harvesting Corridor function Staircase function (master and slave)			Grouping Scenes Astro timer (sunrise and sunset) Circadian rhythm (Human centric lighting) Manual override KR app Bluetooth® control		

DETECTION DIAGRAM:

RPIR 360 D10/6 (HIR28/R) / RPIR 360 D10/6 DALI (HIR27/R) / RPIR 360 D10/6 KRBLT (HBIR28/R) / RPIR 360 D10/6 DALI KRBLT (HBIR29/R)

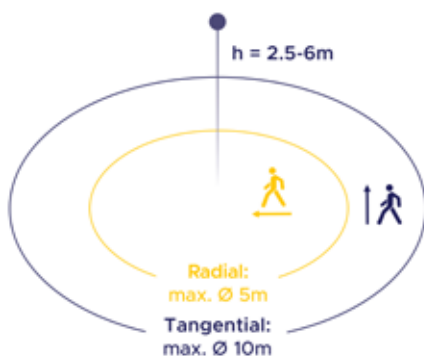

MOUNT HEIGHT, m	TANGENTIAL, m	RADIAL, m
2.5	∅ = 10	∅ = 5
3	∅ = 10	∅ = 5
4	∅ = 9	∅ = 5
5	∅ = 8	∅ = 5
6	∅ = 8	∅ = 5

RPIR 360 D18/6 (HIR28/W) / RPIR 360 D18/6 DALI (HIR27/W) / RPIR 360 D18/6 KRBLT (HBIR28/W) / RPIR 360 D18/6 DALI KRBLT (HBIR29/W)

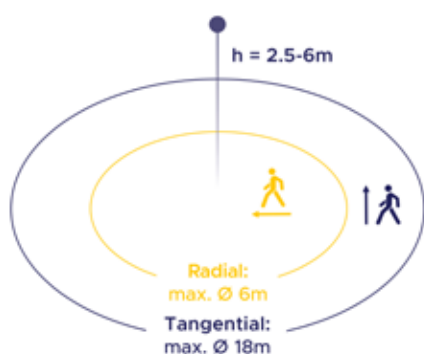

MOUNT HEIGHT, m	TANGENTIAL, m	RADIAL, m
2.5	∅ = 18	∅ = 6
3	∅ = 18	∅ = 6
4	∅ = 14	∅ = 6
5	∅ = 12	∅ = 6
6	∅ = 10	∅ = 4

DETECTION DIAGRAM:

RPIR 360 D20/12 (HIR28/H) / RPIR 360 D20/12 DALI (HIR27/H) / RPIR 360 D20/12 KRBLT (HBIR28/H) / RPIR 360 D20/12 DALI KRBLT (HBIR29/H)

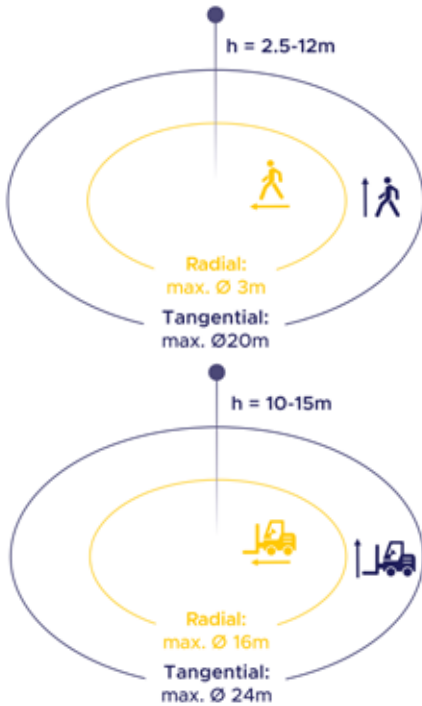

MOUNT HEIGHT, m	TANGENTIAL, m	RADIAL, m
2.5	Ø = 8	Ø = 3
6	Ø = 11.5	Ø = 3
8	Ø = 14	Ø = 3
10	Ø = 17	Ø = 3
11	Ø = 18.5	Ø = 3
12	Ø = 20	Ø = 3

MOUNT HEIGHT, m	TANGENTIAL, m	RADIAL, m
10	Ø = 22	Ø = 16
11	Ø = 24	Ø = 16
12	Ø = 24	Ø = 16
13	Ø = 24	Ø = 15
14	Ø = 24	Ø = 13
15	Ø = 24	Ø = 12

RPIR 360 D30/12 (HIR28/RH) / RPIR 360 D30/12 DALI (HIR27/RH) / RPIR 360 D30/12 KRBLT (HBIR28/RH) / RPIR 360 D30/12 DALI KRBLT (HBIR29/RH)

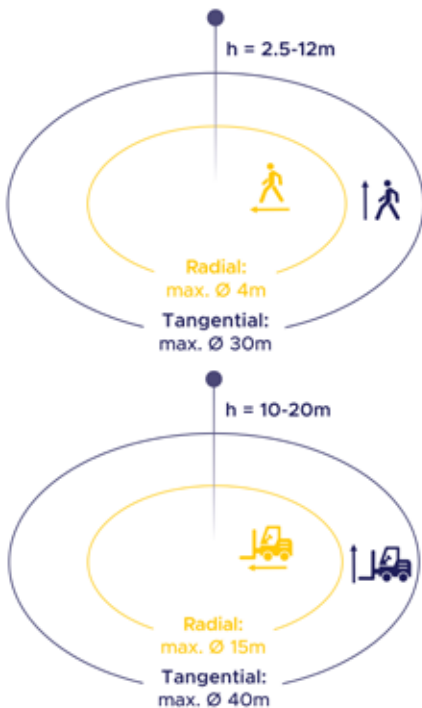

MOUNT HEIGHT, m	TANGENTIAL, m	RADIAL, m
2.5	Ø = 7	Ø = 3
6	Ø = 14	Ø = 3
8	Ø = 20	Ø = 3
10	Ø = 26	Ø = 4
11	Ø = 28	Ø = 4
12	Ø = 30	Ø = 4

MOUNT HEIGHT, m	TANGENTIAL, m	RADIAL, m
10	Ø = 21	Ø = 15
11	Ø = 29	Ø = 15
12	Ø = 34	Ø = 14
13	Ø = 35	Ø = 14
14	Ø = 37	Ø = 12
15	Ø = 40	Ø = 12
20	Ø = 30	Ø = 12

WIRING DIAGRAM:

RPIR 360 D10/6 (HIR28/R) / PIR 360 D18/6 (HIR28/W) / RPIR 360 D20/12 (HIR28/H) / RPIR 360 D30/12 (HIR28/RH)

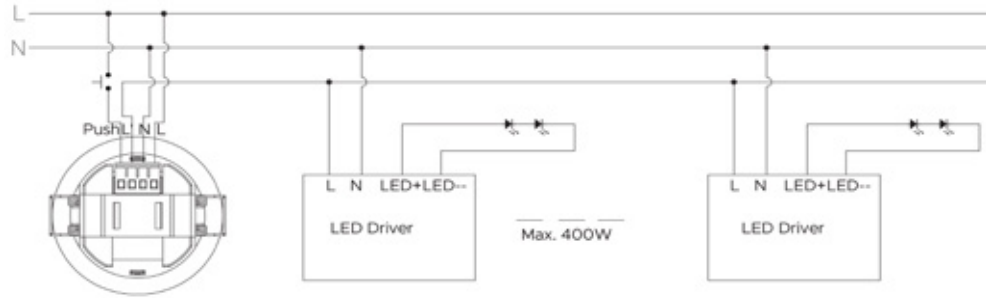

RPIR 360 D10/6 DALI (HIR27/R) / RPIR 360 D18/6 DALI (HIR27/W) / RPIR 360 D20/12 DALI (HIR27/H) / RPIR 360 D30/12 DALI (HIR27/RH)

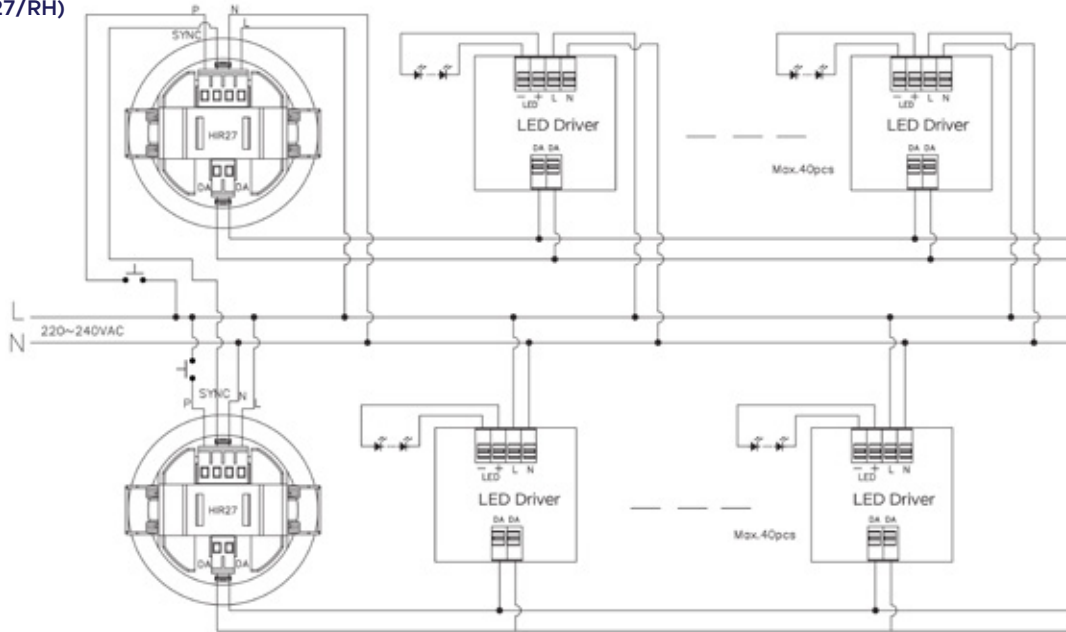

RPIR 360 D10/6 DALI KRBLT (HBIR29/R) / RPIR 360 D18/12 DALI KRBLT (HBIR29/W) / RPIR 360 D20/12 DALI KRBLT (HBIR29/H) / RPIR 360 D30/12 DALI KRBLT (HBIR29/RH)

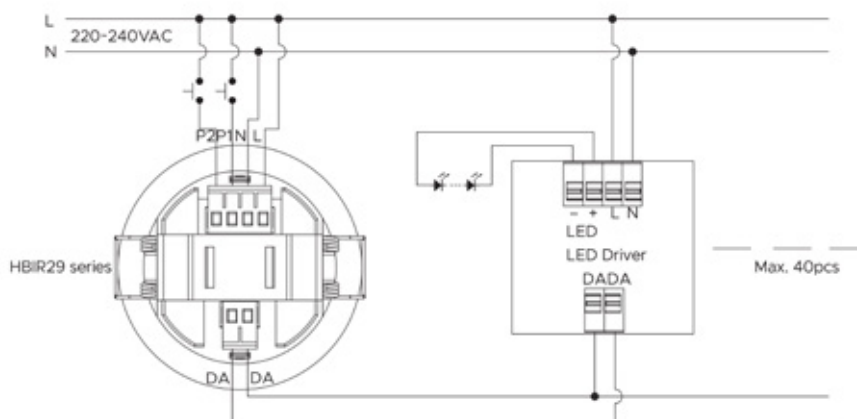

AVAILABLE ACCESSORIES:



Product: Remote control HRC-11
Description: The functionality of the HBPIR is controlled by a number of parameters which can be changed or programmed remote with an infrared handset HRC-11



Product: Surface MTG BOX HIR (HA09)
Description: Surface mounting box for HIR28 sensor, white steel, D94x93mm

Product: Surface MTG BOX HIR IP54 (HA09/IP54)

Description: Surface mounting box for HIR28 sensor, white steel, D94x93mm, IP54



Product: HIR 28 Aisle mask
Description: Blind Option 1 - Aisle detection



Product: HIR28 180 mask
Description: Blind Option 2 - 180° Detection

Ceiling mounted wireless PIR

Low-bay PIR Sensor with Bluetooth® controls



DESCRIPTION:	Recessed/surface mounted Bluetooth® DALI PIR Sensor Body: thermoplastic, white
FEATURES:	Occupancy control Absence detection Daylight harvesting Grouping Scenes BLT app control
GENERAL DATA:	Mains voltage: 220-240V, 50-60Hz Protection class IEC: II Ingress protection: IP20 Operating temperature range, °C: 0...+50 Power consumption: <0.5W Movement speed: 0.5-1.5m/s
INSTALLATION:	In ceilings with cut-out openings (Ø68). Push-in terminal, 2x1x2.5mm ²
ENVIRONMENT:	Indoor
APPLICATION:	Office, education, hotel, corridor, public place

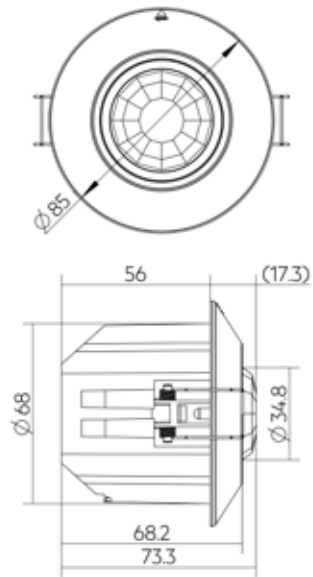

PRODUCT	CONTROL OUTPUT	LENGTH, mm	WIDTH, mm	HEIGHT, mm	DETECTION RANGE, °	MAX. DIAMETER, m	MAX. HEIGHT, m
RPIR 360 D8/4 BLT (basicDIM Wireless Sensor 5DP 38rc)	Bluetooth®	85	85	73,3	360	8	4

DETECTION DIAGRAM:

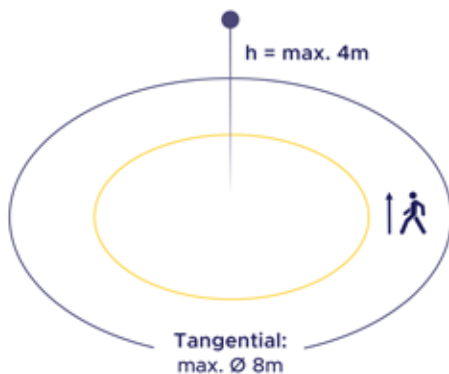

MOUNT HEIGHT, m	TANGENTIAL, m
2	Ø = 5.3
2.5	Ø = 6.6
3	Ø = 8.0
3.5	Ø = 9.3
4	Ø = 10.6

WIRING DIAGRAM:

RPIR 360 D8/4 BLT

220-240V
50/60 Hz

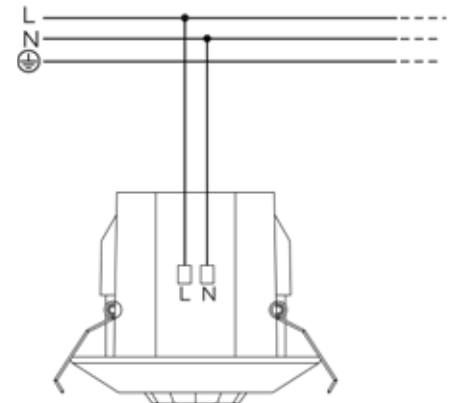

AVAILABLE ACCESSORIES:



Product: Surface MTG BOX BLT (Sensor housing bDW rs)
Description: Surface mounting box for RPIR 360 D88/4 BLT sensor, white steel, D95x65mm

Integrated PIR (Option)

Build-in dimmable PIR Low-bay Sensor



DESCRIPTION:	Build-in DALI2 / Bluetooth® PIR Sensor Body: thermoplastic, white
GENERAL DATA:	Mains voltage: 220-240V, 50-60Hz Protection class IEC: II Ingress protection: IP20 Operating temperature range, °C: according to product data sheet Required DALI current: 30mA Movement speed: 0.5-1.5m/s
INSTALLATION:	Build into the luminaire
ENVIRONMENT:	Indoor
APPLICATION:	Office, education, hotel, corridor, staircase, public place, Industry, warehouse, hall

OPTION	CONTROL OUTPUT	LENGTH, mm	WIDTH, mm	HEIGHT, mm	DETECTION RANGE, °	MAX. DIAMETER, m	MAX. HEIGHT, m
DALI PIR	DALI2	26	26	32	360	12	3
FEATURES:	DALI2 output Occupancy control Absence detection Daylight threshold		Daylight harvesting Corridor function IP20				
KRBLT DALI PIR	DALI	26	26	32	360	12	3
FEATURES:	DALI output Occupancy control Absence detection DALI2 Daylight harvesting		Corridor function Staircase function (master and slave) Grouping Scenes		Astro timer (sunrise and sunset) Circadian rhythm (Human centric lighting) KR app Bluetooth® control IP20		

DETECTION DIAGRAM:

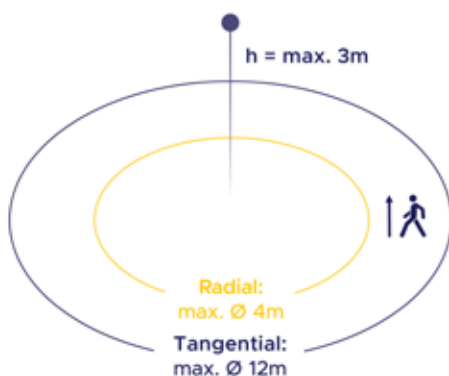

MOUNT HEIGHT, m	TANGENTIAL, m	RADIAL, m
3	Ø = 12	Ø = 4

AVAILABLE WITH*:

Eridanus R/S LED

Calima R/S LED

Etesian U LED

Calima U LED

Serpens LED

Decor LED



*For detailed information refer to luminaire family TDS

and others...

Integrated PIR

Build-in dimmable PIR Mid-bay Sensor

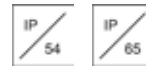

DESCRIPTION:	Build-in DALI2 / Bluetooth® PIR Sensor Body: thermoplastic, white
GENERAL DATA:	Mains voltage: 220-240V, 50-60Hz Protection class IEC: II Ingress protection: IP54 KRBLT DALI HBPIR; IP65 DALI HBPIR option Operating temperature range, °C: according to product data sheet Required DALI current: 30mA Movement speed: 0.5-1.5m/s
INSTALLATION:	Build into the luminaire
ENVIRONMENT:	Indoor
APPLICATION:	Office, education, hotel, corridor, staircase, public place, Industry, warehouse, hall

OPTION	CONTROL OUTPUT	LENGTH, mm	WIDTH, mm	HEIGHT, mm	DETECTION RANGE, °	MAX. DIAMETER, m	MAX. HEIGHT, m
DALI HBPIR	DALI2	37	37	44	360	12	8
FEATURES:	DALI2 output Occupancy control Absence detection		Daylight harvesting Corridor function IP54				
KRBLT DALI HBPIR	DALI	37	37	44	360	12	8
FEATURES:	DALI output Occupancy control Absence detection Daylight harvesting		Corridor function Staircase function (master and slave) Grouping Scenes		Astro timer (sunrise and sunset) Circadian rhythm (Human centric lighting) KR app Bluetooth® control IP65		

DETECTION DIAGRAM:

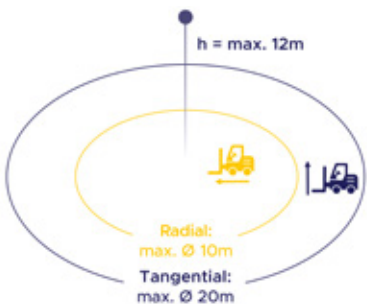
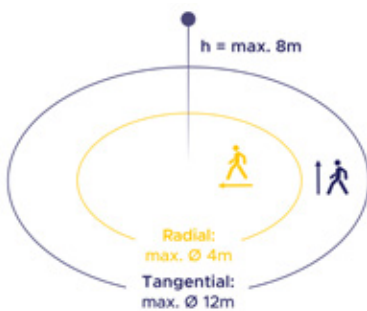

MOUNT HEIGHT, m	TANGENTIAL, m	RADIAL, m
3	Ø = 7	Ø = 3
4	Ø = 8	Ø = 3
5	Ø = 8	Ø = 3
6	Ø = 9	Ø = 4
7	Ø = 11	Ø = 4
8	Ø = 12	Ø = 4

MOUNT HEIGHT, m	TANGENTIAL, m	RADIAL, m
8	Ø = 16	Ø = 8
9	Ø = 17	Ø = 8
10	Ø = 18	Ø = 9
11	Ø = 20	Ø = 10
12	Ø = 20	Ø = 10

AVAILABLE WITH*:

Norte I LED

Norte L LED



*For detailed information refer to luminaire family TDS

MW SENSORS

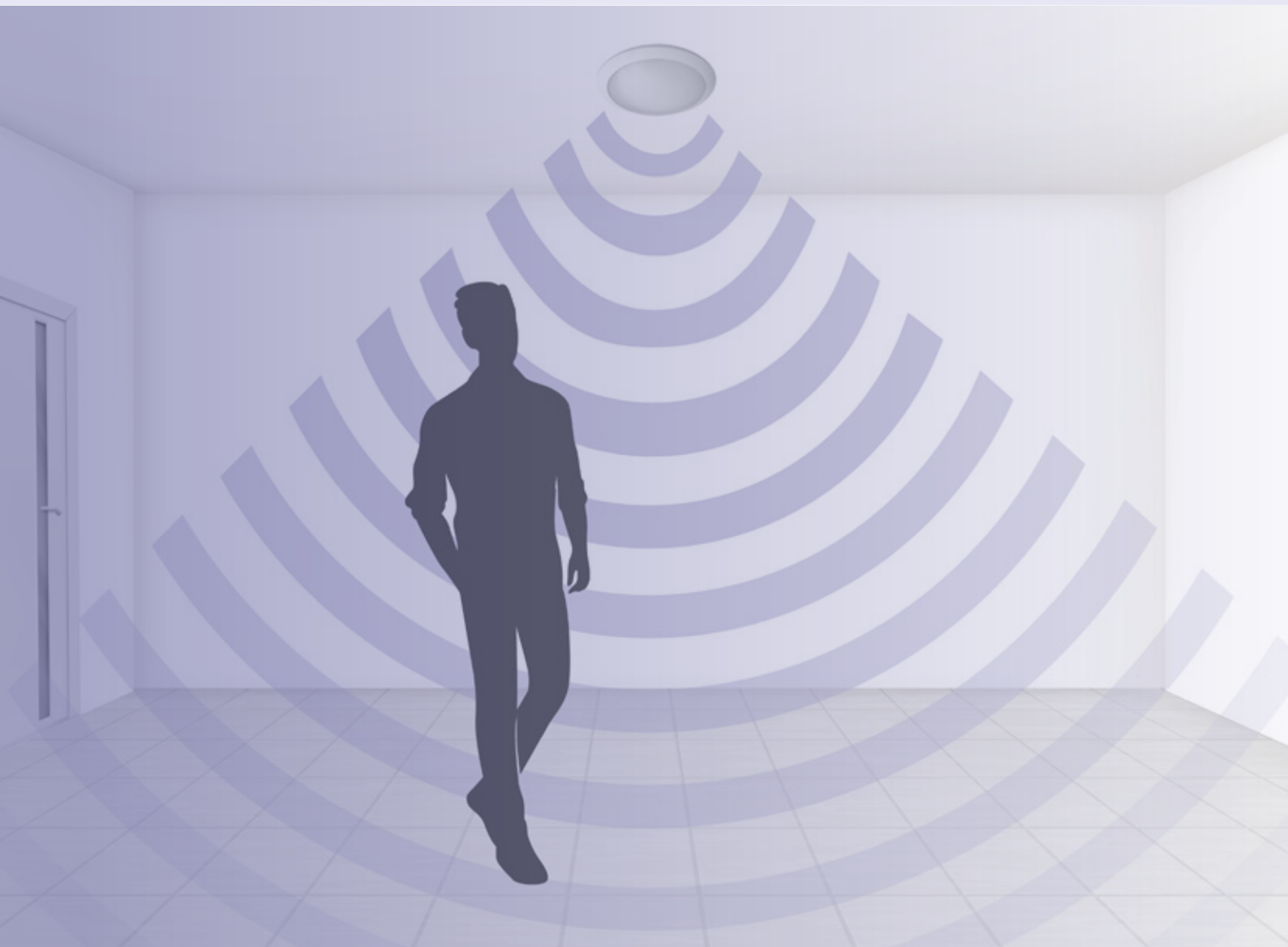

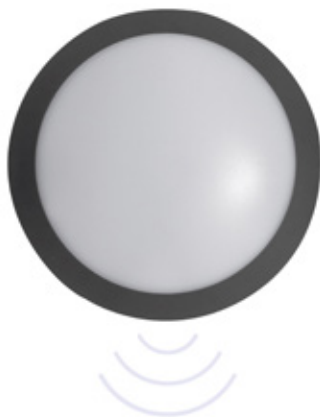

MW (Option)

Build-in MW Sensor



DESCRIPTION: **Buil-in MW sensor**
Body: thermoplastic, white
Detection range: 360°
Detection diameter: up to 12m (ta 20°C)
Installation height: 2.2-6.0m

FEATURES: **Occupancy control**
Daylight threshold
Tri-level control (optional DALI)
Remote Control (optional DALI)

GENERAL DATA: **Mains voltage:** 220-240V, 50-60Hz
Protection class IEC: II
Ingress protection: IP20
Operating temperature range, °C: according to product data sheet
Switching load: 800W
Control output: ON/OFF/ DALI / Bluetooth® (optional)
DALI power supply: 40mA (up to 20 drivers)
Bluetooth® range: 10-30m
Power consumption: <0.5W
Ambient Light: 2/10/50lx or disable (selectable)
Hold time: 5s/90s/5min/15min (DALI 30s/1min/5min/10min/15min/20min/30min) (selectable)
DALI stand-by time: 0/10s/1min/5min/10min/30min/1h/+∞
Movement speed: 0.5-1.5m/s

INSTALLATION: Build into the luminaire

APPLICATION: Corridor, staircase, bathroom, public place

*For detailed information refer to luminaire family TDS

OPTION	LENGTH, mm	WIDTH, mm	HEIGHT, mm	DETECTION RANGE, °	MAX. DIAMETER, m	MAX. HEIGHT, m
MW	-	-	-	360	10	6
FEATURES:	ON/OFF Occupancy control Daylight threshold					
DALI MW	-	-	-	360	12	6
FEATURES:	DALI output Occupancy control Absence detection Daylight harvesting		Corridor function Synchronization via hardwire Manual override Remote control			
KRBLT MW	-	-	-	360	10	6
FEATURES:	ON/OFF Occupancy control Daylight threshold Staircase function (master and slave)		Grouping Scenes Astro timer (sunrise and sunset) KR app Bluetooth® control			
DALI KRBLT MW	-	-	-	360	10	6
FEATURES:	DALI output Occupancy control Daylight harvesting Corridor function Staircase function (master and slave)		Grouping Scenes Astro timer (sunrise and sunset) KR app Bluetooth® control			

DETECTION DIAGRAM:

MW

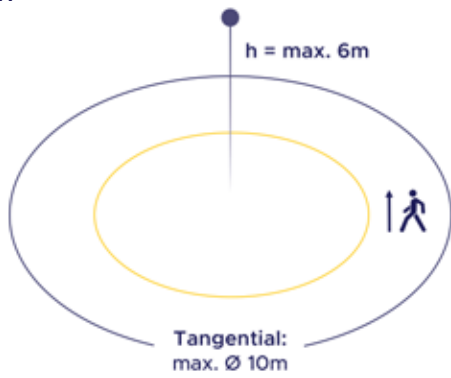

MOUNT HEIGHT, m	HIGH SENSITIVITY AREA TANGENTIAL, m	LOW SENSITIVITY AREA TANGENTIAL, m
1	Ø = 5	Ø = 6
2	Ø = 7	Ø = 8
3	Ø = 8	Ø = 9
4	Ø = 7	Ø = 10
5	Ø = 4	Ø = 8
6	Ø = 1	Ø = 5

DALI MW

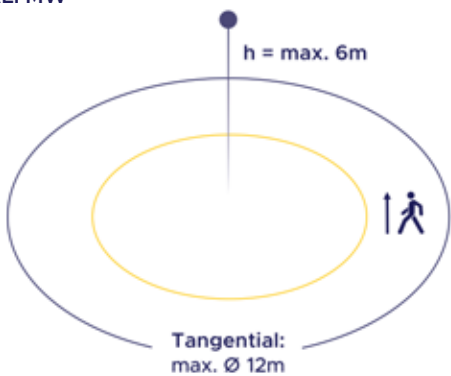

MOUNT HEIGHT, m	HIGH SENSITIVITY AREA TANGENTIAL, m
1	Ø = 8
2	Ø = 10
3	Ø = 11
4	Ø = 12
5	Ø = 11
6	Ø = 10

AVAILABLE WITH*:

Pavo P LED



Indus P LED



Heze P LED



Storm P LED



Carina P LED



Carina LED



Doctor P LED



Sumatra LED



*For detailed information refer to luminaire family TDS

and others...

eCOR MW (Option)

Build-in MW Sensor and corridor function



DESCRIPTION: Built-in MW sensor and driver with adaptive corridor function

Body: thermoplastic, white
Detection range: 360°
Detection diameter: 8m max. (ta 20°)
Installation height: 6m max. (ta 20°)

FEATURES: Tri-level control
Absence detection
Daylight threshold
Daylight harvest

GENERAL DATA: Mains voltage: 220-240V, 50-60Hz
Protection class IEC: II
Ingress protection: IP20
Operating temperature range, °C: according to product data sheet
Control output: 0-10V
Power consumption: <1W
Detection range: 100/50% (selectable)
Ambient Light: 30lx or disable (selectable)
Hold time: 90s/5min/10min (selectable)
Stand-by time: 10min/+∞ (selectable)
Stand-by dimming level: 10/30% (selectable)
Movement speed: 0.5-1.5m/s

INSTALLATION: Build into the luminaire

APPLICATION: Corridor, staircase, bathroom, public place

OPTION	LENGTH, mm	WIDTH, mm	HEIGHT, mm	DETECTION RANGE, °	MAX. DIAMETER, m	MAX. HEIGHT, m
eCOR MW	-	-	-	360	8	6

DETECTION DIAGRAM:

CEILING MOUNTING

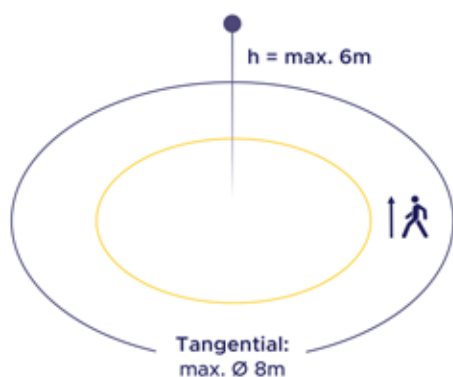

MOUNT HEIGHT, m	HIGH SENSITIVITY AREA TANGENTIAL, m	LOW SENSITIVITY AREA TANGENTIAL, m
1	Ø = 6	Ø = 3
2	Ø = 8	Ø = 5
3	Ø = 8	Ø = 5
4	Ø = 7	Ø = 3
5	Ø = 6	Ø = 3
6	Ø = 5	Ø = 2

AVAILABLE WITH*:

Indus P LED

Heze P LED

Pollux P LED

Dorado P LED

Barat LED

Sumatra LED



*For detailed information refer to luminaire family TDS

and others...

Integrated MW (Option)

Build-in MW Sensor



DESCRIPTION:	Built-in MW sensor Body: thermoplastic, white Detection range: 360° Detection diameter: 12m max. (ta 20°) Installation height: 6m max. (ta 20°)
GENERAL DATA:	Mains voltage: 220-240V, 50-60Hz Protection class IEC: II Ingress protection: IP20 Operating temperature range, °C: according to product data sheet Switching load: 800W Control output: on/off Power consumption: <0.5W Detection range: 100/75/50/25/10% (selectable) Ambient Light: 5/10/30/50lx or disable (selectable) Hold time: 10s/30s/90s/6min/20min/30min (selectable) Movement speed: 0.5-1.5m/s
INSTALLATION:	Build into the luminaire
APPLICATION:	Corridor, staircase, public place

OPTION	LENGTH, mm	WIDTH, mm	HEIGHT, mm	DETECTION RANGE, °	MAX. DIAMETER, m	MAX. HEIGHT, m
MW	-	-	-	360	12	6
FEATURES:	ON/OFF Occupancy control Daylight threshold					
DIM MW	-	-	-	360	12	6
FEATURES:	1-10V output Occupancy control Absence detection Daylight harvesting		Corridor function Manual override Remote control			

DETECTION DIAGRAM:

CEILING MOUNTING

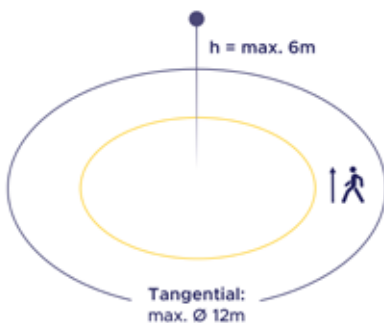

MOUNT HEIGHT, m	HIGH SENSITIVITY AREA TANGENTIAL, m
1	Ø = 8
2	Ø = 10
3	Ø = 11
4	Ø = 12
5	Ø = 11
6	Ø = 10

WALL MOUNTING

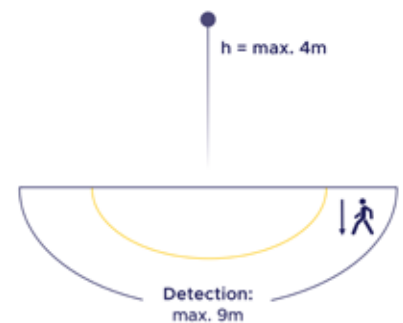

AVAILABLE WITH*:

Decor P LED

Decor O LED

Serpens P LED

Serpens O LED

Bali S LED

Bali U LED



*For detailed information refer to luminaire family TDS

and others...

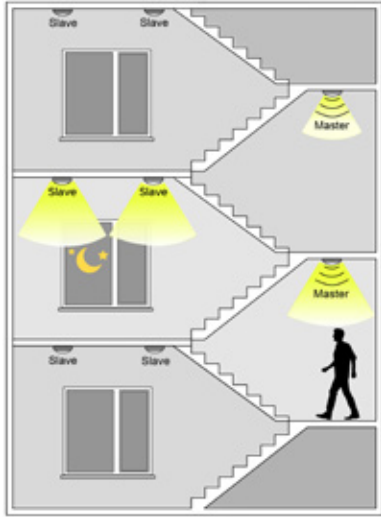

MWRF (Option)

Build-in Wireless MW Sensor



DESCRIPTION: **Buil-in RF Wireless MW sensor**
Body: thermoplastic, white
Detection range: 360°
Detection diameter: 12m max. (ta 20°)
Installation height: 6m max. (ta 20°)
RF channels: 16
RF transmitting distance: 30m

FEATURES: **Corridor function**
Daylight threshold
Grouping luminaires

GENERAL DATA: **Mains voltage:** 220-240V, 50-60Hz
Protection class IEC: II
Ingress protection: IP20
Operating temperature range, °C: according to product data sheet
Control output: 0-10V, on/off
Power consumption: <0.5W
Detection range: 100/75/50/10% (selectable)
Ambient Light: 2/10/50lx/disable (selectable)
Hold time: 5s/30s/1min/5min/10min/20min/30min (selectable)
Stand-by time: 0s/10s/1min/5min/10min/30min/1h/+∞ (selectable)
Stand-by dimming level: 10/20/30/50% (selectable)
Transmission distance: 30m inside building (up to 100m in open area)
Movement speed: 0.5-1.5m/s

INSTALLATION: Build into the luminaire

APPLICATION: Office, education, hotel, corridor, staircase, bathroom, public place, parking area

OPTION	DESCRIPTION	DETECTION RANGE, °	MAX. DIAMETER, m	MAX. HEIGHT, m
MWRFM	Built-in microwave motion sensor with integrated wireless transceiver. Sensor can serve as both master and slave. Functions: staircase, corridor.	360	12	6
MWRFS	Built-in wireless receiver for receiving master luminaire control signals. Functions: staircase, corridor.	360	-	-
MWRFMD	Built-in microwave motion sensor with integrated wireless transceiver. Sensor can serve as both master and slave. Functions: staircase, corridor, dimming control.	360	12	6
MWRFSD	Built-in wireless receiver for receiving master luminaire control signals. Functions: staircase, corridor, dimming control.	360	-	-

MWRFM



MWRFS



MWRFM has TX and RX channels and MWRFS has one RX channel. The TX channel is used for transmitting RF signal and RX channel is used for receiving RF signal. Use a small screwdriver to rotate the rotary switches and keep them pointed to same channel, groups will be created automatically

CORRIDOR APPLICATION:

All sensors set the same channel. See below picture, there are several exits/entrances to the corridor. Any Master sensor is triggered, all luminaires in the corridor will light up.

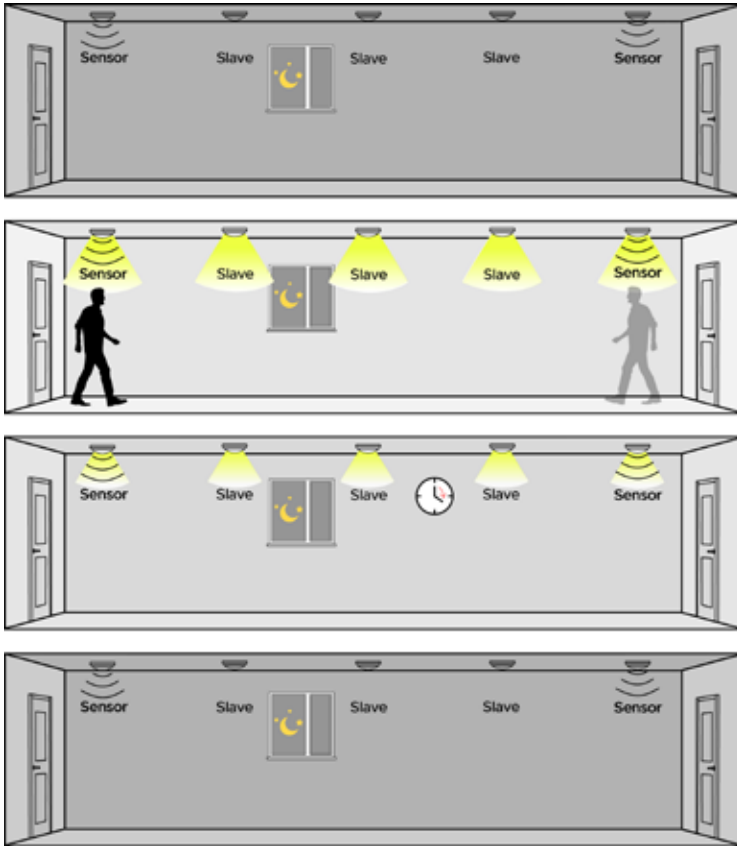

1. If no motion is detected, all luminaires will be switched off.

2. If any movement is detected from any direction, all luminaires will be synchronously switched on.

3. If no motion is detected in the detection zone, all luminaires will be synchronously dimmed to a low light level after hold time.

4. After stand-by period, the luminaires will be switched off if no movement is detected in the detection zone.

STAIRCASE APPLICATION:

Once any Master motion is detected, the motion signal will be transmitted to other grouped sensors through RF transceiver. See the picture below, when the person walks to one of the floors, the luminaires in adjacent floors will switch on at a pre-set low light level synchronously.

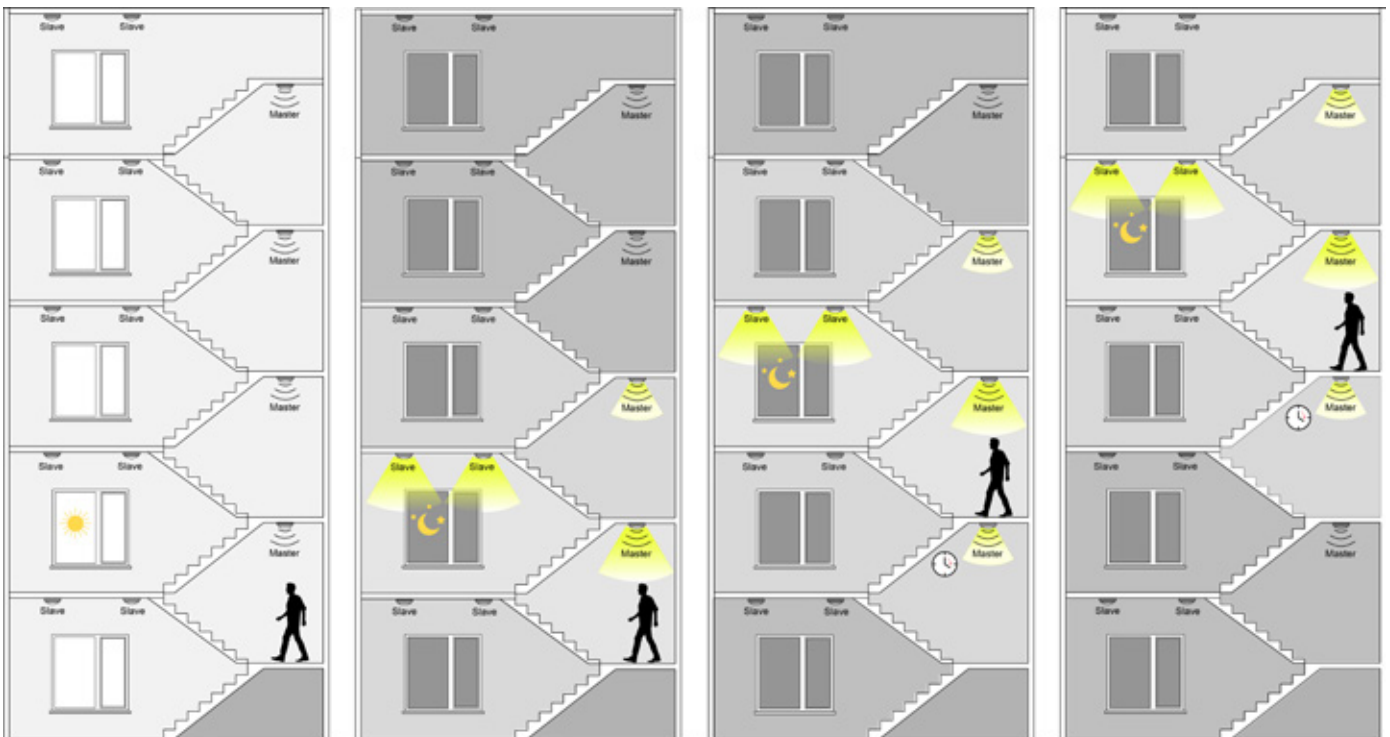

1. With sufficient ambient light, all luminaires switch off even if there is motion.

2. With insufficient ambient light and the person walks to the 2nd floor, all the 2nd floor luminaires switch on at 100%, and the 1st and 3rd floor luminaires switch on at a present light level.

3. The person walks to the 3rd floor, all the 3rd floor luminaires light up to 100%, and the 4th floor luminaire switches on at a present light level. The 2nd floor luminaire dim to a low light level after hold time.

4. The person walks to the 4th floor, all the 4th luminaires light up to 100%, and 5th floor luminaire switches on to a low light level. The 3rd luminaire dims to a low light level after hold time. The second luminaire switches off after a standby period.

DETECTION DIAGRAM:

CEILING MOUNTING

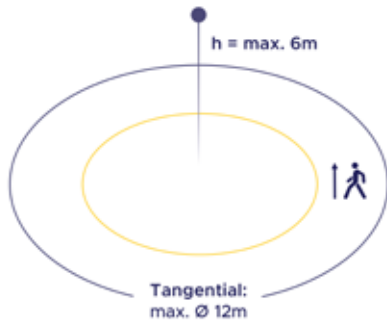

MOUNT HEIGHT, m	HIGH SENSITIVITY AREA TANGENTIAL, m
1	Ø = 8
2	Ø = 10
3	Ø = 11
4	Ø = 12
5	Ø = 11
6	Ø = 10

WALL MOUNTING

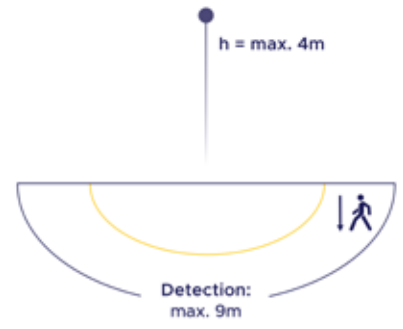

AVAILABLE WITH*:

Indus P LED



Heze P LED



Pollux P LED



Dorado P LED



*For detailed information refer to luminaire family TDS

and others...

KR WIRELESS SYSTEM



KR WIRELESS SYSTEM COMPONENTS

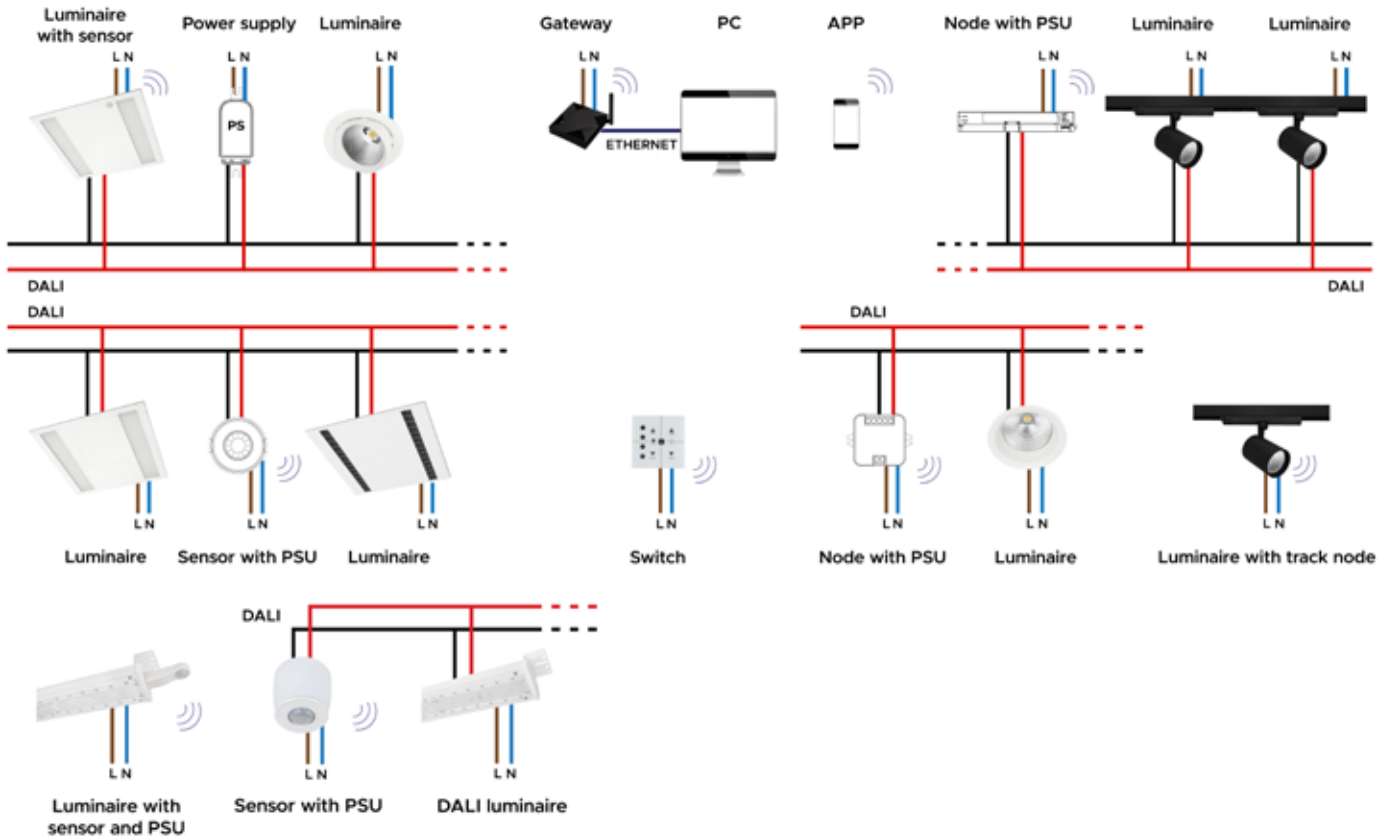

KR is an advanced lighting control solution based on Bluetooth® 5.0 SIG Mesh technology. Our KR Bluetooth® eco-system consists of sensors, LED luminaires, emergency luminaires, transceiver nodes, gateway, touch panel and other components. Koolmesh technology provides a mesh network where all the intelligence of the system is replicated in every node. With a dedicated phone/tablet app and web platform, KR Bluetooth® solution serves for small-scale and large-scale installation in commercial and industrial applications. User friendly wireless mesh networking interface allows significant savings by minimizing the labour costs on both, new and retrofit upgrade projects whilst simplifying the challenging requirements on site.

FEATURES

- Quick & advanced setup mode
- Staircase function for quick master & slave setup
- Web app/platform for dedicated project management
- Remote control via gateway support
- Deep environment learning
- Grouping luminaires via mesh network
- Scenes
- Daylight harvesting (24h)
- Tri-level control
- Daylight harvest
- Circadian rhythm (Human centric lighting)
- Push switch configuration
- Detailed motion sensor settings
- Schedule
- Astro timer (sunrise and sunset)
- Power-on status (memory against power loss)
- Offline commissioning
- Bulk commissioning (copy and paste settings)
- Different permission levels via authority management
- Network sharing via QR code or key code
- Compatible with EnOcean BLE switches
- Internet-of-Things (IoT) featured
- Device firmware update over-the-air (OTA)



KR Gateway

Bluetooth® Gateway



DESCRIPTION:	Bluetooth® gateway Body: thermoplastic, black
GENERAL DATA:	Mains voltage: 220-240V, 50-60Hz Protection class IEC: II Ingress protection: IP20 Operating temperature range, °C: -35...+70 Lan: Rj45 Ethernet port (100m) Dual WIFI: 2.4G+5G(AC2x2)
APPLICATION:	Office, education, hotel, public place, industry, warehouse, hall

PRODUCT	LENGTH, mm	WIDTH, mm	HEIGHT, mm	BLUETOOTH® RANGE, m
KRBLT gateway (HBGW01)	105	105	25	10



KR Switch

Wall-Mounted Bluetooth® Touch Panel



DESCRIPTION:	Wall-Mounted Bluetooth® Touch Panel Body: thermoplastic, white
GENERAL DATA:	Mains voltage: 220-240V, 50-60Hz Protection class IEC: II Ingress protection: IP20 Operating temperature range, °C: 0...+50 Power consumption: 1.5W Movement speed: 0.5-1.5m/s
INSTALLATION:	In the switch box. Screw terminal, 2x1x2.5mm ²
APPLICATION:	Office, education, hotel, public place, industry, warehouse, hall

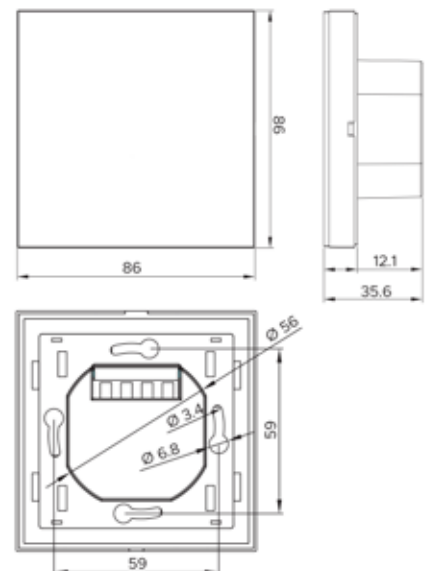

FEATURES

- Grouping luminaires via mesh network
- Scenes
- Manual adjustment: on/off, dim and color tuning
- Manual/Auto display screen brightness adjustment
- Compatible with EnOcean BLE switches
- Schedule to run scenes based on time and date
- Astro timer (sunrise and sunset)
- Device firmware update over-the-air (OTA)
- Off-line commissioning
- Different permission levels via authority management
- Network sharing via QR code or keycode
- Remote control via gateway support KR gateway

- Keep real time for up to 7-8 weeks against power failure
- Touch screen with vibration/beeper/LED indication
- Designed for electrical box/junction box

PRODUCT	LENGTH, mm	WIDTH, mm	HEIGHT, mm	BLUETOOTH® RANGE, m
KRBLT switch (HBPO2)	86	86	35.6	10-30



KR Node

Built-in Bluetooth® Transceiver Node



DESCRIPTION: **Built-in Bluetooth® transceiver node**
Body: thermoplastic, white

GENERAL DATA: **Mains voltage:** 220-240V, 50-60Hz
Protection class IEC: II
Ingress protection: IP20
Operating temperature range, °C: according to product data sheet
Switching load: 800W
DALI power supply: 100mA (up to 40 drivers)
Power consumption: <0.5W

INSTALLATION: Build into the luminaire or junction box. Screw terminal, 5x1x2.5mm²

APPLICATION: Office, education, hotel, public place, industry, warehouse, hall

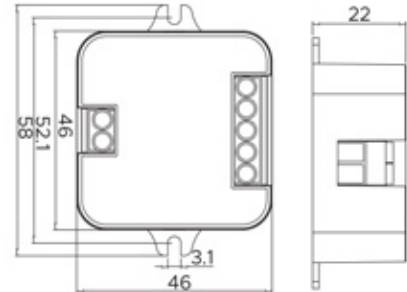

FEATURES

- Grouping luminaires via mesh network
- Scenes
- Push switch configuration
- Schedule to run scenes based on time and date
- Astro timer (sunrise and sunset)
- Device firmware update over-the-air (OTA)
- Power-on status (memory against power loss)
- Off-line commissioning
- Different permission levels via authority management
- Network sharing via QR code or key code
- Remote control via gateway support KR gateway
- Compatible with EnOcean BLE switches
- 2 Push inputs for flexible manual control

PRODUCT	LENGTH, mm	WIDTH, mm	HEIGHT, mm	CONTROL OUTPUT	BLUETOOTH® RANGE, m
KRBLT node (HBTD820S/F)	58	46	22	on/off	10-30
KRBLT DALI node (HBTD8200D/F)	58	46	22	DALI	10-30



KR DALI Track Node

Track Mounted Bluetooth® Transceiver Node



DESCRIPTION: **Track mounted Bluetooth® Control Unit**
Body: polycarbonate, black

FEATURES: **Grouping**
Scenes
Astro timer (sunrise and sunset)
Schedule to run scenes based on time and date
KR app Bluetooth® control

GENERAL DATA: **Mains voltage:** 220-240V, 50-60Hz
Protection class IEC: II
Ingress protection: IP20
Operating temperature range, °C: -10..+35
DALI power supply: 80mA (up to 40 drivers)
Power consumption: <0.5W

INSTALLATION: In 3-phase track. Track adaptor (3-phase + control) with phase selector

APPLICATION: Office, hotel, corridor, retail, showroom, museum, exhibition

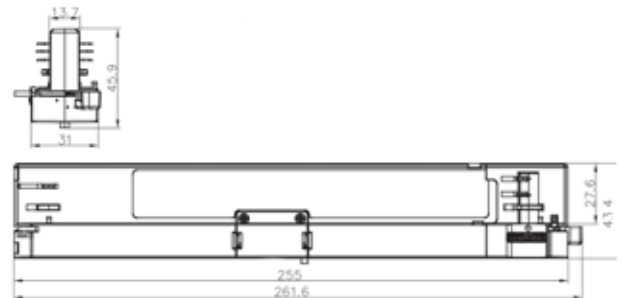

PRODUCT	LENGTH, mm	WIDTH, mm	HEIGHT, mm	CONTROL OUTPUT	BLUETOOTH® RANGE, m
KRBLT DALI track node (HBTD54)	262	31	46	DALI	10-30

KR system TRACK (Option)

Track mounted Bluetooth® LED Spotlight



- DESCRIPTION:** Track mounted Bluetooth® LED Spotlight
Body: thermoplastic, black
-
- FEATURES:** Grouping luminaires via mesh network
Scenes
Astro timer (sunrise and sunset)
Schedule to run scenes based on time and date
KR app Bluetooth® control
-
- GENERAL DATA:** Mains voltage: 220-240V, 50-60Hz
Protection class IEC: II
Ingress protection: IP20
Operating temperature range, °C: according to product data sheet
-
- INSTALLATION:** In 3-phase track. Track adaptor (3-phase + control) with phase selector
-
- APPLICATION:** Office, hotel, corridor, retail, showroom, museum, exhibition

OPTION	LENGTH, mm	WIDTH, mm	HEIGHT, mm	CONTROL OUTPUT	BLUETOOTH® RANGE, m
KRBLT	-	-	-	-	10-30



KR system APP

User Interface

The KR app works as one of the user interfaces in KR wireless lighting control solution: as the commissioning tool and as a remote gateway which allows commissioning agents, contractors, installers, and facility managers to configure, control and manage lighting infrastructures based on qualified Bluetooth® mesh.

The KR app works with iOS as well as Android which are free to download from Apple App Store and Google Play

EAIR WIRELESS SYSTEM

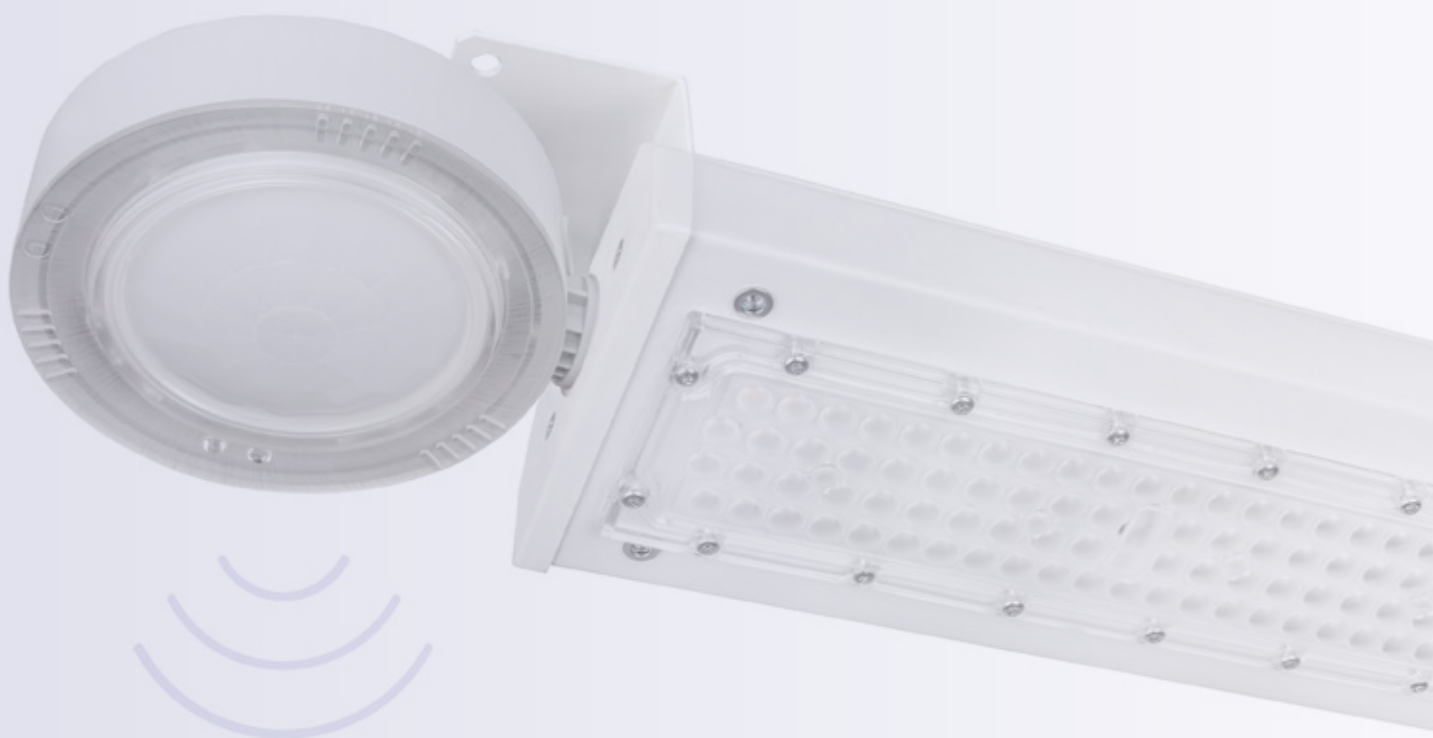
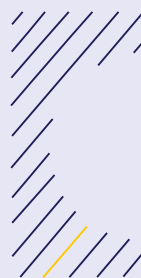

EAIR WIRELESS SYSTEM

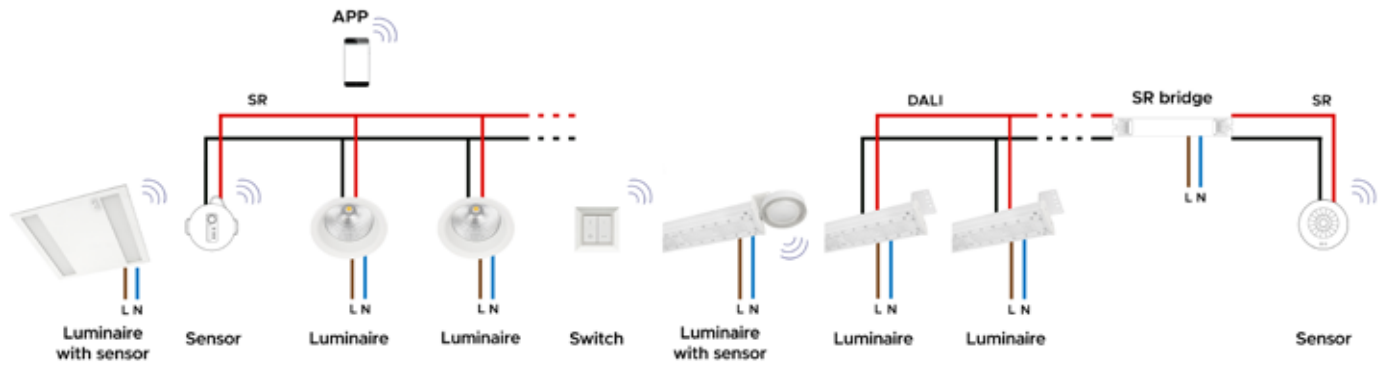

The EAIR system enables you to create connected lighting installations that are simple and scalable, with no hassle during installation and commissioning. The reliable wireless platform and products offer the opportunity to tap into all the benefits of connected lighting, like automation, human-centric lighting or energy savings. What's more, EAIR system combined with LED lighting offers significant savings: up to 40% compared to non-controlled LED lighting and up to 75% compared to conventional lighting. Making it also a more sustainable choice.

EAIR system is the ideal solution for per-luminaire control of new luminaires. It combines occupancy sensing, daylight harvesting and task tuning in a single, compact package for easy luminaire assembly. An intuitive APP makes configuration and commissioning during and after installation fast and easy. EAIR system with advanced grouping functionality enables addition of qualified wireless switches. Up to 40 sensors can be grouped to a switch using APPs. In addition to easily adding user control to a space, the grouping feature facilitates auto-off/manual-on use cases. Furthermore, advanced grouping allows scene setting (e.g., presentation mode for a conference room) as well as occupancy sharing (i.e., luminaires within a group can be programmed to remain at prescribed light levels so long as occupancy is detected anywhere in the group)

EAIR (Option)

Build-in Low-bay EAIR solution



DESCRIPTION:	Build-in Bluetooth® PIR sensor and driver Body: thermoplastic, white/black/grey
FEATURES:	Occupancy control Absence detection Daylight harvest Corridor function Tuneable White Grouping luminaires Group occupancy sharing Scenes EAIR APP control
GENERAL DATA:	Mains voltage: according to product data sheet Protection class IEC: according to product data sheet Ingress protection: IP20 Operating temperature range, °C: according to product data sheet Required SR signal current: 13mA No. drivers per sensor: 4 Power consumption: <1W Dimensions: 50x19x31.5mm
INSTALLATION:	Build into the luminaire (cut-out 44x17mm)
ENVIRONMENT	Indoor
APPLICATION:	Office, education, hotel, corridor, staircase, public place

OPTION	DESCRIPTION	DETECTION RANGE, °	MAX. DIAMETER, m	MAX. HEIGHT, m
EAIRB-M	Master luminaire with integrated smart sensor and driver with Bluetooth® communication and grouping possibilities for lighting control	360	3.6x5.4	3
EAIRB-S	Slave luminaire with integrated EAIR type driver for lighting control	360	3.6x5.4	3

DETECTION DIAGRAM:

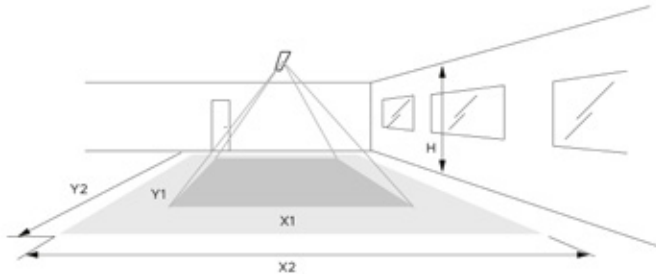

The detection area for the movement sensor can be roughly divided into two parts:

- Minor movement (person moving ≤ 0.9 m/s)
- Major movement (person moving ≥ 0.9 m/s)

Height	Minor Movement		Major Movement	
h, m	Y2, m	X1, m	Y2, m	X2, m
2.4	2.9	2.7	4.5	2.9
3	3.6	3.4	5.4	3.6

Note: Longer dimension of detection area (Y1, Y2) is parallel to longer dimension of EAIR sensor

GROUP OCCUPANCY SHARING:

EAIR includes a unique feature that enhances energy savings while maintaining aesthetics of the space. Through use of group occupancy sharing, luminaires provide full light output at occupied workstations and lower background light level at unoccupied workstations. The sensors in a defined group know if there is occupancy elsewhere in the group and will not turn off until the entire group is unoccupied.

The group occupancy sharing feature can be enabled (default)/disabled through the EAIR field apps. The group lighting behaviour can also be configured to background light level or task light level. With the group occupancy sharing disabled, the luminaire does not share its occupancy status with other luminaires or respond to the occupancy detection from the rest of the group. After installation, a group of up to 40 luminaires can be created easily and quickly using the EAIR field apps.

Note: During the group occupancy sharing, daylight harvesting still occurs automatically if enabled.

AN OPEN OFFICE APPLICATION:

Here is an example of the group occupancy sharing behaviour in an open office application:



1. Empty office. Light are off.

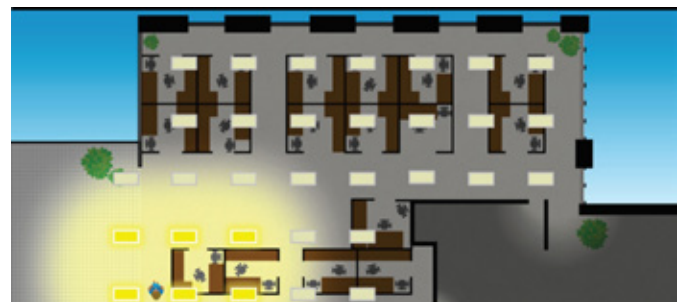

2. As people enter, lighting in their area dims up to "task level." Others in the group dim up to "background level."

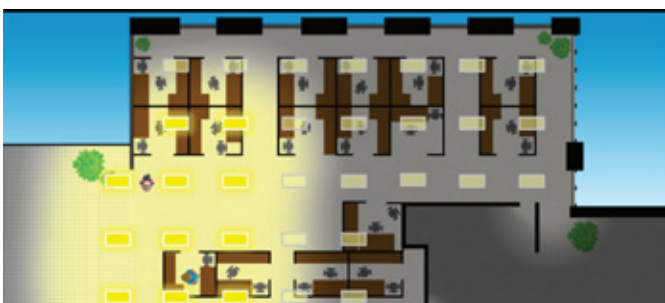

3. As additional people enter, lights in their area dim up to "task level."



4. As more workers enter, the lights dim up accordingly.



5. When the space is fully occupied, all lights are on "task level."



6. As people go to lunch or meetings, lights gently dim down to a configured "background level."



7. As people begin finishing work, additional lights dim down.

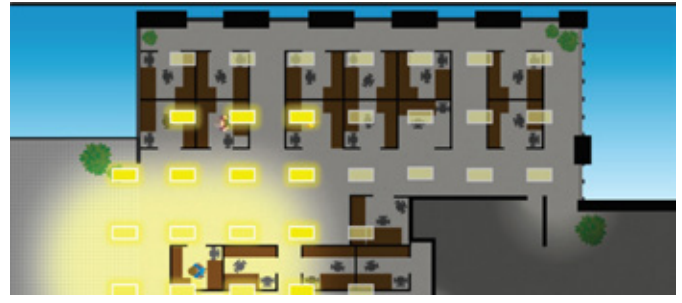

8. As the space empties, more lights dim down to the background.



9. After the last worker leaves, lights turn off after a configured "prolong time."



10. Lights turn off after a configured "prolong time."

SCENE SETTING

Light settings for meeting and conference rooms need to be flexible to fulfil a variety situational requirements. For example, audio visual presentations may require lower

light levels near the screen versus a regular meeting requiring uniform lighting on the task level. EAIR together with wireless switches and the EAIR field apps enables easy lighting configuration remotely for two scenes after the installation.

The wireless switch comes with four buttons:

- Top left button: On/Dim-up
- Bottom left button: Off/Dim-down
- Top right button: Scene 1
- Bottom right button: Scene 2

Once a scene button is pressed, the group of lights goes to the pre-set light level and does not respond to daylight variation any longer.

A CONFERENCE ROOM FOR PRESENTATIONS:



1. Empty conference room. Lights are off.

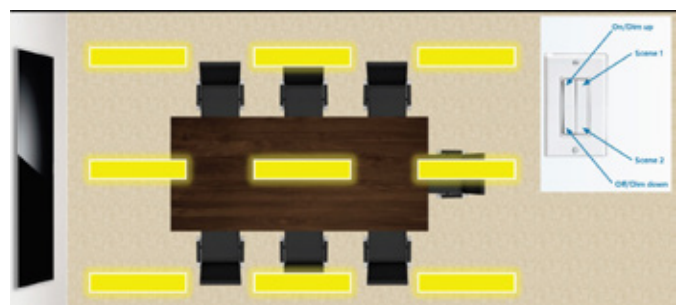

2. Pressing "On" brings lights to "task level."

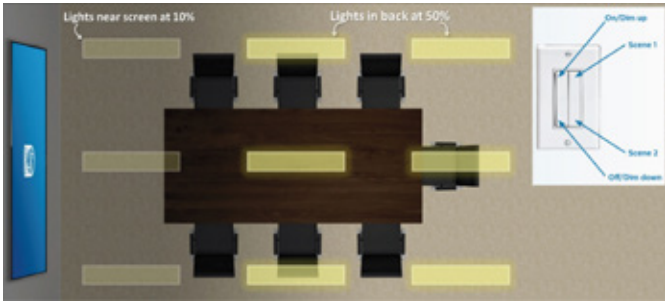

3. Pressing "Scene 1" takes lighting to pre-defined "presentation level."

AVAILABLE ACCESSORIES:



Product: Wall switch EAIRB 2B
Description: Wireless EAIRB switch and scene selector for offices



Product: Recessed MTB EAIR
Description: Recessed mounting box for EAIR sensor



Product: Wall switch EAIRB 4B
Description: Wireless EAIRB switch and scene selector for offices

AVAILABLE WITH*:

Eridanus R/S LED

Calima R/S LED

Etesian U LED

Calima U LED

Serpens LED

Decor LED



*For detailed information refer to luminaire family TDS

and others...

HBEAIR (Option)

High-bay EAIR solution



DESCRIPTION:	Batten-fit Bluetooth® EAIR high-bay sensor and driver Body: thermoplastic, light grey
FEATURES:	Occupancy control Absence detection Daylight harvesting Corridor function Tuneable White Grouping luminaires Group occupancy sharing Scenes EAIR APP control
GENERAL DATA:	Mains voltage: according to product data sheet Protection class IEC: according to product data sheet Ingress protection: IP65 Operating temperature range, °C: according to product data sheet Required SR signal current: 13mA No. drivers per sensor: 4 Power consumption: <1W Dimensions: d115x43mm
INSTALLATION:	Build into the luminaire or surface (accessory)
ENVIRONMENT:	Indoor
APPLICATION:	Industry, warehouse, cold store, hall

OPTION	DESCRIPTION	DETECTION RANGE, °	MAX. DIAMETER, m	MAX. HEIGHT, m
HBEAIRB-M	Master luminaire with integrated smart sensor for high ceiling (up to 16m) and driver with wireless communication and grouping possibilities for lighting control	360	16	16
HBEAIRB-S	Slave luminaire with integrated EAIR type driver for lighting control	360	16	16

GROUPING AND ZONING:

Grouping allows multiple luminaires to connect with each other using a Zigbee network and broadcast occupancy status. The grouped luminaires can be configured for desired behaviour for presence detection based on installer settings, e.g. the light behaviour of the rest of the luminaires can be configured for maximum brightness (called as 'field task level' in further documentation) or background light level.

Zoning allows sub-grouping of luminaires. In an industrial setup such as warehouses, it would be beneficial to have an aisle turn on to field task level while adjacent aisles switch on and go to background light level on presence detection. In another scenario, if a forklift truck enters a very long aisle, it would be beneficial only to bring the first 5 luminaires, for example, to maximum brightness/field task level and the rest of the luminaires in the aisle to background light level. This avoids the tunnel effect, driving or walking into a dark tunnel or lighting up the whole aisle unnecessarily.

A WAREHOUSE AISLE APPLICATION:

Here is an example of the group occupancy sharing and zoning behaviour in a warehouse application.



1. Luminaires can be grouped together or further divided into zones

2. Luminaires in top aisle dim up to task level by zones when motion is detected

3. Luminaires in the top aisle dim down to background level after hold time period



4. Zone 3 in bottom aisle can dim up to task level and Zones 1/2 to background level when motion is detected

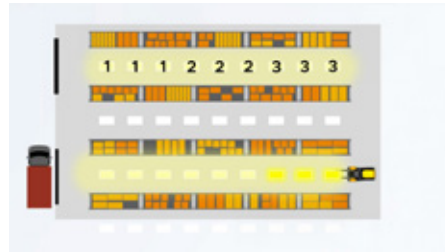

5. Zone 2 dim up from background to task level when motion is detected



6. Luminaires in top aisle turn off after prolong period expires

Note:

Place heat radiating devices outside of the monitoring cone
Avoid drafts (e.g. from ventilators or heating systems)

DETECTION DIAGRAM:

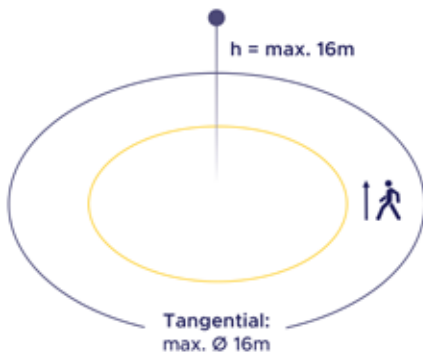

HEIGHT, m	DETECTION RANGE, m
4	3x3
8	8x8
12	12x12
16	16x16

AVAILABLE ACCESSORIES:



Product: Wall switch EAIRB 2B
Description: Wireless EAIRB switch and scene selector for offices



Product: HBEAIRB SUR
Description: Surface mounted smart sensor for high ceiling (up to 16m) with wireless communication and grouping possibilities for lighting control



Product: Wall switch EAIRB 4B
Description: Wireless EAIRB switch and scene selector for offices

AVAILABLE WITH*:

Barat LED

Sumatra LED

Norte I LED

Norte L LED



*For detailed information refer to luminaire family TDS

EAIR BRIDGE

EAIR solution for system expansion



DESCRIPTION: EAIR solution for connecting sensors with DALI or ON/OFF drivers
Body: thermoplastic, white

GENERAL DATA: Mains voltage: 220-240V, 50-60Hz
 Protection class IEC: II
 Ingress protection: IP20
 Operating temperature range, °C: -40...+60
 Control output: DALI / ON/OFF
 No. drivers per bridge: 20 DALI loads (40mA)
 Switching load: 400W
 Power consumption: <0.5W

INSTALLATION: Build into the luminaire or independent. Push-in terminals

APPLICATION: Office, education, hotel, corridor, public place, industry, warehouse, hall

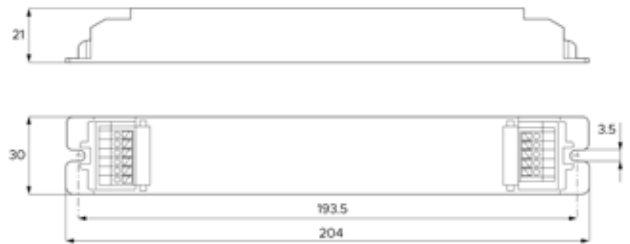

PRODUCT	LENGTH, mm	WIDTH, mm	HEIGHT, mm	MAX. AMOUNT OF DRIVERS
EAIR Bridge built-in	204	30	21	20
EAIR Bridge independent	236	30	21	20

The EAIR Bridge can be used with existing DALI luminaires to create an EAIR system. This is useful to connect e.g. multiple downlights to 1 sensor or to use 1 sensor for multiple trunking luminaires. It features all the elements of the EAIR interface like energy metering (1% accurate) and diagnostics. The sensor is connected to the bridge via the EAIR interface and on the other side DALI drivers can be connected on the DALI interface or ON/OFF relay output.

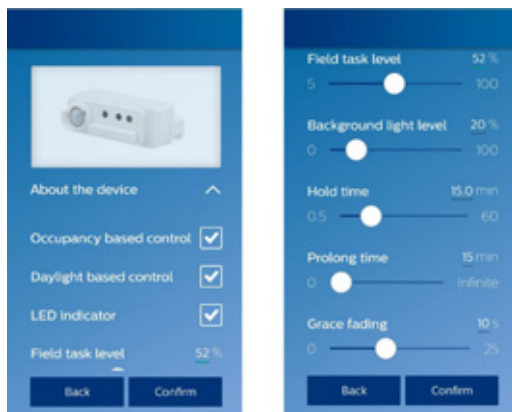

EAIR APP

User Interface

EAIR eco-system can be easily configured using app via Bluetooth® mesh:

- Configuration of parameters
 - Energy reporting
 - Grouping options: multiple luminaires, sensors and switches can be added in the groups. For proper grouping it is recommended to limit the number of luminaires (sensors) in a group to 40
 - Configuration of scenes: it is possible to store scenes on a 4-button wireless switch. A scene is a light level setting of the luminaires that can be saved on the switch
 - Maintenance of the system: installer test, reset of network settings, reset of the parameters, change of luminaire channel
- This app works via Bluetooth® Low Energy (BLE) technology and is available for free on App Store and Google Play Store

BLT WIRELESS SYSTEM



BLT WIRELESS SYSTEM

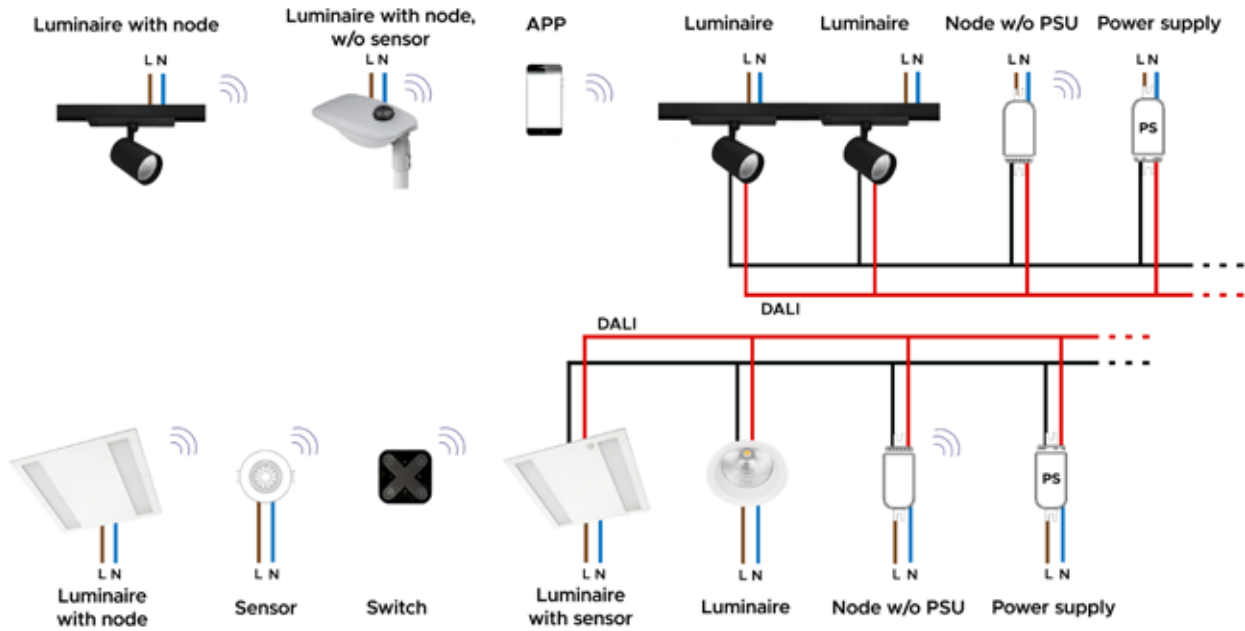

BLT is a wireless control unit for LED luminaires DALI dimming interface and acts both as a controller and as a power supply making it possible to connect directly with DALI interface without the need for an external DALI power supply. This so-called Standalone DALI makes it possible to implement multi-channel lighting systems with adjustable colour (RGB) or colour temperature, while keeping the wiring and number of components at their minimum.

BLT is controlled wirelessly with smartphone or tablet applications using Casambi application. Devices form automatically a secure wireless mesh network so that a large number of fixtures can be controlled from any point. No external gateway module is needed. BLT can be controlled also from a standard on/off wall switch.

FEATURES:

- Wirelessly controllable
- No need for an external gateway device
- Forms automatically a fast-wireless mesh network
- Digital output: Standalone DALI
- Easily implemented RGB and color temperature controls
- Controllable switched mains output
- Dimming from standard on/off wall switches
- Device firmware can be updated over-the-air
- BLT cloud service enhances user experience



BLT Node

Built-in Bluetooth® Transceiver Node



DESCRIPTION:	Built-in Bluetooth® transceiver node Body: thermoplastic, white	
FEATURES:	Grouping Scenes Animations Tuneable white Circadian rhythm	Calendar & Timer Sunset & Sunrise Control hierarchy BLT app control
GENERAL DATA:	Mains voltage: 220-240V, 50-60Hz Protection class IEC: II Ingress protection: IP20 Operating temperature range, °C: -25...+70 Control output: DALI2 DALI power supply: 0/10mA No. DALI drivers per node: 4 Power consumption: <0.4W	
INSTALLATION:	Build into the luminaire or junction box. Push-in terminal	
APPLICATION:	Office, education, hotel, public place, industry, warehouse, hall	

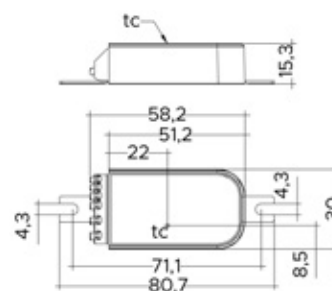

PRODUCT	LENGTH, mm	WIDTH, mm	HEIGHT, mm	CONTROL OUTPUT	BLUETOOTH® RANGE, m
BLT (powered) (basicDIM Wireless G2)	80,7	30	15,3	DALI2	10-30
BLT node (basicDIM Wireless Passive module G2)	80,7	30	15,3	DALI2	10-30



BLT Switch

Wall-Mounted Bluetooth® Touch Panel

DESCRIPTION:	Wall-mounted Bluetooth® touch panel Body: thermoplastic, white/black	
FEATURES:	Forms automatically a wireless communication network with up to 250 nodes Controls all types of BLT devices: <ul style="list-style-type: none"> ▪ 4 scenes ▪ Dim up / down ▪ Colour temperature control 	
GENERAL DATA:	Battery: CR2430 Lithium-ion Ingress protection: IP20 Operating temperature range, °C: 0...+45	
INSTALLATION:	Wall-mounted (mounting bracket and battery are included)	
APPLICATION:	Office, education, hotel, public place, industry, warehouse, hall	

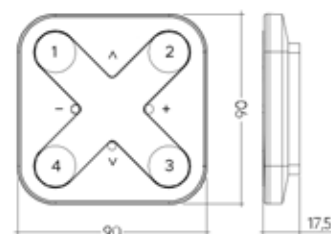

PRODUCT	LENGTH, mm	WIDTH, mm	HEIGHT, mm	BLUETOOTH® RANGE, m
BLT Switch, white (basicDIM Wireless User Interface white)	90	90	17,5	<60
BLT Switch, black (basicDIM Wireless User Interface)	90	90	17,5	<60

Xpress is a wireless user interface that brings huge flexibility to interior design as furniture can be replaced or even walls can be rebuilt without having to take wiring of switches or switch placement into account. The switch can be kept wherever the user needs it and it gives direct access to all the important Casambi lighting control functionalities.



BLT system TRACK (Option)

Track mounted Bluetooth® LED Spotlight



DESCRIPTION:	Track mounted Bluetooth® LED Spotlight Body: thermoplastic, white/black/grey
FEATURES:	Grouping Scenes Calendar & Timer Sunset & Sunrise Control hierarchy BLT app control
GENERAL DATA:	Mains voltage: 220-240V, 50-60Hz Protection class IEC: II Ingress protection: IP20 Operating temperature range, °C: according to product data sheet Power consumption: <0.5W
INSTALLATION:	In 3-phase track. Track adaptor (3-phase) with phase selector
APPLICATION:	Office, hotel, corridor, retail, showroom, museum, exhibition

OPTION	LENGTH, mm	WIDTH, mm	HEIGHT, mm	CONTROL OUTPUT	BLUETOOTH® RANGE, m
BLT	-	-	-	-	10-30



BLT APP

User Interface

APP:
The BLT app works as one of the user interfaces in a BLT lighting control solution, as the commissioning tool and as well as a remote gateway. The BLT app works with iOS as well as Android devices, like smartphones, tablets and smartwatches. The app is free to download by any end user. The BLT app is made by user interface experts and in a way, that anyone - regardless of technical proficiency - can use it. Therefore, the BLT app is equally well suitable for the professional lighting market as well as the residential field.

ADDITIONAL CONTROL ACCESSORIES

DALI Power Supply



DALI Power Supply Unit



DESCRIPTION:	DALI Power Supply Unit Body: thermoplastic, white
GENERAL DATA:	Mains voltage: 220-240V, 50-60Hz Protection class IEC: II Ingress protection: IP20 Operating temperature range, °C: 0...+65 Control output: DALI2 DALI power supply: 70mA No. DALI drivers per node: 35 DALI loads Power consumption: <0.4W
INSTALLATION:	Build into the luminaire or junction box. Push-in terminal, 4x1x1.5mm ²
APPLICATION:	Office, education, hotel, corridor, public place, industry, warehouse, hall

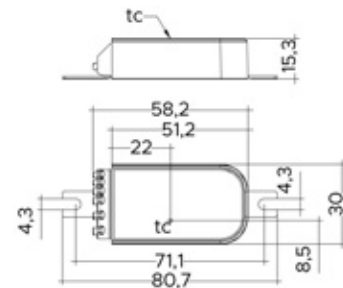

PRODUCT	LENGTH, mm	WIDTH, mm	HEIGHT, mm
DALI Power Supply (DALI PS3)	80,7	30	15,3

EMERGENCY LIGHTING SOLUTIONS

The majority of Northcliffe Lighting luminaires can be equipped with various emergency kits for different markets and different applications.

EMERGENCY OPTIONS

EM3 (NOVA LED): The emergency converter Nova LED is universal design for use with the majority of LED luminaires that work with constant power drivers. It is an emergency battery pack that uses electronic circuitry to convert energy stored in the battery into the DC voltage and current necessary to drive the LED load. The unit can be installed as maintained or non-maintained unit and it allows the same LED fixture to be used for both normal and emergency operation. Each unit includes the battery pack, LED charge indicator, a test switch and the emergency power module.

EM3B: The emergency converter using the best available technology in the market, designed for use with the majority of LED luminaires. Each unit includes the battery pack, LED charge indicator and the emergency power module. A test switch can be installed optionally.

EM3A: The emergency converter with self-test function which is universal for use with the majority of LED luminaires. Luminaires with autonomous testing system includes automatic self-diagnostic at regular intervals. Every seven days the correct performance of the module, the light and the battery is tested. Once per year the capacity of the batteries is tested simulating a mains failure and making a performance test. Two-colour status display LED indicator signalizes mains power supply and battery charge. The luminaire with autonomous testing system also has a deep discharge protection.

EM3D: The emergency converter with DALI interface and automatic test function which is universal for use with most LED luminaires and compatible with all dimmable and non-dimmable systems. All emergency units are individually addressable. Individual programming option makes it possible to use functions which transcend the DALI standard. Once per year the capacity of the batteries is tested simulating a mains failure and making a performance test. Two-colour status display LED indicator signalizes mains power supply and battery charge. The luminaire with autonomous testing system also has a deep discharge protection.



Series of EM3LOA and EM3LER emergency kits is the newest line of options that combines highly efficient LED light sources and the latest optics, designed to illuminate open areas or escape routes. A high specification LED emergency version provides high performance emergency lighting in commercial buildings where aesthetics is of prime importance, such as offices, retail or hospitality and leisure facilities. Whereas typical escape route emergency luminaires need to be spaced at every 3 to 7 meters to achieve the required illumination level, EM3LOA and EM3LER optimised optics can provide spacing up to 17 meters along the escape routes and up to 9 meters in the open areas, depending on ceiling height, that effects significantly on reduction of the number of needed emergency luminaires and, consequently, the costs of installation and subsequent maintenance.

EM3LOA: The emergency converter with additional source of light. This unit will provide 2W maximum output power at emergency mode. It is designed to be highly efficient and highly reliable. There are four functions on this unit: overcharge; over discharge; over temperature and reverse battery protection. This emergency kit works as a non-maintained, provides emergency lighting for open areas. When the mains fail, the spotlight will provide illumination for 3 hours. The emergency spotlight is simply installed in the body of the luminaire.

EM3LER: The emergency converter with additional source of light. This unit will provide 2W maximum output power at emergency mode. It is designed to be highly efficient and highly reliable. There are four functions on this unit: overcharge; over discharge; over temperature and reverse battery protection. This emergency kit works as a non-maintained, provides emergency lighting for escape route illumination. When the mains fail, the spotlight will provide illumination for 3 hours. The emergency spotlight is simply installed in the body of the luminaire.

PHOTOMETRY OF EM3LER / EM3LOA

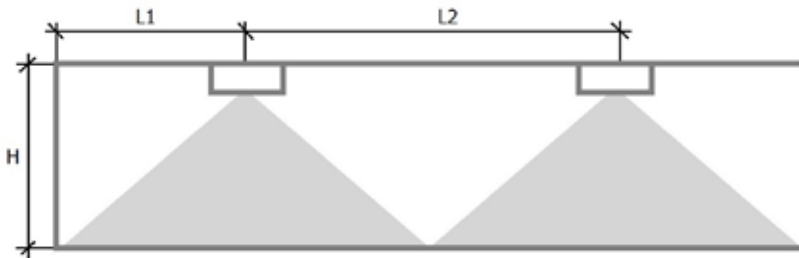

L1 - distance from the wall to the first fixture
L2 - distance between fixtures
H - height of the ceiling

LER optic for corridor route illumination: LOA optic for open area illumination:

EM3LER - 2W/184lm min. 1lx			EM3LOA - 2W/118lm min. 0,5lx		
H, m	L1, m	L2, m	H, m	L1, m	L2, m
2,5	7,5	17,0	2,5	3,5	8,0
3,0	8,0	18,5	3,0	4,0	9,0
3,5	8,0	20,0	3,5	4,5	10,0
4,0	8,0	20,0	4,0	4,5	11,0
4,5	7,0	20,0	4,5	5,0	11,5
5,0	5,0	20,0	5,0	5,0	12,0
6,0	3,5	15,0	6,0	5,0	13,0

LER

LOA

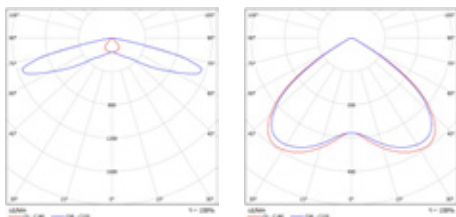

OPTION	DESCRIPTION
EM3	Emergency version 3 hours
EM3B	Emergency version 3 hours (best available technology)
EM3A	Emergency version equipped with an autonomous testing system, 3 hours
EM3D	Emergency version 3 hours with DALI interface
EM3LER	Emergency version 3 hours, lens for escape route
EM3LOA	Emergency version 3 hours, lens for open areas

AVAILABLE WITH*:

Eridanus R LED

Calima R LED

Etesian S/U LED

Calima S/U LED

Serpens LED

Decor LED



*For detailed information refer to luminaire family TDS

LED STREET LIGHTING CONTROLS

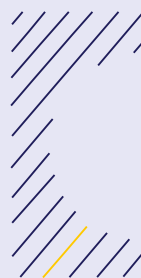

LED STREET LIGHTING CONTROLS



LED street lighting dimming feature helps to flexibly adapt street and outdoor lighting to the varied nightlife of cities and municipalities and enables significant energy savings. It offers three different control and dimming functions in single electronic control gear:

DALI – digital interface for bi-directional communication

ADIM – autonomous dimming

OPTION	DESCRIPTION
DALI	Driver with DALI interface
ADIM	Driver with autonomous mid-night dimming

ADIM – autonomous dimming is designed for dimming without any external control wiring and helps to save energy and reduce light pollution, even if only a power line is available. In ADIM operation, the street lighting fixtures executes a pre-set dimming profile, which can be factory programmed. The autonomous dimming is regulated by an integrated timer, which adjusts the dimming profile according to the previous night (operation from switch-on to switch-off).

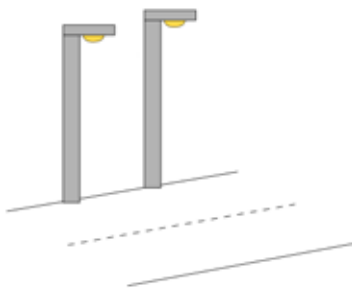

Installation without external control line for ADIM operation

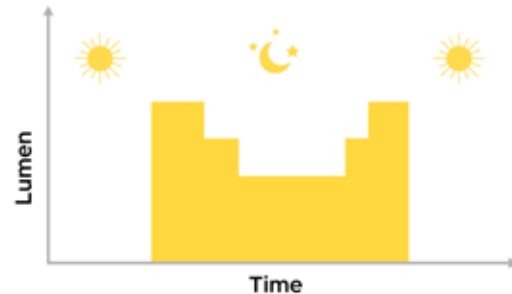

ADIM operation – light output over time: with one or two dim levels

Example: at 19 o'clock street lights are turned ON and at 6 o'clock turned OFF. In this case we have total of 11 hours long operation, middle point in this case is 5.5 hours which makes "natural midnight" at 00:30, so power goes down to 50% operation at 22:30 (00:30 – 2h), returns to 100% operation at 04:30 (00:30 + 4h). Power switch always takes average of last 4 operating times to calculate reference point. Energy savings about 70 percent. Higher energy savings can be achieved setting lower/longer operation level during night time or more power reduction steps. Please add this information when placing order.

AVAILABLE WITH*:

Auva LED



Avior LED



Boreas M LED



Signus LED



Segin LED



Squall LED



Sargas LED



*For detailed information refer to luminaire family TDS

and others...

DALI ZHAGA18 (Option)

Luminaires prepared for Zhaga18 ready sensor



DESCRIPTION:	Driver with D4i interface and integrated ZHAGA18 socket. W/O sensor Body: PBT, black
GENERAL DATA:	Ingress protection: IP66 Impact protection: IK09 Operating temperature range, °C: according to product data sheet
INSTALLATION:	Build-in to the luminaire. Zhaga18 socket
ENVIRONMENT:	Outdoor
APPLICATION:	Park, public space, street

OPTION	DESCRIPTION	LENGTH, mm	WIDTH, mm	HEIGHT, mm
DALI ZHAGA18	Driver with D4i interface and integrated ZHAGA18 socket. W/O sensor, up	36,5	36,5	27,4
DALI ZHAGA18 DOWN	Driver with D4i interface and integrated ZHAGA18 socket. W/O sensor, down	36,5	36,5	27,4
DALI 2xZHAGA18	Driver with D4i interface and integrated two ZHAGA18 sockets. W/O sensor, up&down	36,5	36,5	27,4

Zhaga18 describes a smart interface between outdoor luminaires and sensing / communication nodes. It specifies power and communication aspects in addition to the mechanical fit and electrical pins. Zhaga18 allows any certified node to operate with any certified luminaire. Certified luminaires and sensing/communication modules are available from multiple suppliers, establishing an ecosystem of compatible products. The standard simplifies the addition of nodes such as sensors and communication nodes to LED luminaires. By assuring plug-and-play interoperability, the entire value chain benefits. It reduces complexity and adds value for the luminaire maker, installer and the specifier.

BLT ZHAGA18

Outdoor Bluetooth® Transceiver Node
Zhaga18 ready solution



DESCRIPTION: Outdoor Bluetooth® Transceiver Node
Body: polycarbonate, transparent

FEATURES: Grouping
Scenes
Calendar & Timer
Sunset & Sunrise
Control hierarchy
BLT app control

GENERAL DATA: Mains voltage: 220-240V, 50-60Hz
Life time, h: 100000
Ingress protection: IP66
Impact protection: IK09
Operating temperature range, °C: -40...+70
Control output: DALI
Power consumption: 0.16W
Required DALI current: 13mA

INSTALLATION: Build-in to the luminaire. Zhaga18 socket

ENVIRONMENT: Outdoor

APPLICATION: Park, public space, street

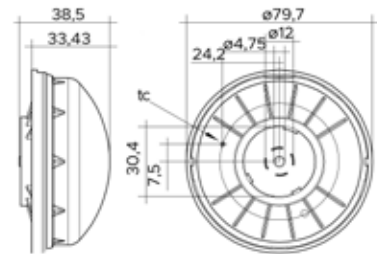

PRODUCT	LENGTH, mm	WIDTH, mm	HEIGHT, mm	CONTROL OUTPUT	BLUETOOTH® RANGE, m
BLT ZHAGA18 (basicDIM Wireless OTD)	80	80	38,5	DALI	<150

DETECTION DIAGRAM:

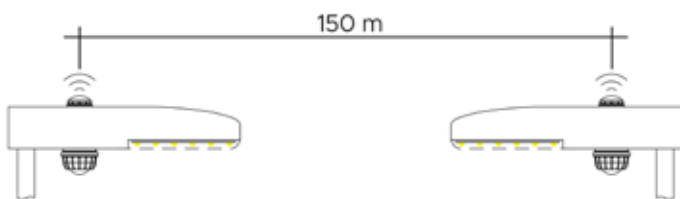

AVAILABLE WITH*:

Auva LED

Avior LED



*For detailed information refer to luminaire family TDS

NIGHT SWITCHES





NIGHTSWITCH ZHAGA18

Night switch Zhaga18 ready solution



- DESCRIPTION:** **Night switch**
Body: polycarbonate, light grey/dark grey
- GENERAL DATA:** **Ingress protection:** IP66
Operating temperature range, °C: -20...+80
Switching delay: 10s
Response brightness: 20lx
- INSTALLATION:** Build-in to the luminaire. Zhaga18 socket
- ENVIRONMENT:** Outdoor
- APPLICATION:** Park, public space, street



PRODUCT	DESCRIPTION	LENGTH, mm	WIDTH, mm	HEIGHT, mm
Nightswitch Zhaga18 (HALO 20Lux 1:1 (no trim))	IP66, Zhaga18 photo-sensor measures ambient brightness with DALI controls	53	53	21
Nightswitch Zhaga18 IK09 (HALO Heavy Duty 20Lux 1:1 (no trim))	IP66, Zhaga18 photo-sensor measures ambient brightness with DALI controls, IK09	53	53	21



NIGHTSWITCH



- DESCRIPTION:** **Nightswitch**
Body: polycarbonate, white
- GENERAL DATA:** **Mains voltage:** 220-240V, 50-60Hz
Protection class IEC: I
Ingress protection: IP55
Operating temperature range, °C: -20...+50
Power consumption: <1.8W
Switching load: 1000W
Switching delay: 15-30s
Response brightness: 3-1000lx
Variable switching level: 'Delay Off', 2, 4, 6, 8h
- INSTALLATION:** Wall-mounted. Screw terminal, 4x1x1.5mm²
- ENVIRONMENT:** Outdoor
- APPLICATION:** Park, public space, street

PRODUCT	DESCRIPTION	LENGTH, mm	WIDTH, mm	HEIGHT, mm
NIGHTSWITCH	IP55, photo-sensor measures ambient brightness and switches ON/OFF, white	105	79	36

Functionality:

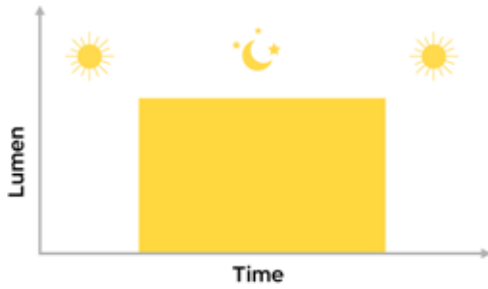

Nightswitch measures ambient brightness and automatically switches on connected lighting fixtures when darkness falls and switches off again at the dawn.

Note: Make sure that the NIGHTSWITCH is not affected by light from light fixtures to which it is connected (by light shining directly on the sensor)



PCA (Option)

Built-In Night Switch



- DESCRIPTION:** **Built-In Night Switch**
Body: polycarbonate, transparent
-
- GENERAL DATA:** **Mains voltage:** 220-240V, 50-60Hz
Protection class IEC: II
Ingress protection: IP66
Operating temperature range, °C: -20...+80
Power consumption: <0.25W
Switching load: 1200W
Switching delay: 15-30s
Response brightness: 35lx

INSTALLATION: Build-in to the luminaire (cut-out d20mm)

ENVIRONMENT: Outdoor

APPLICATION: Park, public space, street

OPTION	DESCRIPTION
PCA	Photocell 20mm miniature type, IP66, 35 lux; 1:05 ratio; ON/OFF

Functionality:

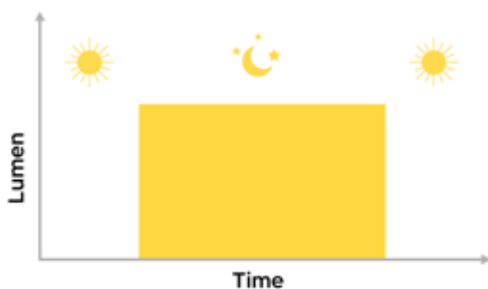

Mini-night switch PCA switches lighting fixture ON or OFF, at the same time it can be mounted into IP protected light fitting serving as standalone solution. The built-in photo-sensor records the brightness of the surroundings and switches the connected lighting fixture on at dusk and off again at dawn. The product is made up of a special lens arrangement developed to maximise acceptance angle, improving accuracy and consistency of switching. Additionally, the range uses superior quality components throughout and includes a predictive load transfer switching algorithm to minimise switching

AVAILABLE WITH*:

Auva LED



Avior LED



Boreas M LED



Signus LED



Segin LED



Squall LED



Sargas LED



*For detailed information refer to luminaire family TDS

and others...

RECESSED LUMINAIRES



ERIDANUS R LED

Recessed Luminaires

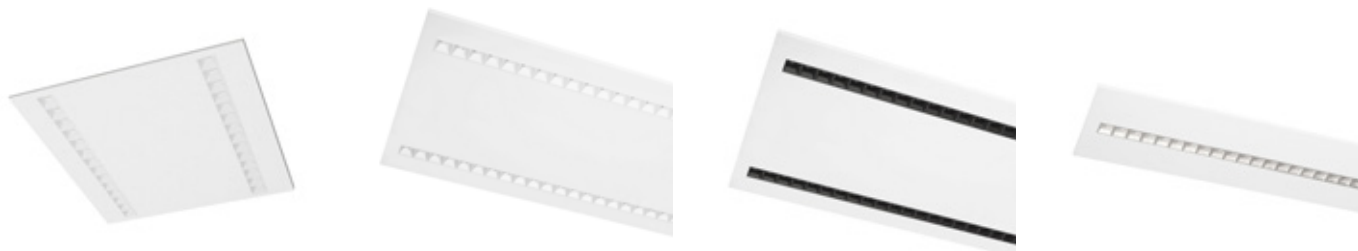
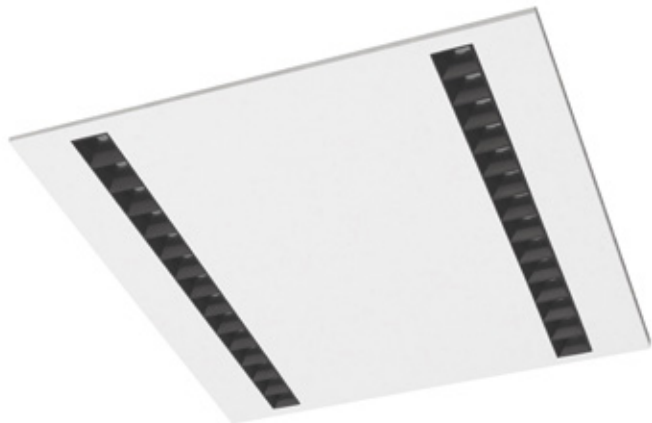
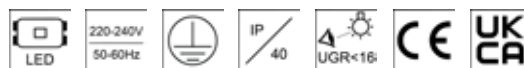

- DESCRIPTION:** **Recessed mounted LED luminaire**
Light distribution type: direct
Optical system: double parabolic reflector with lenses, low glare
Housing: steel
Colour: white, RAL9003S
-
- GENERAL DATA:** **Mains voltage:** 220-240V, 0/50-60Hz
LED lifetime, h: 100000/L80B10
SDCM: 3
Protection class IEC: I
Ingress protection code: IP40/20
Mechanical impact resistance: IK05
Operating temperature range, °C: ta 0...+35
-
- INSTALLATION:** In modular suspended ceilings, in ceilings with cut-out openings (optional). Push-in terminal, 3x2x2.5mm²
-
- ENVIRONMENT:** Indoor
-
- APPLICATION:** Office, education, corridor, retail, public place

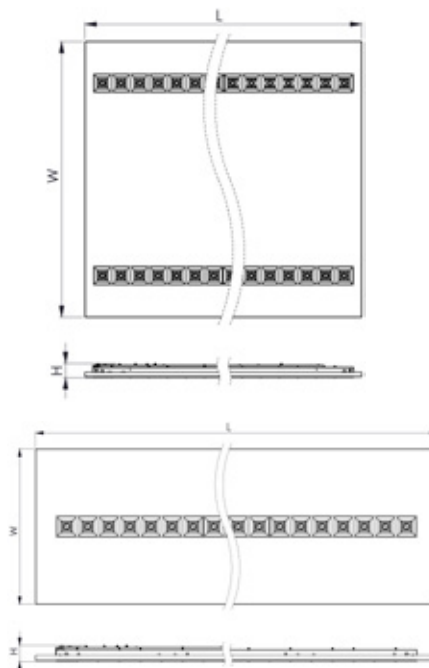

PRODUCT	LENGTH, mm	WIDTH, mm	HEIGHT, mm	LUMINAIRE OUTPUT*, lm	SYSTEM POWER*, W	SYSTEM EFFICACY*, lm/W	CRI	CCT*, K	WEIGHT, kg
Eridanus R LED1x1500 G950 T840 WGC	595	295	31	1460	9,2	159	80+	4000	1,7
Eridanus R LED1x1800 G951 T840 WGC	595	295	31	1791	11,1	161	80+	4000	1,7
Eridanus R LED1x2150 G952 T840 WGC	595	295	31	2111	13,4	158	80+	4000	1,7
Eridanus R LED1x2450 G953 T840 WGC	595	295	31	2433	15,7	155	80+	4000	1,7
Eridanus R LED2x1500 G954 T840 WGC	595	595	31	2920	17,6	166	80+	4000	2,7
Eridanus R LED2x1800 G955 T840 WGC	595	595	31	3583	21,9	164	80+	4000	2,7
Eridanus R LED2x2150 G956 T840 WGC	595	595	31	4222	26,1	162	80+	4000	2,7
Eridanus R LED2x2450 G957 T840 WGC	595	595	31	4867	30,8	158	80+	4000	2,7
Eridanus R LED1x2950 G958 T840 WGC	1195	295	31	2920	17,6	166	80+	4000	2,8
Eridanus R LED1x3600 G959 T840 WGC	1195	295	31	3583	21,9	164	80+	4000	2,8
Eridanus R LED1x4250 G960 T840 WGC	1195	295	31	4222	26,1	162	80+	4000	2,8

PRODUCT	LENGTH, mm	WIDTH, mm	HEIGHT, mm	LUMINAIRE OUTPUT*, lm	SYSTEM POWER*, W	SYSTEM EFFICACY*, lm/W	CRI	CCT*, K	WEIGHT, kg
Eridanus R LED1x4900 G961 T840 WGC	1195	295	31	4867	30,8	158	80+	4000	2,8
Eridanus R LED2x2950 G962 T840 WGC	1195	595	31	5840	33,7	173	80+	4000	4,8
Eridanus R LED2x3600 G963 T840 WGC	1195	595	31	7165	41,9	171	80+	4000	4,8
Eridanus R LED2x4250 G964 T840 WGC	1195	595	31	8445	50,5	167	80+	4000	4,8
Eridanus R LED2x4900 G965 T840 WGC	1195	595	31	9733	58,9	165	80+	4000	4,8
Eridanus R LED1x1350 G950 T840 BGC	595	295	31	1348	9,2	147	80+	4000	1,7
Eridanus R LED1x1700 G951 T840 BGC	595	295	31	1654	11,1	149	80+	4000	1,7
Eridanus R LED1x1950 G952 T840 BGC	595	295	31	1949	13,4	145	80+	4000	1,7
Eridanus R LED1x2250 G953 T840 BGC	595	295	31	2246	15,7	143	80+	4000	1,7
Eridanus R LED2x1350 G954 T840 BGC	595	595	31	2696	17,6	153	80+	4000	2,7
Eridanus R LED2x1700 G955 T840 BGC	595	595	31	3307	21,9	151	80+	4000	2,7
Eridanus R LED2x1950 G956 T840 BGC	595	595	31	3898	26,1	149	80+	4000	2,7
Eridanus R LED2x2250 G957 T840 BGC	595	595	31	4492	30,8	146	80+	4000	2,7
Eridanus R LED1x2700 G958 T840 BGC	1195	295	31	2696	17,6	153	80+	4000	2,8
Eridanus R LED1x3350 G959 T840 BGC	1195	295	31	3307	21,9	151	80+	4000	2,8
Eridanus R LED1x3900 G960 T840 BGC	1195	295	31	3898	26,1	149	80+	4000	2,8
Eridanus R LED1x4500 G961 T840 BGC	1195	295	31	4492	30,8	146	80+	4000	2,8
Eridanus R LED2x2700 G962 T840 BGC	1195	595	31	5391	33,7	160	80+	4000	4,8
Eridanus R LED2x3350 G963 T840 BGC	1195	595	31	6614	41,9	158	80+	4000	4,8
Eridanus R LED2x3900 G964 T840 BGC	1195	595	31	7795	50,5	154	80+	4000	4,8
Eridanus R LED2x4500 G965 T840 BGC	1195	595	31	8985	58,9	153	80+	4000	4,8

*Tolerance range for optical and electrical data: ±10%. Values apply to an ambient temperature of 25°C. NORTHCLIFFE LIGHTING is constantly developing and improving its products. The right is reserved to change any product specifications without prior notification

OPTIONS AVAILABLE ON REQUEST:

LED	REFLECTOR AND OPTICS	CONTROL GEAR	SENSORS	EMERGENCY	CONNECTION	OTHER	COLOUR
T830	WGC	DALI	PIR	EM3 ⁵	WIE3-0.5m	W625	RAL
T840	BGC	EAIRB-M ^{1 2 3 4}		EM3B ⁵	WIE5D-0.5m	SB	
	WMC	EAIRB-S ^{2 3 4}		EM3A ⁵	Schuko-1.5m	DROP T24	
	BMC	COR		EM3D ⁵	Schuko-3.0m	DROP T15	
	MGC	COR1min		EM3LER ⁵			
	MMC	COR30min		EM3LOA ⁵			
	WAC/BAC						

- 1 Ingress protection IP20
- 2 Max system size 1x EAIRB-M + 3x EAIRB-S
- 3 Max wire length from EAIRB-M to last EAIRB-S - 11 m
- 4 EAIRB options are not applicable for models: G950; G951
- 5 Luminaire EM versions are supplied with higher external gearbox

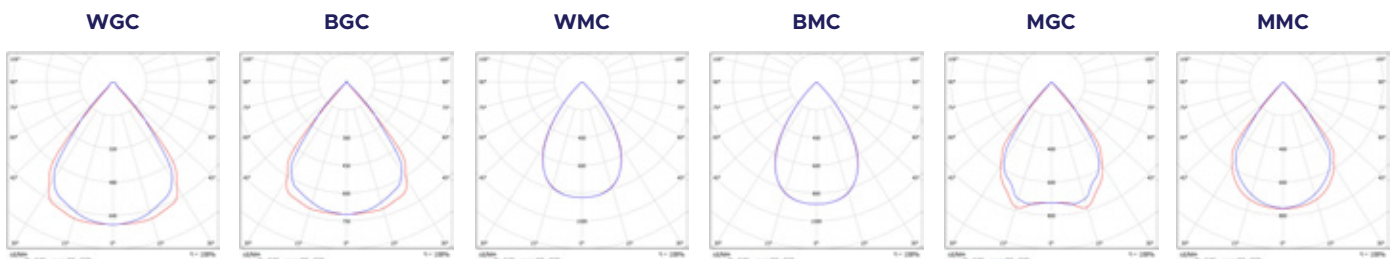

WAC/BAC

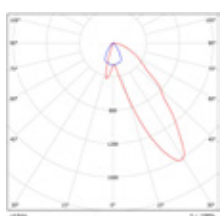

LUMINAIRE VERSION FOR DROP TILE STYLE SUSPENDED CEILINGS (DROP T24; DROP T15)

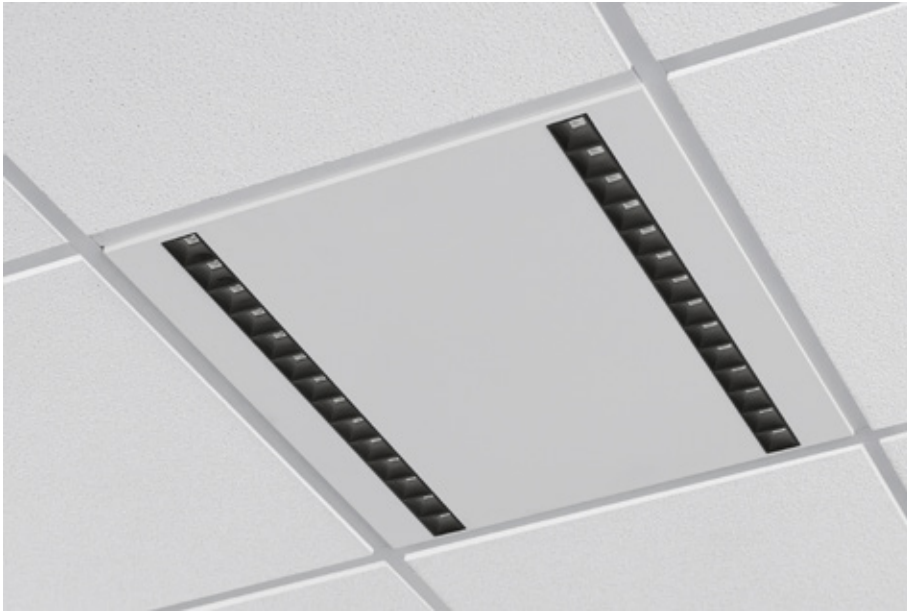

ERIDANUS I LED

Recessed Luminaires



DESCRIPTION: **Recessed mounted LED luminaire**
Light distribution type: direct
Optical system: double parabolic reflector with lenses, low glare
Housing: steel
Colour: white, RAL9003S

GENERAL DATA: **Mains voltage:** 220-240V, 0/50-60Hz
LED lifetime, h: 100000/L80B10
SDCM: 3
Protection class IEC: I
Ingress protection code: IP40
Mechanical impact resistance: IK05
Operating temperature range, °C: ta 0...+35

INSTALLATION: In ceilings with cut-out openings. Push-in terminal, 3x2x2.5mm²

ENVIRONMENT: Indoor

APPLICATION: Office, education, corridor, retail, public place

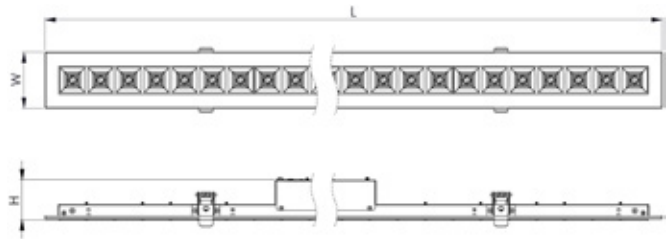

PRODUCT	LENGTH, mm	WIDTH, mm	HEIGHT, mm	CUT-OUT, mm	LUMINAIRE OUTPUT*, lm	SYSTEM POWER*, W	SYSTEM EFFICACY*, lm/W	CRI	CCT*, K	WEIGHT, kg
Eridanus I LED1x1500 J221 T840 WGC	600	80	62	570x70	1460	9,7	151	80+	4000	1,3
Eridanus I LED1x1800 J222 T840 WGC	600	80	62	570x70	1791	11,3	158	80+	4000	1,3
Eridanus I LED1x2150 J223 T840 WGC	600	80	62	570x70	2111	13,8	153	80+	4000	1,3
Eridanus I LED1x2450 J224 T840 WGC	600	80	62	570x70	2433	16,3	149	80+	4000	1,3
Eridanus I LED1x2950 J225 T840 WGC	1156	80	62	1128x70	2920	17,6	166	80+	4000	1,7
Eridanus I LED1x3600 J226 T840 WGC	1156	80	62	1128x70	3583	21,9	164	80+	4000	1,7
Eridanus I LED1x4250 J227 T840 WGC	1156	80	62	1128x70	4223	26,1	162	80+	4000	1,7
Eridanus I LED1x4900 J228 T840 WGC	1156	80	62	1128x70	4867	30,8	158	80+	4000	1,7
Eridanus I LED1x1350 J221 T840 BGC	600	80	62	570x70	1348	9,7	139	80+	4000	1,3
Eridanus I LED1x1700 J222 T840 BGC	600	80	62	570x70	1654	11,3	146	80+	4000	1,3
Eridanus I LED1x1950 J223 T840 BGC	600	80	62	570x70	1949	13,8	141	80+	4000	1,3
Eridanus I LED1x2250 J224 T840 BGC	600	80	62	570x70	2246	16,3	138	80+	4000	1,3
Eridanus I LED1x2700 J225 T840 BGC	1156	80	62	1128x70	2695	17,6	153	80+	4000	1,7
Eridanus I LED1x3350 J226 T840 BGC	1156	80	62	1128x70	3307	21,9	151	80+	4000	1,7
Eridanus I LED1x3900 J227 T840 BGC	1156	80	62	1128x70	3898	26,1	149	80+	4000	1,7
Eridanus I LED1x4500 J228 T840 BGC	1156	80	62	1128x70	4492	30,8	146	80+	4000	1,7

*Tolerance range for optical and electrical data: ±10%. Values apply to an ambient temperature of 25°C. NORTHCLIFFE LIGHTING is constantly developing and improving its products. The right is reserved to change any product specifications without prior notification

OPTIONS AVAILABLE ON REQUEST:

LED	REFLECTOR AND OPTICS	CONTROL GEAR	EMERGENCY	CONNECTION	COLOUR
T830	WGC	DALI	EM3	WIE3	RAL
T840	BGC	EAIRB-S ^{1,2}	EM3B	WIE5	
	WMC	BLT	EM3A	WIE5D	
	BMC	COR	EM3D	2WIE3	
	MGC	COR1min		Schuko-1.5m	
	MMC	COR30min		Schuko-3.0m	
	WAC/BAC				

1 Max system size 1x EAIRB-M + 3x EAIRB-S
2 Max wire length from EAIRB-M to last EAIRB-S - 11 m

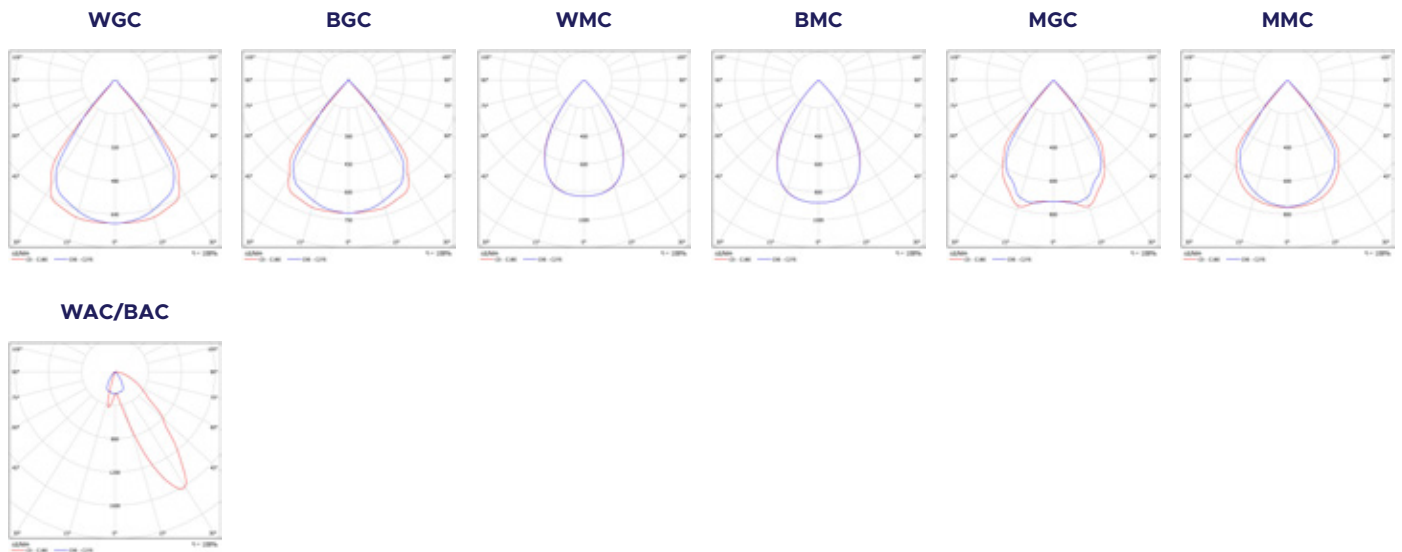

ERIDANUS G LED

Recessed Luminaires



DESCRIPTION: **Recessed mounted LED luminaire**
Light distribution type: direct
Optical system: double parabolic reflector with lenses, low glare
Housing: steel
Colour: white, RAL9003S

GENERAL DATA: **Mains voltage:** 220-240V, 50-60Hz
LED lifetime, h: 100000/L80B10
SDCM: 3
Protection class IEC: II
Ingress protection code: IP40
Mechanical impact resistance: IK05
Operating temperature range, °C: ta 0...+35

INSTALLATION: In metal grid suspended ceilings. Luminaire from two parts and single gearbox can be installed into every next tile, or optionally into every fourth tile

ENVIRONMENT: Indoor

APPLICATION: Office, education, corridor, retail, public place

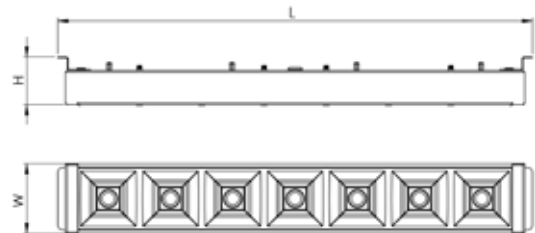

PRODUCT	LENGTH, mm	WIDTH, mm	HEIGHT, mm	LUMINAIRE OUTPUT*, lm	SYSTEM POWER*, W	SYSTEM EFFICACY*, lm/W	CRI	CCT*, K	WEIGHT, kg
Eridanus G LED1x750 J838 T840 WGC	305	45	31	730	4,9	149	80+	4000	1,3
Eridanus G LED1x900 J839 T840 WGC	305	45	31	896	6,1	147	80+	4000	1,3
Eridanus G LED1x1100 J840 T840 WGC	305	45	31	1056	7,4	143	80+	4000	1,3
Eridanus G LED2x1x750 J841 T840 WGC	305	45	31	1460	9	162	80+	4000	1,3
Eridanus G LED2x1x900 J842 T840 WGC	305	45	31	1792	11,1	161	80+	4000	1,3
Eridanus G LED2x1x1100 J843 T840 WGC	305	45	31	2111	13,4	158	80+	4000	1,3

*Tolerance range for optical and electrical data: ±10%. Values apply to an ambient temperature of 25°C. NORTHCLIFFE LIGHTING is constantly developing and improving its products. The right is reserved to change any product specifications without prior notification

OPTIONS AVAILABLE ON REQUEST:

LED	REFLECTOR AND OPTICS	CONTROL GEAR	EMERGENCY	CONNECTION
T830	WGC	DALI	EM3 ¹	WIE3-0.5m
T840	BGC		EM3B ¹	WIE5D-0.5m
	WMC		EM3A ¹	Europlug-1.5m
	BMC		EM3D ¹	Europlug-3.0m
	MGC			QBX2-0.1m
	MMC			CONCB/4 ²
	WAC/BAC			

1 Emergency LED indicator is designed to be installed separately from the luminaire body

2 CONCB/4 option is only available for models: J841...J843

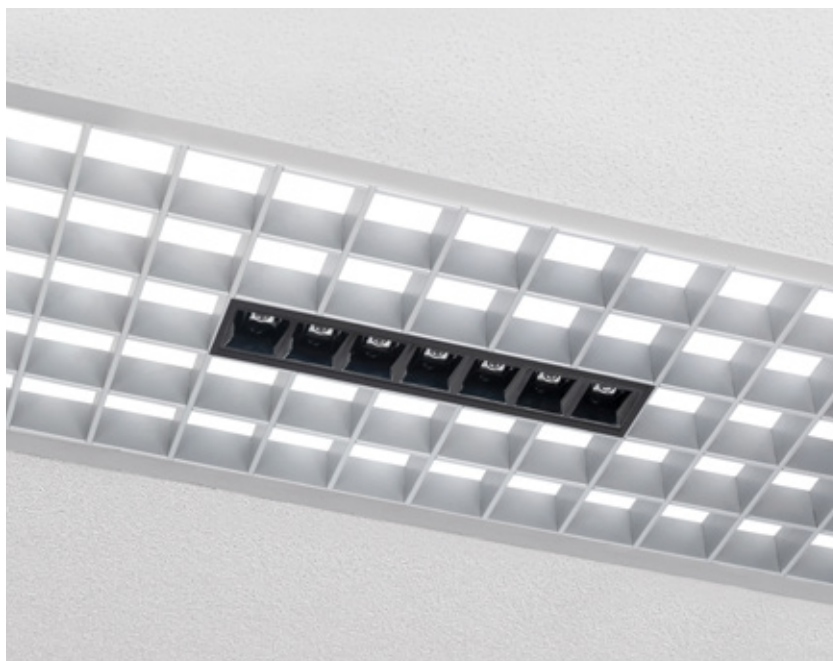
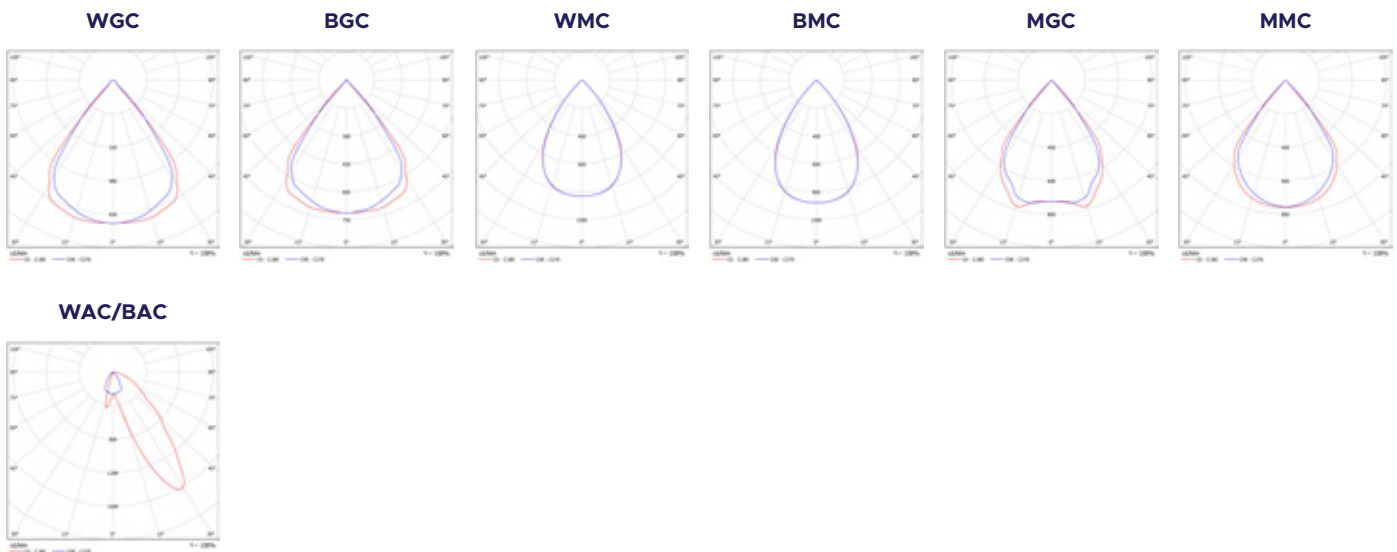

CALIMA R LED

Recessed Luminaires



DESCRIPTION: **Recessed mounted LED luminaire**
Light distribution type: direct
Optical system: matt micro-prismatic PMMA diffuser, low glare / translucent micro-prismatic PMMA diffuser
Housing: steel
Colour: white, RAL9003S

GENERAL DATA: **Mains voltage:** 220-240V, 0/50-60Hz, basic version: 220-240V, 50-60Hz
LED lifetime, h: 100000/L80B10, basic version: 50000/L80B10
SDCM: 3
Protection class IEC: I
Ingress protection code: IP44/20
Mechanical impact resistance: IK05
Operating temperature range, °C: ta 0...+35

INSTALLATION: In modular suspended ceilings (600), in ceilings with cut-out openings (mounting frame to be ordered separately). Push-in terminal, 3x2x2.5mm²

ENVIRONMENT: Indoor

APPLICATION: Office, education, corridor, retail, public place

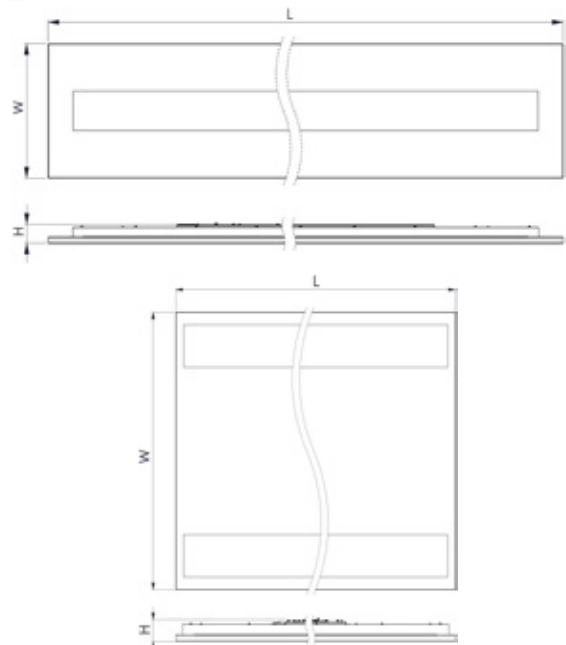

PRODUCT	LENGTH, mm	WIDTH, mm	HEIGHT, mm	LUMINAIRE OUTPUT*, lm	SYSTEM POWER*, W	SYSTEM EFFICACY*, lm/W	CRI	CCT*, K	WEIGHT, kg
Calima R LED1x1350 G135 T840 DPRZ LT80	595	295	47	1345	9,1	147	80+	4000	2,0
Calima R LED1x1900 G136 T840 DPRZ LT80	595	295	47	1863	13,3	140	80+	4000	2,0
Calima R LED1x2800 G137 T840 DPRZ LT80	595	295	47	2794	19,9	140,4	80+	4000	2,0
Calima R LED2x1350 G138 T840 DPRZ LT80	595	595	47	2689	17,1	157,3	80+	4000	3,9
Calima R LED2x1950 G139 T840 DPRZ LT80	595	595	47	3897	28,6	136,3	80+	4000	3,9
Calima R LED2x2550 G140 T840 DPRZ LT80	595	595	47	5098	33,7	151	80+	4000	3,9
Calima R LED3x1350 G141 T840 DPRZ LT80	595	595	47	4034	25,9	156	80+	4000	4,2
Calima R LED3x1900 G142 T840 DPRZ LT80	595	595	47	5589	38,4	145	80+	4000	4,2
Calima R LED3x2550 G143 T840 DPRZ LT80	595	595	47	7646	50,6	151	80+	4000	4,2
Calima R LED1x2700 G144 T840 DPRZ LT80	1195	295	47	2689	17,1	157,3	80+	4000	3,5
Calima R LED1x3900 G145 T840 DPRZ LT80	1195	295	47	3897	28,6	136,3	80+	4000	3,5
Calima R LED1x5100 G146 T840 DPRZ LT80	1195	295	47	5098	33,7	151	80+	4000	3,5
Calima R LED2x2700 G147 T840 DPRZ LT80	1195	595	47	5379	34,5	156	80+	4000	6,2
Calima R LED2x3750 G148 T840 DPRZ LT80	1195	595	47	7452	50,7	147	80+	4000	6,2
Calima R LED2x5100 G149 T840 DPRZ LT80	1195	595	47	10143	65,1	156	80+	4000	6,2

PRODUCT	LENGTH, mm	WIDTH, mm	HEIGHT, mm	LUMINAIRE OUTPUT*, lm	SYSTEM POWER*, W	SYSTEM EFFICACY*, lm/W	CRI	CCT*, K	WEIGHT, kg
Calima R LED1x1450 G135 T840 MPRZ LT92	595	295	47	1440	9,1	158	80+	4000	2,0
Calima R LED1x2000 G136 T840 MPRZ LT92	595	295	47	1994	13,3	150	80+	4000	2,0
Calima R LED1x3000 G137 T840 MPRZ LT92	595	295	47	2992	19,9	150	80+	4000	2,0
Calima R LED2x1450 G138 T840 MPRZ LT92	595	595	47	2879	17,1	168,4	80+	4000	3,9
Calima R LED2x2100 G139 T840 MPRZ LT92	595	595	47	4172	28,6	145,9	80+	4000	3,9
Calima R LED2x2750 G140 T840 MPRZ LT92	595	595	47	5457	33,7	162	80+	4000	3,9
Calima R LED3x1450 G141 T840 MPRZ LT92	595	595	47	4319	25,9	167	80+	4000	4,2
Calima R LED3x2000 G142 T840 MPRZ LT92	595	595	47	5983	38,4	156	80+	4000	4,2
Calima R LED3x2750 G143 T840 MPRZ LT92	595	595	47	8186	50,6	162	80+	4000	4,2
Calima R LED1x2900 G144 T840 MPRZ LT92	1195	295	47	2879	17,1	168,4	80+	4000	3,5
Calima R LED1x4200 G145 T840 MPRZ LT92	1195	295	47	4172	28,6	145,9	80+	4000	3,5
Calima R LED1x5500 G146 T840 MPRZ LT92	1195	295	47	5457	33,7	162	80+	4000	3,5
Calima R LED2x2900 G147 T840 MPRZ LT92	1195	595	47	5758	34,5	167	80+	4000	6,2
Calima R LED2x4000 G148 T840 MPRZ LT92	1195	595	47	7978	50,7	157	80+	4000	6,2
Calima R LED2x5450 G149 T840 MPRZ LT92	1195	595	47	10859	65,1	167	80+	4000	6,2

Basic version

Calima R LED2x1800 H131 T840 DPRZ LT80	595	595	47	2689	17,3	156	80+	4000	3,6
Calima R LED2x2150 H132 T840 DPRZ LT80	595	595	47	3897	25,8	151	80+	4000	3,6
Calima R LED2x2550 H133 T840 DPRZ LT80	595	595	47	5098	32,6	156	80+	4000	3,6
Calima R LED1x3550 H134 T840 DPRZ LT80	1195	295	47	2689	17,1	157,3	80+	4000	3,5
Calima R LED1x4300 H135 T840 DPRZ LT80	1195	295	47	3897	28,6	136,3	80+	4000	3,5
Calima R LED1x5100 H136 T840 DPRZ LT80	1195	295	47	5098	32,6	156	80+	4000	3,6
Calima R LED2x1900 H131 T840 MPRZ LT92	595	595	47	2879	17,3	167	80+	4000	3,6
Calima R LED2x2300 H132 T840 MPRZ LT92	595	595	47	4172	25,8	162	80+	4000	3,6
Calima R LED2x2750 H133 T840 MPRZ LT92	595	595	47	5457	32,6	167	80+	4000	3,6
Calima R LED1x3800 H134 T840 MPRZ LT92	1195	295	47	2879	17,1	168,4	80+	4000	3,5
Calima R LED1x4600 H135 T840 MPRZ LT92	1195	295	47	4172	28,6	145,9	80+	4000	3,5
Calima R LED1x5450 H136 T840 MPRZ LT92	1195	295	47	5457	32,6	167	80+	4000	3,6

*Tolerance range for optical and electrical data: ±10%. Values apply to an ambient temperature of 25°C. NORTHCLIFFE LIGHTING is constantly developing and improving its products. The right is reserved to change any product specifications without prior notification

OPTIONS AVAILABLE ON REQUEST:

LED	REFLECTOR AND OPTICS	CONTROL GEAR	SENSORS	EMERGENCY	CONNECTION	OTHER	COLOUR
T830	DPRZ LT80	DALI	PIR	EM3	WIE3	W625	RAL
T840	MPRZ LT92	EAIRB-M* 1 2 3 4		EM3B	WIE5	DROP T24	
T930	OP TP(a)	EAIRB-S* 2 3 4		EM3A	WIE5D	DROP T15	
T940		BLT		EM3D	Schuko-1.5m		
		TW*		EM3LER	Schuko-3.0m		
		BLT TW*		EM3LOA			
		COR					
		COR1min					
		COR30min					

1 Ingress protection IP20

2 Max system size 1x EAIRB-M + 3x EAIRB-S

3 Max wire length from EAIRB-M to last EAIRB-S - 11 m

4 EAIRB option not applicable for models: G135, G136

* Not applicable for basic version

AVAILABLE ACCESSORIES:



Product: Recessed MTG FRAME
S626x626 RAL9003S
Description: Frame for LED luminaire
595x595mm installation into plasterboard
ceiling (1pcs), white steel



Product: Recessed MTG FRAME
S326x1226 RAL9003S
Description: Frame for LED luminaire
1195x295mm installation into plasterboard
ceiling (1pcs), white steel

DPRZ LT80

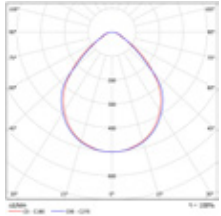

MPRZ LT92

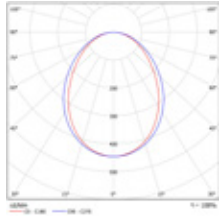

**LUMINAIRE VERSION FOR DROP TILE STYLE SUSPENDED
CEILING (DROP T24; DROP T15)**





WING R LED

Recessed Luminaires

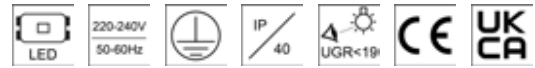

DESCRIPTION: **Recessed mounted LED luminaire**
Light distribution: direct/indirect
Optical system: matt micro-prismatic PMMA diffuser, low glare
Housing: steel
Colour: white, RAL9003

GENERAL DATA: **Mains voltage:** 220-240V, 0/50-60Hz
LED lifetime, h: 100000/L80B10
SDCM: 3
Protection class IEC: I
Ingress protection code: IP40/20
Mechanical impact resistance: IK02
Operating temperature range, °C: ta 0...+35

INSTALLATION: In modular suspended ceilings (600), in ceilings with cut-out openings (mounting frame to be ordered separately). Push-in terminal, 3x2x2.5mm²

ENVIRONMENT: Indoor

APPLICATION: Office, education, corridor, retail, public place

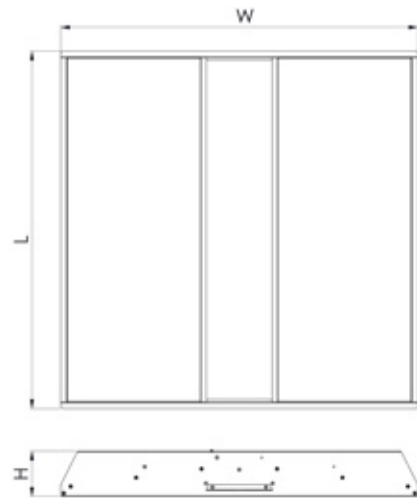

PRODUCT	LENGTH, mm	WIDTH, mm	HEIGHT, mm	LUMINAIRE OUTPUT*, lm	SYSTEM POWER*, W	SYSTEM EFFICACY*, lm/W	CRI	CCT*, K	WEIGHT, kg
Wing R LED1x3300 G882 T840 DPRZ LT80	595	595	75	3288	25,9	127	80+	4000	3,7
Wing R LED1x4500 G883 T840 DPRZ LT80	595	595	75	4498	33,7	133	80+	4000	3,7

*Tolerance range for optical and electrical data: ±10%. Values apply to an ambient temperature of 25°C. NORTHCLIFFE LIGHTING is constantly developing and improving its products. The right is reserved to change any product specifications without prior notification

OPTIONS AVAILABLE ON REQUEST:

LED	REFLECTOR AND OPTICS	CONTROL GEAR	EMERGENCY	CONNECTION
T830	DPRZ LT80	DALI	EM3	WIE3
T840	OP TP(a)	EAIRB-M ¹	EM3B	WIE5
		EAIRB-S	EM3A	WIE5D
		BLT	EM3D	Schuko-1.5m
		TW		Schuko-3.0m
		BLT TW		
		COR		
		COR1min		
		COR30min		

1 Ingress protection IP20

AVAILABLE ACCESSORIES:



Product: Recessed MTG FRAME
S626x626 RAL9003S
Description: Frame for LED luminaire
595x595mm installation into plasterboard
ceiling (1pc), white steel

DPRZ LT80

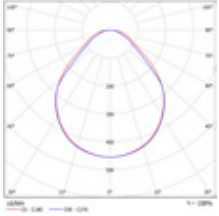



WING D LED

Recessed Luminaires



- DESCRIPTION:** Recessed mounted LED luminaire
Light distribution: direct/indirect
Optical system: translucent micro-prismatic PMMA diffuser
Housing: steel
Colour: white, RAL9003
-
- GENERAL DATA:** **Mains voltage:** 220-240V, 0/50-60Hz
LED lifetime, h: 100000/L80B10
SDCM: 3
Protection class IEC: I
Ingress protection code: IP40/20
Mechanical impact resistance: IK05
Operating temperature range, °C: ta 0...+35
-
- INSTALLATION:** In modular suspended ceilings (600), in ceilings with cut-out openings (mounting frame to be ordered separately). Push-in terminal, 3x2x2.5mm²
-
- ENVIRONMENT:** Indoor
-
- APPLICATION:** Office, education, corridor, retail, public place



PRODUCT	LENGTH, mm	WIDTH, mm	HEIGHT, mm	LUMINAIRE OUTPUT*, lm	SYSTEM POWER*, W	SYSTEM EFFICACY*, lm/W	CRI	CCT*, K	WEIGHT, kg
Wing D LED2x1750 G362 T840 MPRZ LT92	595	595	96	3419	24,5	140	80+	4000	3,6
Wing D LED2x2350 G363 T840 MPRZ LT92	595	595	96	4678	34,5	136	80+	4000	3,6

*Tolerance range for optical and electrical data: ±10%. Values apply to an ambient temperature of 25°C. NORTHCLIFFE LIGHTING is constantly developing and improving its products. The right is reserved to change any product specifications without prior notification

OPTIONS AVAILABLE ON REQUEST:

LED	REFLECTOR AND OPTICS	CONTROL GEAR	EMERGENCY	CONNECTION	COLOUR
T830	MPRZ LT92	DALI	EM3	WIE3	RAL
T840	OP TP(a)	BLT	EM3B	WIE5	
		TW	EM3A	WIE5D	
		BLT TW	EM3D	Schuko-1.5m	
		COR		Schuko-3.0m	
		COR1min			
		COR30min			

AVAILABLE ACCESSORIES:



Product: Recessed MTG FRAME S626x626 RAL9003S
Description: Frame for LED luminaire 595x595mm installation into plasterboard ceiling (1pcs), white steel

STANDARD

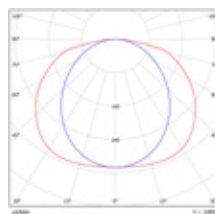

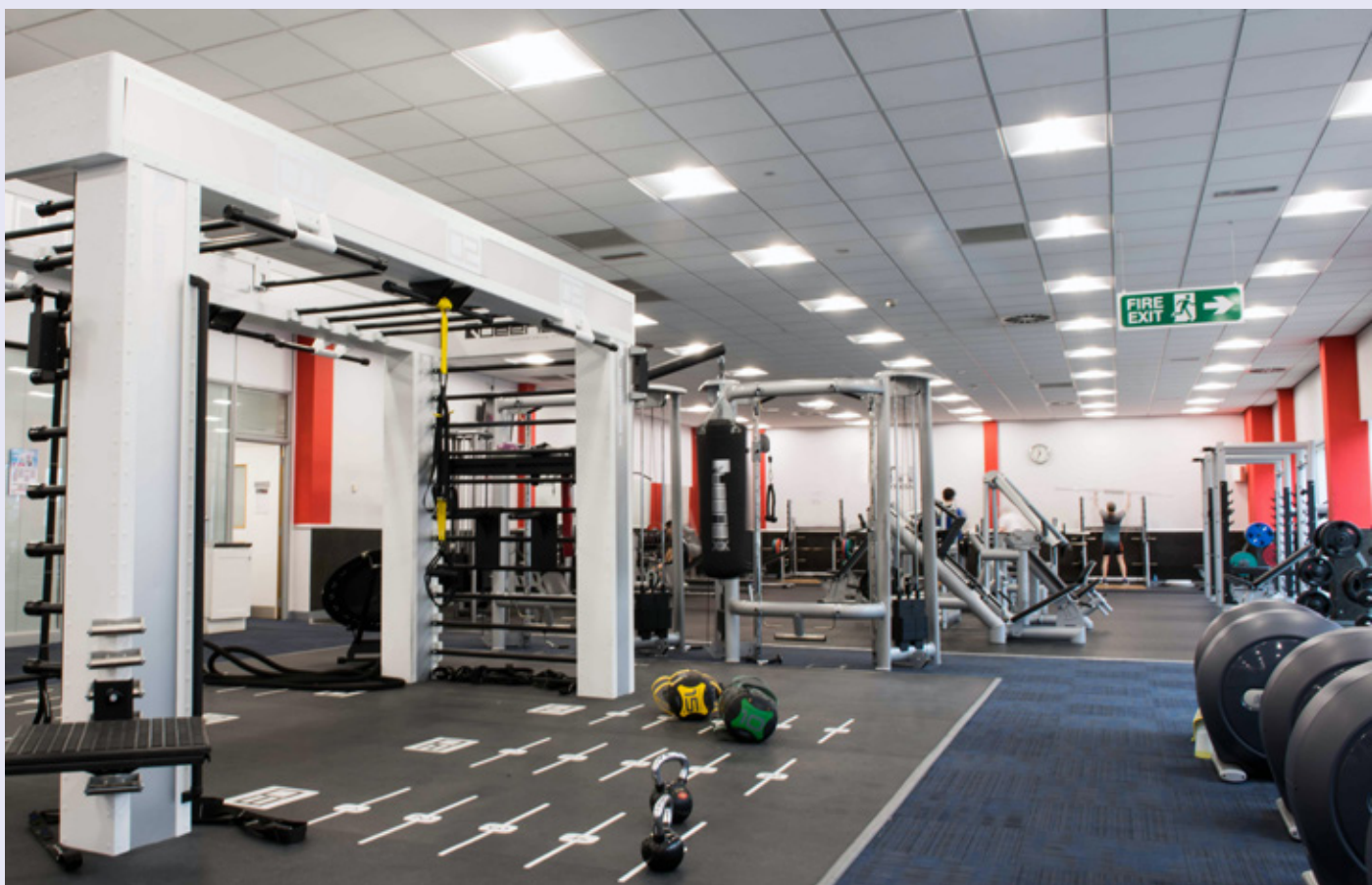

JETTA R LED

Recessed Luminaires



DESCRIPTION: **Recessed mounted LED luminaire**
Light distribution type: indirect
Optical system: white perforated steel louver with soft light distribution, opal polycarbonate film
Housing: steel
Colour: white, RAL9003

GENERAL DATA: **Mains voltage:** 220-240V, 0/50-60Hz
LED lifetime, h: 100000/L80B10
SDCM: 3
Protection class IEC: I
Ingress protection code: IP20
Mechanical impact resistance: IK02
Operating temperature range, °C: ta 0...+35

INSTALLATION: In modular suspended ceilings (600), in ceilings with cut-out openings (mounting frame to be ordered separately). Push-in terminal, 3x2x2.5mm²

ENVIRONMENT: Indoor

APPLICATION: Office, education, corridor, retail, public place

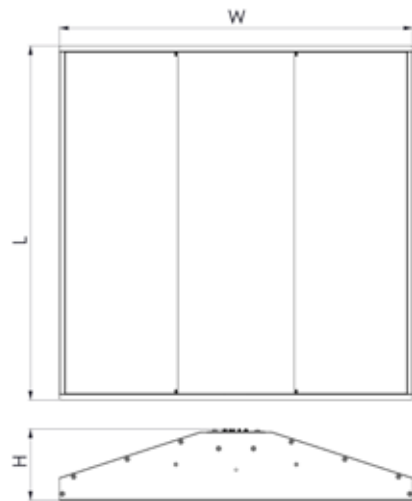

PRODUCT	LENGTH, mm	WIDTH, mm	HEIGHT, mm	LUMINAIRE OUTPUT*, lm	SYSTEM POWER*, W	SYSTEM EFFICACY*, lm/W	CRI	CCT*, K	WEIGHT, kg
Jetta R LED1x2900 G359 T840	595	595	125	2895	26,5	109	80+	4000	3,8
Jetta R LED1x3700 G360 T840	595	595	125	3658	34,5	106	80+	4000	3,8
Jetta R LED1x4200 G361 T840	595	595	125	4194	41,0	102	80+	4000	3,8

*Tolerance range for optical and electrical data: ±10%. Values apply to an ambient temperature of 25°C. NORTHCLIFFE LIGHTING is constantly developing and improving its products. The right is reserved to change any product specifications without prior notification

OPTIONS AVAILABLE ON REQUEST:

LED	CONTROL GEAR	EMERGENCY	CONNECTION
T830	DALI	EM3	WIE3
T840	BLT	EM3B	WIE5
	COR	EM3A	WIE5D
	COR1min	EM3D	Schuko-1.5m
	COR30min		Schuko-3.0m

AVAILABLE ACCESSORIES:



Product: Recessed MTG FRAME S626x626 RAL9003S
Description: Frame for LED luminaire 595x595mm installation into plasterboard ceiling (1pcs), white steel

STANDARD

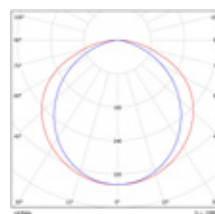





CORONA C LED

Recessed Luminaires



DESCRIPTION: Recessed mounted decorative LED luminaire
Light distribution type: direct
Optical system: opal PMMA diffuser
Housing: steel
Colour: white, RAL9003

GENERAL DATA: **Mains voltage:** 220-240V, 50-60Hz
LED lifetime, h: 50000/L80B10
SDCM: 3
Protection class IEC: I
Ingress protection code: IP40/20
Mechanical impact resistance: IK05
Operating temperature range, °C: ta 0...+35

INSTALLATION: In modular suspended ceilings (600), in ceilings with cut-out openings (mounting frame to be ordered separately). Push-in terminal, 3x2x2.5mm²

ENVIRONMENT: Indoor

APPLICATION: Office, education, corridor, retail, public place

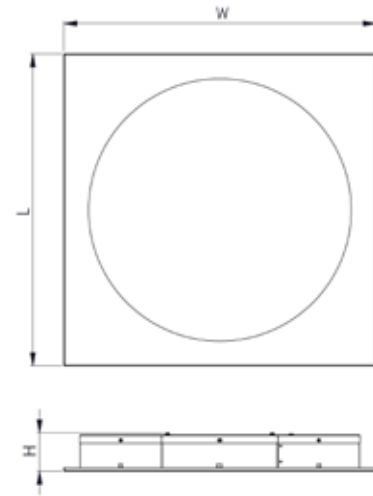

PRODUCT	LENGTH, mm	WIDTH, mm	HEIGHT, mm	LUMINAIRE OUTPUT*, lm	SYSTEM POWER*, W	SYSTEM EFFICACY*, lm/W	CRI	CCT*, K	WEIGHT, kg
Corona C LED1x3600 J496 T840 OP LT80	595	595	100	3564	25,5	140	80+	4000	3,1
Corona C LED1x4450 J497 T840 OP LT80	595	595	100	4419	32,3	137	80+	4000	3,1
Corona C LED1x6050 J498 T840 OP LT80	595	595	100	6022	45,6	132	80+	4000	3,1
Corona C LED1x6850 J499 T840 OP LT80	595	595	100	6817	52,7	129	80+	4000	3,1

*Tolerance range for optical and electrical data: ±10%. Values apply to an ambient temperature of 25°C. NORTHCLIFFE LIGHTING is constantly developing and improving its products. The right is reserved to change any product specifications without prior notification

OPTIONS AVAILABLE ON REQUEST:

LED	REFLECTOR AND OPTICS	CONTROL GEAR	EMERGENCY	CONNECTION	OTHER	COLOUR
T830	DPRZ LT80	DALI	EM3	WIE3-0.5m	W625	RAL
T840	OP LT80	EAIRB-M ^{1 2 3}	EM3B	WIE5D-0.5m		
	OP TP(a)	EAIRB-S ^{2 3}	EM3A	Schuko-1.5m		
		BLT	EM3D	Schuko-3.0m		
		COR				
		COR1min				
		COR30min				

1 Ingress protection IP20
 2 Max system size 1x EAIRB-M + 3x EAIRB-S
 3 Max wire length from EAIRB-M to last EAIRB-S - 11 m

AVAILABLE ACCESSORIES:



Product: Recessed MTG FRAME
S626x626 RAL9003S
Description: Frame for LED luminaire
595x595mm installation into plasterboard
ceiling (1pcs), white steel

OP LT80

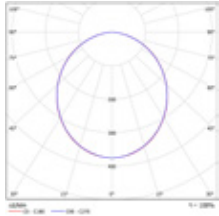

DPRZ LT80

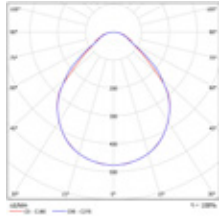

CORONA Q LED

Recessed Luminaires

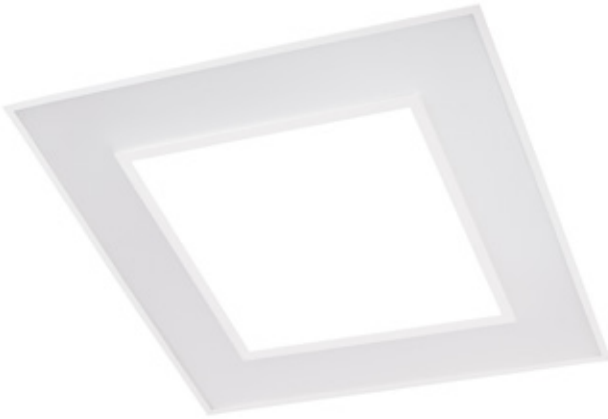

DESCRIPTION: **Recessed mounted LED luminaire**
Light distribution type: direct
Optical system: matt micro-prismatic PMMA diffuser, low glare / translucent micro-prismatic PMMA diffuser
Housing: steel
Colour: white, RAL9003S

GENERAL DATA: **Mains voltage:** 220-240V, 50-60Hz
LED lifetime, h: 50000/L80B10
SDCM: 3
Protection class IEC: I
Ingress protection code: IP44
Mechanical impact resistance: IK05
Operating temperature range, °C: ta 0...+35

INSTALLATION: In modular suspended ceilings, in ceilings with cut-out openings (mounting frame to be ordered separately). Push-in terminal, 3x2x2.5mm²

ENVIRONMENT: Indoor

APPLICATION: Office, education, corridor, retail, public place

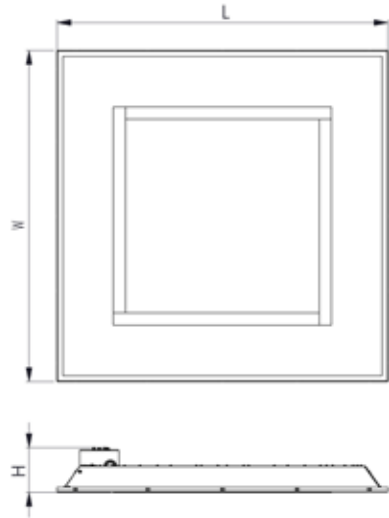

PRODUCT	LENGTH, mm	WIDTH, mm	HEIGHT, mm	LUMINAIRE OUTPUT*, lm	SYSTEM POWER*, W	SYSTEM EFFICACY*, lm/W	CRI	CCT*, K	WEIGHT, kg
Corona Q LED1x2350 J229 T840 DPRZ LT80	595	595	82	2326	17,1	136	80+	4000	3,0
Corona Q LED1x2900 J230 T840 DPRZ LT80	595	595	82	2884	21,2	136	80+	4000	3,0
Corona Q LED1x3450 J231 T840 DPRZ LT80	595	595	82	3430	25,4	135	80+	4000	3,0
Corona Q LED1x3950 J232 T840 DPRZ LT80	595	595	82	3929	29,7	132	80+	4000	3,0
Corona Q LED1x4950 J233 T840 DPRZ LT80	595	595	82	4910	38,9	126	80+	4000	3,0
Corona Q LED1x2600 J229 T840 MPRZ LT92	595	595	82	2584	17,1	151	80+	4000	3,0
Corona Q LED1x3250 J230 T840 MPRZ LT92	595	595	82	3204	21,2	151	80+	4000	3,0
Corona Q LED1x3850 J231 T840 MPRZ LT92	595	595	82	3811	25,4	150	80+	4000	3,0
Corona Q LED1x4400 J232 T840 MPRZ LT92	595	595	82	4366	29,7	147	80+	4000	3,0
Corona Q LED1x5500 J233 T840 MPRZ LT92	595	595	82	5456	38,9	140	80+	4000	3,0

*Tolerance range for optical and electrical data: ±10%. Values apply to an ambient temperature of 25°C. NORTHCLIFFE LIGHTING is constantly developing and improving its products. The right is reserved to change any product specifications without prior notification

OPTIONS AVAILABLE ON REQUEST:

LED	REFLECTOR AND OPTICS	CONTROL GEAR	SENSORS	EMERGENCY	CONNECTION	OTHER	COLOUR
T830	DPRZ LT80	DALI	PIR ⁵	EM3	WIE3	INSERT	RAL
T840	MPRZ LT92	EAIRB-M ^{1 2 3 4}		EM3B	WIE5		
		OP TP(a)	EAIRB-S ^{3 4}	EM3A	WIE5D		
		BLT	EM3D	2WIE3			
		COR			Schuko-1.5m		
		COR1min			Schuko-3.0m		
	COR30min						

- 1 EAIRB-M option is only available with option INSERT
- 2 For option EAIRB-M ingress protection IP20
- 3 Max system size 1x EAIRB-M + 3x EAIRB-S
- 4 Max wire length from EAIRB-M to last EAIRB-S - 11 m
- 5 PIR option is only available with option INSERT

INSERT option



DPRZ LT80

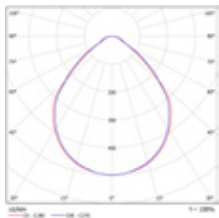

MPRZ LT92

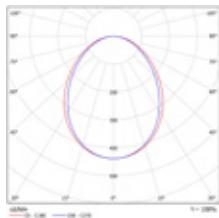

LINE U LED

Recessed Luminaires



DESCRIPTION: **Recessed mounted LED luminaire**
Light distribution type: direct
Optical system: double parabolic reflector with lenses, low glare
Housing: steel
Colour: white, RAL9003S

GENERAL DATA: **Mains voltage:** 220-240V, 0/50-60Hz
LED lifetime, h: 100000/L80B10
SDCM: 3
Protection class IEC: I
Ingress protection code: IP40
Mechanical impact resistance: IK05
Operating temperature range, °C: ta 0...+35

INSTALLATION: In modular suspended ceilings. Luminaire from two parts and single gearbox can be installed into every next tile, or optionally into every fourth tile. Push-in terminal, 3x2x2.5mm²

ENVIRONMENT: Indoor

APPLICATION: Office, education, corridor, retail, public place

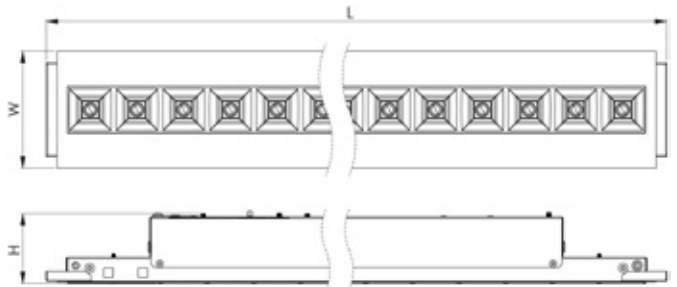

PRODUCT	LENGTH, mm	WIDTH, mm	HEIGHT, mm	LUMINAIRE OUTPUT*, lm	SYSTEM POWER*, W	SYSTEM EFFICACY*, lm/W	CRI	CCT*, K	WEIGHT, kg
Line U LED1x1500 J234 T840 WGC	595	100	61	1460	9,6	152	80+	4000	1,0
Line U LED1x1800 J235 T840 WGC	595	100	61	1792	11,3	159	80+	4000	1,0
Line U LED1x2150 J236 T840 WGC	595	100	61	2111	13,9	152	80+	4000	1,0
Line U LED1x2450 J237 T840 WGC	595	100	61	2433	16,4	148	80+	4000	1,0
Line U LED2x1x1500 J238 T840 WGC	2x595	100	61	2920	17,6	166	80+	4000	2,0
Line U LED2x1x1800 J239 T840 WGC	2x595	100	61	3583	21,9	164	80+	4000	2,0
Line U LED2x1x2150 J240 T840 WGC	2x595	100	61	4222	26,7	158	80+	4000	2,0
Line U LED2x1x2450 J241 T840 WGC	2x595	100	61	4867	30,4	160	80+	4000	2,0
Line U LED1x2950 J242 T840 WGC	1195	100	61	2920	17,6	166	80+	4000	1,8
Line U LED1x3600 J243 T840 WGC	1195	100	61	3583	21,9	164	80+	4000	1,8
Line U LED1x4250 J244 T840 WGC	1195	100	61	4222	26,7	158	80+	4000	1,8
Line U LED1x4900 J245 T840 WGC	1195	100	61	4867	30,4	160	80+	4000	1,8
Line U LED1x1350 J234 T840 BGC	595	100	61	1347	9,6	140	80+	4000	1,0
Line U LED1x1700 J235 T840 BGC	595	100	61	1654	11,3	146	80+	4000	1,0
Line U LED1x1950 J236 T840 BGC	595	100	61	1949	13,9	140	80+	4000	1,0
Line U LED1x2250 J237 T840 BGC	595	100	61	2246	16,4	137	80+	4000	1,0
Line U LED2x1x1350 J238 T840 BGC	2x595	100	61	2696	17,6	153	80+	4000	2,0
Line U LED2x1x1700 J239 T840 BGC	2x595	100	61	3307	21,9	151	80+	4000	2,0
Line U LED2x1x1950 J240 T840 BGC	2x595	100	61	3898	26,7	146	80+	4000	2,0
Line U LED2x1x2250 J241 T840 BGC	2x595	100	61	4492	30,4	148	80+	4000	2,0

PRODUCT	LENGTH, mm	WIDTH, mm	HEIGHT, mm	LUMINAIRE OUTPUT*, lm	SYSTEM POWER*, W	SYSTEM EFFICACY*, lm/W	CRI	CCT*, K	WEIGHT, kg
Line U LED1x2700 J242 T840 BGC	1195	100	61	2696	17,6	153	80+	4000	1,8
Line U LED1x3350 J243 T840 BGC	1195	100	61	3307	21,9	151	80+	4000	1,8
Line U LED1x3900 J244 T840 BGC	1195	100	61	3898	26,7	146	80+	4000	1,8
Line U LED1x4500 J245 T840 BGC	1195	100	61	4492	30,4	148	80+	4000	1,8

*Tolerance range for optical and electrical data: ±10%. Values apply to an ambient temperature of 25°C. NORTHCLIFFE LIGHTING is constantly developing and improving its products. The right is reserved to change any product specifications without prior notification

OPTIONS AVAILABLE ON REQUEST:

LED	REFLECTOR AND OPTICS	CONTROL GEAR	EMERGENCY	CONNECTION	COLOUR
T830	WGC	DALI	EM3	WIE3-0.5m	RAL
T840	BGC	EAIRB-S ¹ 2	EM3B	WIE5D-0.5m	
	WMC	BLT	EM3A	Schuko-1.5m	
	BMC	COR	EM3D	Schuko-3.0m	
	MGC	COR1min		CONCB/4 ³	
	MMC	COR30min			
WAC/BAC					

- 1 Max system size 1x EAIRB-M + 3x EAIRB-S
- 2 Max wire length from EAIRB-M to last EAIRB-S - 11 m
- 3 CONCB/4 option is only available for models: J238; J239; J240; J241

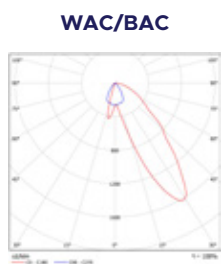
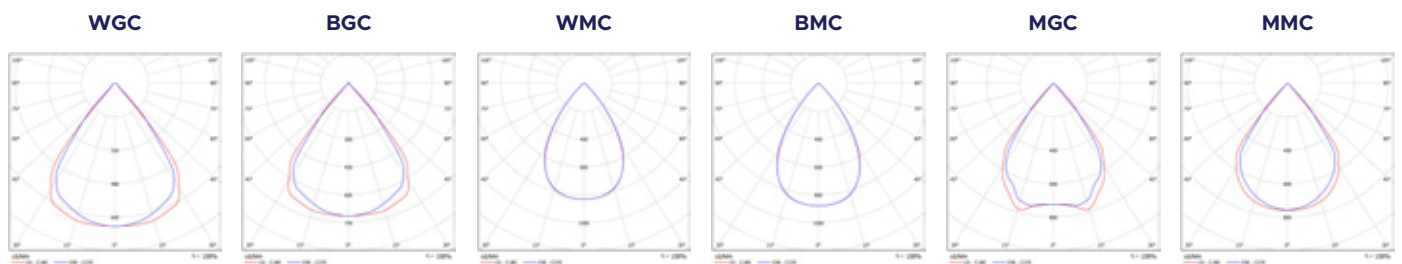



LINE R LED

Recessed Luminaires

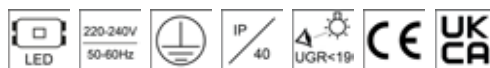

DESCRIPTION: Recessed mounted linear LED luminaire/
Recessed mounted linear LED luminaire from two parts

Light distribution type: direct
Optical system: matt micro-prismatic PMMA diffuser, low glare / translucent micro-prismatic PMMA diffuser
Housing: steel
Colour: white, RAL9003

GENERAL DATA: **G range mains voltage:** 220-240V, 50-60Hz, basic version: 220-240V, 0/50-60Hz
LED lifetime, h: 100000/L80B10, basic version: 50000/L80B10
SDCM: 3
Protection class IEC: I
Ingress protection code: IP40/20
Mechanical impact resistance: IK02
Operating temperature range, °C: ta 0...+35

INSTALLATION: In modular suspended ceilings. Luminaire from two parts and single gearbox can be installed into every next tile, or optionally into every fourth tile. Push-in terminal, 3x2x2.5mm²

ENVIRONMENT: Indoor

APPLICATION: Office, education, corridor, retail, public place

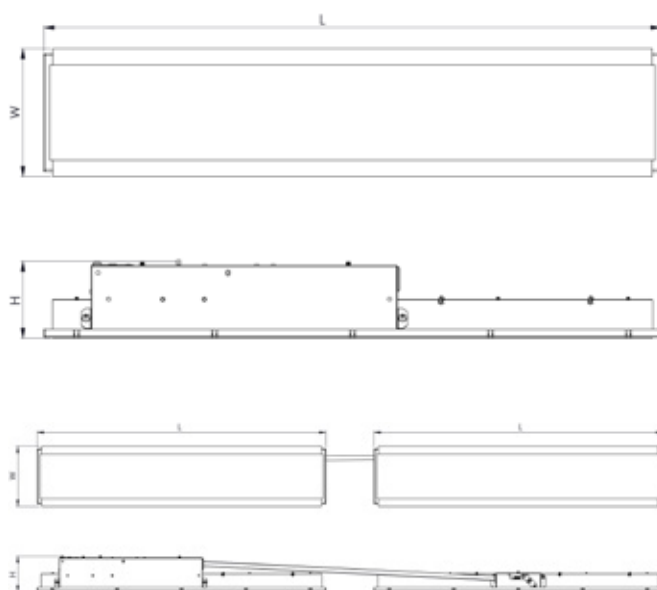

PRODUCT	LENGTH, mm	WIDTH, mm	HEIGHT, mm	LUMINAIRE OUTPUT*, lm	SYSTEM POWER*, W	SYSTEM EFFICACY*, lm/W	CRI	CCT*, K	WEIGHT, kg
Line R LED 2x1x1950 G920 T840 DPRZ LT80 LO1	2x595	123	72	3986	25,9	154	80+	4000	2,6
Line R LED 2x1x2700 G921 T840 DPRZ LT80 LO2	2x595	123	72	5523	37,6	147	80+	4000	2,6
Line R LED 1x1950 G922 T840 DPRZ LT80 LO1	595	123	72	1993	13,7	145	80+	4000	1,7
Line R LED 1x2700 G923 T840 DPRZ LT80 LO2	595	123	72	2761	18,8	147	80+	4000	1,7
Line R LED 1x3850 G924 T840 DPRZ LT80 LO1	1195	123	72	3986	25,9	154	80+	4000	2,4
Line R LED 1x5350 G925 T840 DPRZ LT80 LO2	1195	123	72	5523	37,6	147	80+	4000	2,4
Line R LED 2x1x2150 G920 T840 MPRZ LT92 LO1	2x595	123	72	4319	25,9	167	80+	4000	2,6
Line R LED 2x1x3000 G921 T840 MPRZ LT92 LO2	2x595	123	72	5983	37,6	159	80+	4000	2,6
Line R LED 1x2150 G922 T840 MPRZ LT92 LO1	595	123	72	2159	13,7	158	80+	4000	1,7
Line R LED 1x3000 G923 T840 MPRZ LT92 LO2	595	123	72	2992	18,8	159	80+	4000	1,7
Line R LED 1x4300 G924 T840 MPRZ LT92 LO1	1195	123	72	4319	25,9	167	80+	4000	2,4
Line R LED 1x5950 G925 T840 MPRZ LT92 LO2	1195	123	72	5983	37,6	159	80+	4000	2,4

PRODUCT Basic version	LENGTH, mm	WIDTH, mm	HEIGHT, mm	LUMINAIRE OUTPUT*, lm	SYSTEM POWER*, W	SYSTEM EFFICACY*, lm/W	CRI	CCT*, K	WEIGHT, kg
Line R LED 2x1x1700 H226 T840 DPRZ LT80 LO1	2x595	123	72	3493	26,9	130	80+	4000	2,6
Line R LED 2x1x2350 H213 T840 DPRZ LT80 LO2	2x595	123	72	4801	38,2	126	80+	4000	2,6
Line R LED 1x1700 H214 T840 DPRZ LT80 LO1	595	123	72	1746	13,9	126	80+	4000	1,7
Line R LED 1x2350 H215 T840 DPRZ LT80 LO2	595	123	72	2401	20,0	120	80+	4000	1,7
Line R LED 1x3400 H216 T840 DPRZ LT80 LO1	1195	123	72	3493	26,9	130	80+	4000	2,4
Line R LED 1x4650 H217 T840 DPRZ LT80 LO2	1195	123	72	4801	38,2	126	80+	4000	2,4
Line R LED 2x1x1900 H226 T840 MPRZ LT92 LO1	2x595	123	72	3784	26,9	141	80+	4000	2,6
Line R LED 2x1x2600 H213 T840 MPRZ LT92 LO2	2x595	123	72	5201	38,2	136	80+	4000	2,6
Line R LED 1x1900 H214 T840 MPRZ LT92 LO1	595	123	72	1892	13,9	136	80+	4000	1,7
Line R LED 1x2600 H215 T840 MPRZ LT92 LO2	595	123	72	2601	20,0	130	80+	4000	1,7
Line R LED 1x3750 H216 T840 MPRZ LT92 LO1	1195	123	72	3784	26,9	141	80+	4000	2,4
Line R LED 1x5150 H217 T840 MPRZ LT92 LO2	1195	123	72	5201	38,2	136	80+	4000	2,4

*Tolerance range for optical and electrical data: ±10%. Values apply to an ambient temperature of 25°C. NORTHCLIFFE LIGHTING is constantly developing and improving its products. The right is reserved to change any product specifications without prior notification

OPTIONS AVAILABLE ON REQUEST:

LED	REFLECTOR AND OPTICS	CONTROL GEAR	EMERGENCY	CONNECTION	OTHER
T830	DPRZ LT80	DALI	EM3	WIE3-0.5m	W625*
T840	MPRZ LT92	EAIRB-M* 1 2 3 4	EM3B	WIE5D-0.5m	
	OP TP(a)	EAIRB-S* 2 3 4	EM3A	Schuko-1.5m	
		BLT*	EM3D	Schuko-3.0m	
		TW*		CONCB/4 ⁵	
		BLT TW*			
		COR*			
		COR1min*			
		COR30min*			

- 1 Ingress protection IP20
- 2 Max system size 1x EAIRB-M + 3x EAIRB-S
- 3 Max wire length from EAIRB-M to last EAIRB-S - 11 m
- 4 EAIRB option not applicable for models: G922
- 5 CONCB/4 option is only available for models: G920; G921; H226; H213
- * Not applicable for basic version

DPRZ LT80

MPRZ LT92

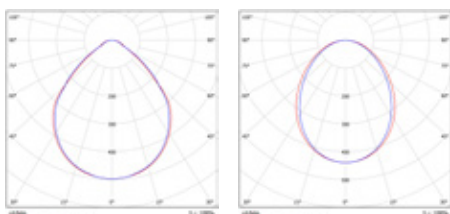

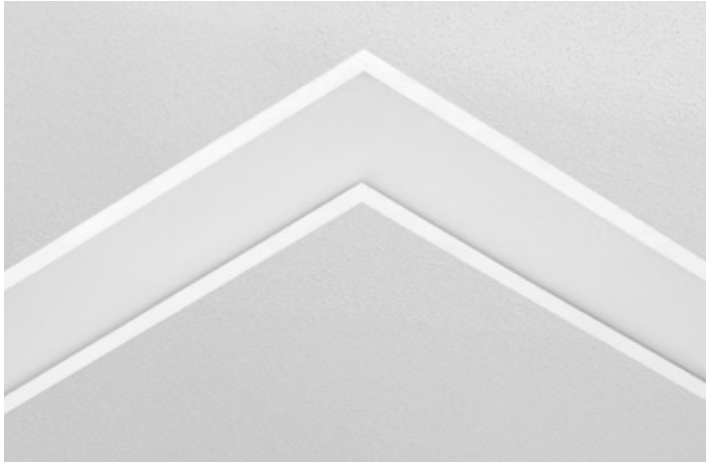

LINE R LED CORNER90

Recessed Luminaires



DESCRIPTION: **Recessed mounted linear LED luminaire**
Light distribution type: direct
Optical system: matt micro-prismatic PMMA diffuser, low glare / translucent micro-prismatic PMMA diffuser
Housing: steel
Colour: white, RAL9003

GENERAL DATA: **Mains voltage:** 220-240V, 0/50-60Hz
G range LED lifetime, h: 100000/L80B10, basic version: 50000/L80B10
SDCM: 3
Protection class IEC: I
Ingress protection code: IP40/20
Mechanical impact resistance: IK02
Operating temperature range, °C: ta 0...+35

INSTALLATION: In modular suspended ceilings. Push-in terminal, 3x2x2.5mm²

ENVIRONMENT: Indoor

APPLICATION: Office, education, corridor, retail, public place

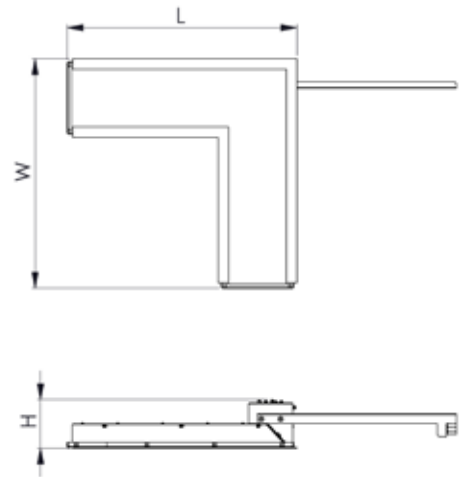

PRODUCT	LENGTH, mm	WIDTH, mm	HEIGHT, mm	LUMINAIRE OUTPUT*, lm	SYSTEM POWER*, W	SYSTEM EFFICACY*, lm/W	CRI	CCT*, K	WEIGHT, kg
Line R LED1x2000 G936 T840 DPRZ LT80 LO1 CORNER90	358	358	70	1993	13,8	144	80+	4000	1,2
Line R LED1x2800 G937 T840 DPRZ LT80 LO2 CORNER90	358	358	70	2761	18,8	147	80+	4000	1,2
Line R LED1x2200 G936 T840 MPRZ LT92 LO1 CORNER90	358	358	70	2159	13,8	156	80+	4000	1,2
Line R LED1x3000 G937 T840 MPRZ LT92 LO2 CORNER90	358	358	70	2992	18,8	159	80+	4000	1,2
Basic version									
Line R LED1x1750 H218 T840 DPRZ LT80 LO1 CORNER90	358	358	70	1746	13,9	126	80+	4000	1,2
Line R LED1x2450 H219 T840 DPRZ LT80 LO2 CORNER90	358	358	70	2401	20,0	120	80+	4000	1,2
Line R LED1x1900 H218 T840 MPRZ LT92 LO1 CORNER90	358	358	70	1892	13,9	136	80+	4000	1,2
Line R LED1x2650 H219 T840 MPRZ LT92 LO2 CORNER90	358	358	70	2601	20,0	130	80+	4000	1,2

*Tolerance range for optical and electrical data: ±10%. Values apply to an ambient temperature of 25°C. NORTHCLIFFE LIGHTING is constantly developing and improving its products. The right is reserved to change any product specifications without prior notification

OPTIONS AVAILABLE ON REQUEST:

LED	REFLECTOR AND OPTICS	CONTROL GEAR	CONNECTION
T830	DPRZ LT80	DALI	WIE3-0.5m
T840	MPRZ LT92	EAIRB-S* ¹	WIE5D-0.5m
	OP TP(a)	BLT* ²	Schuko-1.5m
		TW* ²	Schuko-3.0m
		BLT TW* ²	
		COR	
		COR1min	
		COR30min	

¹ Ask for special model with option EAIRB-S

² Ask for special model with option TW

* Not applicable for basic version

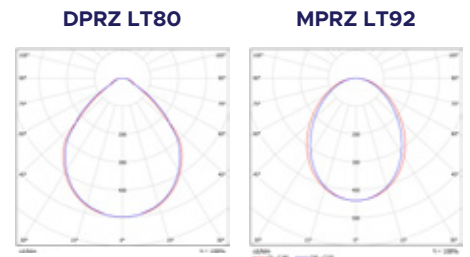

Combination of Line R LED and Line CORNER90 LED luminaires enables to create different patterns and animate working environment

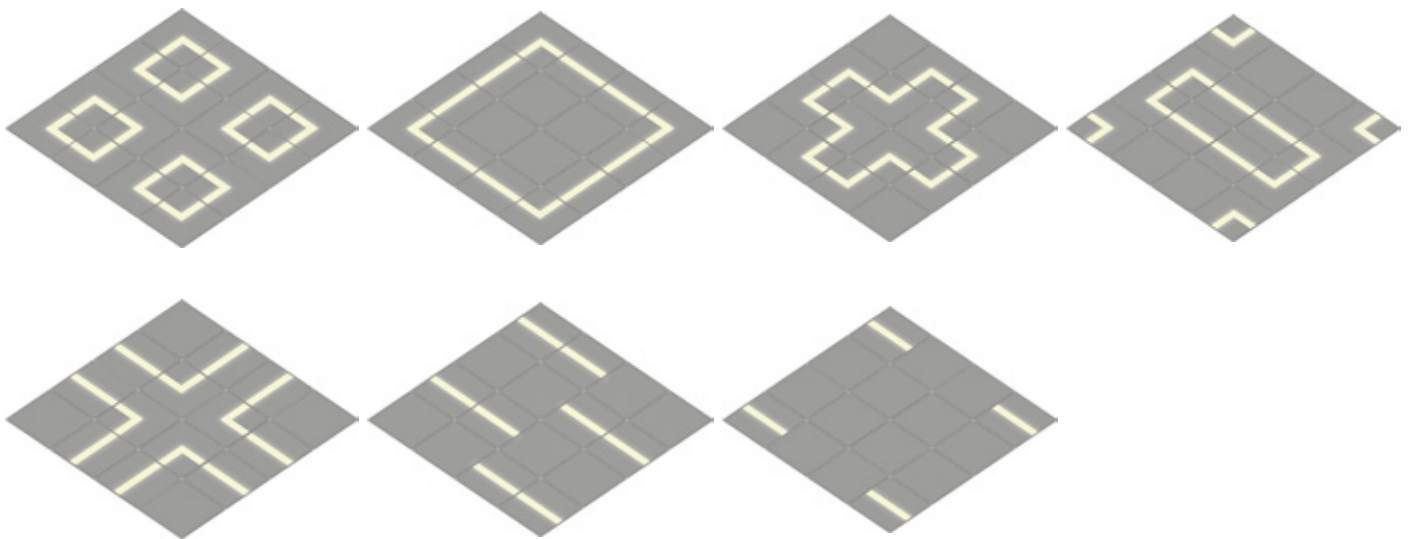

RANA LED

Recessed Luminaires

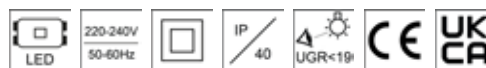

DESCRIPTION: **Recessed mounted round LED panel**
Light distribution type: direct
Optical system: opal diffuser / micro-prismatic diffuser, low glare
Housing: aluminum
Colour: white, RAL9016

GENERAL DATA: **Mains voltage:** 220-240V, 50-60Hz
LED lifetime, h: 50000/L80B20
SDCM: 3
Protection class IEC: II
Ingress protection code: IP40
Mechanical impact resistance: IK02
Operating temperature range, °C: ta 0...+40

INSTALLATION: In ceilings with cut-out openings. Push-in terminal, 2x1x1.5mm²

ENVIRONMENT: Indoor

APPLICATION: Office, education, corridor, retail, public place

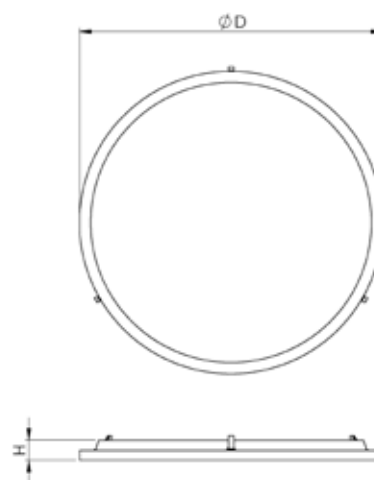

PRODUCT	DIAMETER, mm	HEIGHT, mm	CUT-OUT, mm	LUMINAIRE OUTPUT*, lm	SYSTEM POWER*, W	SYSTEM EFFICACY*, lm/W	CRI	CCT*, K	WEIGHT, kg
Rana LED1x1800 J829 T830/40 OP	300	38	272	1755	13,5	130	80+	3000/4000	0,7
Rana LED1x2500 J830 T830/40 OP	300	38	272	2470	19,0	130	80+	3000/4000	0,7
Rana LED1x2550 J831 T830/40 OP	500	38	472	2522	19,4	130	80+	3000/4000	1,8
Rana LED1x3650 J832 T830/40 OP	500	38	472	3640	28,0	130	80+	3000/4000	1,8
Rana LED1x4550 J833 T830/40 OP	500	38	472	4550	35,0	130	80+	3000/4000	1,8
Rana LED1x1650 J829 T830/40 DPRZ	300	38	272	1620	13,5	120	80+	3000/4000	0,7
Rana LED1x2300 J830 T830/40 DPRZ	300	38	272	2280	19,0	120	80+	3000/4000	0,7
Rana LED1x2350 J831 T830/40 DPRZ	500	38	472	2328	19,4	120	80+	3000/4000	1,8
Rana LED1x3400 J832 T830/40 DPRZ	500	38	472	3360	28,0	120	80+	3000/4000	1,8
Rana LED1x4200 J833 T830/40 DPRZ	500	38	472	4200	35,0	120	80+	3000/4000	1,8

*Tolerance range for optical and electrical data: ±10%. Values apply to an ambient temperature of 25°C. NORTHCLIFFE LIGHTING is constantly developing and improving its products. The right is reserved to change any product specifications without prior notification

AVAILABLE ACCESSORIES:



Product: Decorative COVER 595x595/D451 Rana LED RAL9016
Description: Decorative cover with 451mm round opening for LED panel 595x595mm (1pcs), white steel

Product: Decorative COVER 625x625/D451 Rana LED RAL9016
Description: Decorative cover with 451mm round opening for LED panel 625x625mm (1pcs), white steel

OPTIONS AVAILABLE ON REQUEST:

LED	REFLECTOR AND OPTICS	CONTROL GEAR	EMERGENCY	CONNECTION
T830/40	OP	DALI	EM3	QBX2-0.1m
	DPRZ	DALI LOOP	EM3B	Europlug-1.5m
		COR	EM3A	Europlug-3.0m
		COR1min	EM3D	WIE3-0.5m
		COR30min		WIE5D-0.5m

OP

DPRZ

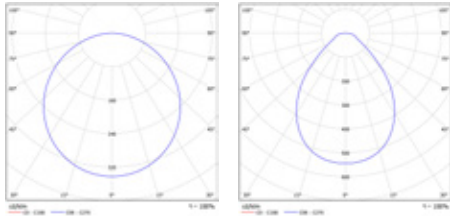

LYRA R LED

Recessed Luminaires



DESCRIPTION: Recessed mounted LED luminaire
Light distribution type: direct
Optical system: opal PMMA diffuser
Housing: steel
Colour: white, RAL9003

GENERAL DATA: Mains voltage: 220-240V, 0/50-60Hz
LED lifetime, h: 50000/L80B10
SDCM: 3
Protection class IEC: I
Ingress protection code: IP20
Operating temperature range, °C: ta 0...+35

INSTALLATION: In ceilings with cut-out openings (mounting brackets included). Push-in terminal, 3x2x2.5mm²

ENVIRONMENT: Indoor

APPLICATION: Office, education, corridor, retail, public place

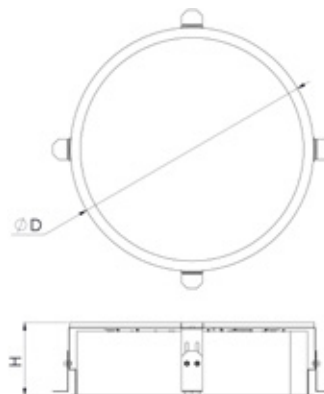

PRODUCT	DIAMETER, mm	HEIGHT, mm	CUT-OUT, mm	LUMINAIRE OUTPUT*, lm	SYSTEM POWER*, W	SYSTEM EFFICACY*, lm/W	CRI	CCT*, K	WEIGHT, kg
Lyra R LED1x1800 D083 T840 OP LT80	326	143	310	1764	15,7	112	80+	4000	4,0
Lyra R LED1x2450 D084 T840 OP LT80	326	143	310	2424	23,0	105	80+	4000	4,0
Lyra R LED1x3600 D085 T840 OP LT80	476	143	460	3566	31,7	112	80+	4000	6,8
Lyra R LED1x4150 D086 T840 OP LT80	476	143	460	4121	37,7	109	80+	4000	6,8
Lyra R LED1x5300 D087 T840 OP LT80	624	153	610	5291	46,5	114	80+	4000	10,0
Lyra R LED1x7300 D088 T840 OP LT80	624	153	610	7273	66,6	109	80+	4000	10,0
Lyra R LED1x8850 D089 T840 OP LT80	922	153	910	8835	81,7	108	80+	4000	14,0
Lyra R LED1x11700 D090 T840 OP LT80	922	153	910	11657	110,4	106	80+	4000	14,0

*Tolerance range for optical and electrical data: ±10%. Values apply to an ambient temperature of 25°C. NORTHCLIFFE LIGHTING is constantly developing and improving its products. The right is reserved to change any product specifications without prior notification

OPTIONS AVAILABLE ON REQUEST:

LED	REFLECTOR AND OPTICS	CONTROL GEAR	SENSORS	EMERGENCY	COLOUR
T830	OP LT80	DALI	MW	EM3	RAL
T840	OP TP(α)	BLT		EM3B	
				EM3A	
				EM3D	

OP LT80

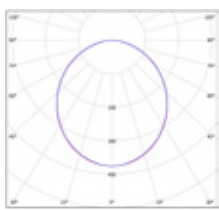

BALI C LED

Recessed Luminaires

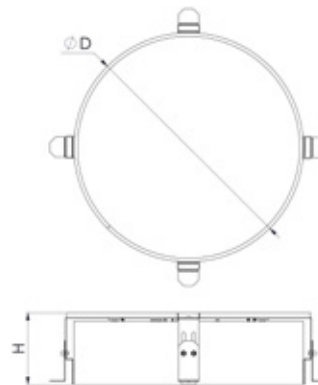

DESCRIPTION: Recessed plaster-in frameless LED luminaire
Light distribution type: direct
Optical system: opal PMMA diffuser
Housing: steel
Colour: white, RAL9003

GENERAL DATA: **Mains voltage:** 220-240V, 50-60Hz
LED lifetime, h: 50000/L80B10
SDCM: 3
Protection class IEC: I
Ingress protection code: IP20
Operating temperature range, °C: ta 0...+35

INSTALLATION: In ceilings with cut-out openings (mounting brackets included). Push-in terminal, 3x2x2.5mm²

ENVIRONMENT: Indoor

APPLICATION: Office, education, corridor, retail, public place

PRODUCT	DIAMETER, mm	HEIGHT, mm	CUT-OUT, mm	LUMINAIRE OUTPUT*, lm	SYSTEM POWER*, W	SYSTEM EFFICACY*, lm/W	CRI	CCT*, K	WEIGHT, kg
Bali C LED1x1800 D103 T840 OP LT80	300	142	305	1764	16,4	108	80+	4000	2,5
Bali C LED1x2450 D104 T840 OP LT80	300	142	305	2424	23,5	103	80+	4000	2,5
Bali C LED1x3600 D105 T840 OP LT80	450	142	455	3566	32,0	111	80+	4000	4,8
Bali C LED1x4150 D106 T840 OP LT80	450	142	455	4121	37,7	109	80+	4000	4,8
Bali C LED1x5300 D107 T840 OP LT80	600	152	605	5291	46,5	114	80+	4000	7,5
Bali C LED1x7300 D108 T840 OP LT80	600	152	605	7273	66,6	109	80+	4000	7,5
Bali C LED1x8850 D109 T840 OP LT80	900	152	905	8835	79,8	111	80+	4000	10,5
Bali C LED1x11700 D110 T840 OP LT80	900	152	905	11657	108,0	108	80+	4000	10,5

*Tolerance range for optical and electrical data: ±10%. Values apply to an ambient temperature of 25°C. NORTHCLIFFE LIGHTING is constantly developing and improving its products. The right is reserved to change any product specifications without prior notification

OPTIONS AVAILABLE ON REQUEST:

LED	REFLECTOR AND OPTICS	CONTROL GEAR	SENSORS	EMERGENCY
T830	OP LT80	DALI	MW	EM3
T840	OP TP(α)	BLT		EM3B
				EM3A
				EM3D

OP LT80

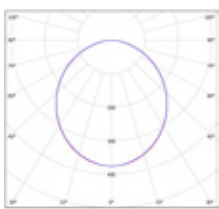

BALI R LED

Recessed Luminaires



DESCRIPTION: Recessed plaster-in frameless LED luminaire
Light distribution type: direct
Optical system: translucent micro-prismatic PMMA diffuser / opal PMMA diffuser
Housing: steel
Colour: white, RAL9003

GENERAL DATA: **Mains voltage:** 220-240V, 50-60Hz
LED lifetime, h: 50000/L80B10
SDCM: 3
Protection class IEC: I
Ingress protection code: IP20
Operating temperature range, °C: ta 0...+35

INSTALLATION: In ceilings with cut-out openings (mounting brackets included). Push-in terminal, 3x2x2.5mm²

ENVIRONMENT: Indoor

APPLICATION: Office, education, corridor, retail, public place



PRODUCT	LENGTH, mm	WIDTH, mm	HEIGHT, mm	CUT-OUT, mm	LUMINAIRE OUTPUT*, lm	SYSTEM POWER*, W	SYSTEM EFFICACY*, lm/W	CRI	CCT*, K	WEIGHT, kg
Bali R LED1x1100 D720 T840 MPRZ LT92	220	220	85	224x224	1109	10,8	103	80+	4000	1,8
Bali R LED1x1550 D721 T840 MPRZ LT92	220	220	85	224x224	1549	14,7	105	80+	4000	1,8
Bali R LED1x1150 D722 T840 MPRZ LT92	595	85	65	599x89	1160	10,1	115	80+	4000	1,8
Bali R LED1x1550 D723 T840 MPRZ LT92	595	85	65	599x89	1580	13,6	116	80+	4000	1,8
Bali R LED1x1700 D724 T840 MPRZ LT92	875	85	65	879x89	1740	14,4	121	80+	4000	2,1
Bali R LED1x2300 D725 T840 MPRZ LT92	875	85	65	879x89	2370	20,5	116	80+	4000	2,1
Bali R LED1x2250 D726 T840 MPRZ LT92	1155	85	65	1159x89	2319	19,1	121	80+	4000	2,4
Bali R LED1x3100 D727 T840 MPRZ LT92	1155	85	65	1159x89	3160	25,8	122	80+	4000	2,4
Bali R LED1x2850 D728 T840 MPRZ LT92	1435	85	65	1439x89	2899	23,9	121	80+	4000	2,8
Bali R LED1x3850 D990 T840 MPRZ LT92	1435	85	65	1439x89	3950	32,1	123	80+	4000	2,8
Bali R LED1x1100 D720 T840 OP LT80	220	220	85	224x224	1080	10,8	100	80+	4000	1,8
Bali R LED1x1550 D721 T840 OP LT80	220	220	85	224x224	1508	14,7	103	80+	4000	1,8
Bali R LED1x1150 D722 T840 OP LT80	595	85	65	599x89	1129	10,1	112	80+	4000	1,8
Bali R LED1x1550 D723 T840 OP LT80	595	85	65	599x89	1538	13,6	113	80+	4000	1,8
Bali R LED1x1700 D724 T840 OP LT80	875	85	65	879x89	1694	14,4	118	80+	4000	2,1
Bali R LED1x2300 D725 T840 OP LT80	875	85	65	879x89	2307	20,5	113	80+	4000	2,1
Bali R LED1x2250 D726 T840 OP LT80	1155	85	65	1159x89	2258	19,1	118	80+	4000	2,4
Bali R LED1x3100 D727 T840 OP LT80	1155	85	65	1159x89	3077	25,8	119	80+	4000	2,4
Bali R LED1x2850 D728 T840 OP LT80	1435	85	65	1439x89	2822	23,9	118	80+	4000	2,8
Bali R LED1x3850 D990 T840 OP LT80	1435	85	65	1439x89	3846	32,1	120	80+	4000	2,8

*Tolerance range for optical and electrical data: ±10%. Values apply to an ambient temperature of 25°C. NORTHCLIFFE LIGHTING is constantly developing and improving its products. The right is reserved to change any product specifications without prior notification

OPTIONS AVAILABLE ON REQUEST:

LED	REFLECTOR AND OPTICS	CONTROL GEAR
T830	MPRZ LT92	DALI
T840	OP LT80	
	OP TP(a)	

MPRZ LT92

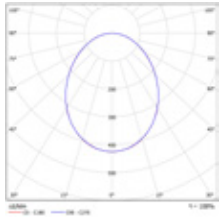

OP LT80

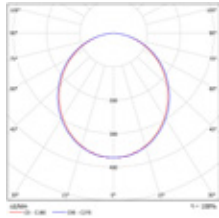

LEVANTO UGR LED

Recessed Luminaires

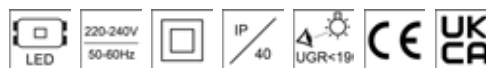

DESCRIPTION: **Recessed mounted LED panel**
Light distribution type: direct
Optical system: matt micro-prismatic diffuser, low glare
Housing: aluminum
Colour: white, RAL9016

GENERAL DATA: **Mains voltage:** 220-240V, 50-60Hz
LED lifetime, h: 50000/L70B50
SDCM: 5
Protection class IEC: II
Ingress protection code: IP40 (IP44 optional)
Mechanical impact resistance: IK02
Operating temperature range, °C: ta 0...+35

INSTALLATION: In modular suspended ceilings (600x600 / 1200x300), in ceilings with cut-out openings (mounting accessories to be ordered separately). Push-in terminal, 2x1x1.5mm² (4x2x2.5mm² for models with DALI)

ENVIRONMENT: Indoor

APPLICATION: Office, education, corridor, retail, public place



PRODUCT	LENGTH, mm	WIDTH, mm	HEIGHT, mm	LUMINAIRE OUTPUT*, lm	SYSTEM POWER*, W	SYSTEM EFFICACY*, lm/W	CRI	CCT*, K	WEIGHT, kg
Levanto UGR LED1x3650 G673 T840 MPRZ	595	595	33	3650	36,0	101	80+	4000	1,8
Levanto UGR LED1x3650 G674 T840 MPRZ	1195	295	33	3650	36,0	101	80+	4000	1,8
Levanto UGR LED1x3650 G673 T840 MPRZ DALI	595	595	33	3650	36,0	101	80+	4000	1,8
Levanto UGR LED1x3650 G674 T840 MPRZ DALI	1195	295	33	3650	36,0	101	80+	4000	1,8
Levanto UGR LED1x4300 G864 T840 MPRZ	595	595	33	4320	36,0	120	80+	4000	1,8
Levanto UGR LED1x4300 G864 T840 MPRZ DALI	595	595	33	4320	36,0	120	80+	4000	1,8

*Tolerance range for optical and electrical data: ±10%. Values apply to an ambient temperature of 25°C. NORTHCLIFFE LIGHTING is constantly developing and improving its products. The right is reserved to change any product specifications without prior notification

AVAILABLE ACCESSORIES:



Product: Recessed MTG FRAME S626x626 RAL9003S
Description: Frame for LED luminaire 595x595mm installation into plasterboard ceiling (1pcs), white steel



Product: Recessed MTG FRAME S326x1226 RAL9003S
Description: Frame for LED luminaire 1195x295mm installation into plasterboard ceiling (1pcs), white steel



Product: Decorative COVER 595x595/D500 Levanto PLN/UGR LED RAL9003
Description: Decorative cover with 500mm round opening for LED panel 595x595mm (1pcs), white steel



Product: Surface MTG BOX S606x606x70 Levanto PLN/UGR LED v2 RAL9003S
Description: Surface mounting box for LED panel 595x595mm (1pcs), white steel
**note - surface mounting box is compatible with EM3 option*



Product: Surface MTG BOX S1206x306x70 Levanto PLN/UGR LED v2/Calima R LED RAL9003S
Description: Surface mounting box for LED panel 1206x306mm (1pcs), white steel
**note - surface mounting box is compatible with EM3 option*



Product: Suspension MTG kit Levanto UGR/PLN G series
Description: Suspension kit for LED panel

AVAILABLE ACCESSORIES:



Product: Decorative REFLECTOR 595x595 Levanto PLN/UGR LED RAL
Description: Decorative reflector for LED panel 595x595mm (1pcs), steel



Product: Decorative BORDER 595x595 Levanto PLN/UGR LED RAL
Description: Decorative perforated reflector for LED panel 595x595mm (1pcs), steel



Product: Recessed MTG kit LEVANTO PLN G series
Description: Recessed MTG kit



Product: Surface MTG kit Levanto UGR/PLN G2 series S600x600 RAL9016
Description: Surface mounting kit for recessed LED luminaires 600x600mm (1pcs), white extruded aluminium



Product: Surface MTG kit Levanto UGR/PLN G series S300x1200 RAL9016
Description: Surface mounting kit for recessed LED luminaires 300x1200mm (1pcs), white extruded aluminium

OPTIONS AVAILABLE ON REQUEST:

LED	CONTROL GEAR	EMERGENCY	CONNECTION	PROTECTION
T830	DALI	EM3	WIE3-0.5m	IP44
T840	DALI LOOP	EM3B ⁴	WIE5D-0.5m	
	EAIRB-M ^{1 2 3}	EM3A ⁴	GBX2-0.1m	
	EAIRB-S ^{2 3}	EM3D ⁴	Europlug-1.5m	
			Europlug-3.0m	

- 1 For EAIRB-M option ingress protection IP20
- 2 Max system size 1x EAIRB-M + 3x EAIRB-S
- 3 Max wire length from EAIRB-M to last EAIRB-S - 11 m
- 4 EM3B, EM3A, EM3D options are not applicable with surface mounting accessories

MPRZ

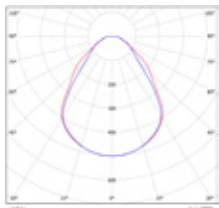

Decorative REFLECTOR Levanto PLN/UGR LED





LEVANTO PLN LED

Recessed Luminaires



- DESCRIPTION:** Recessed mounted LED panel
Light distribution type: direct
Optical system: opal diffuser, low glare
Housing: aluminum
Colour: white, RAL9016
-
- GENERAL DATA:** **Mains voltage:** 220-240V, 50-60Hz
LED lifetime, h: 50000/L70B50
SDCM: 5
Protection class IEC: II
Ingress protection code: IP40 (IP44 optional)
Mechanical impact resistance: IK02
Operating temperature range, °C: ta 0...+35
-
- INSTALLATION:** In modular suspended ceilings (600x600 / 1200x300), in ceilings with cut-out openings (accessories to be ordered separately). Push-in terminal, 2x1x1.5mm² (4x2x2.5mm² for models with DALI)
-
- ENVIRONMENT:** Indoor
-
- APPLICATION:** Office, education, corridor, retail, public place



PRODUCT	LENGTH, mm	WIDTH, mm	HEIGHT, mm	LUMINAIRE OUTPUT*, lm	SYSTEM POWER*, W	SYSTEM EFFICACY*, lm/W	CRI	CCT*, K	WEIGHT, kg
Levanto PLN LED1x3650 G671 T840 OP	595	595	33	3650	36,0	101	80+	4000	1,8
Levanto PLN LED1x3650 G672 T840 OP	1195	295	33	3650	36,0	101	80+	4000	1,8
Levanto PLN LED1x3650 G671 T840 OP DALI	595	595	33	3650	36,0	101	80+	4000	1,8
Levanto PLN LED1x3650 G672 T840 OP DALI	1195	295	33	3650	36,0	101	80+	4000	1,8

*Tolerance range for optical and electrical data: ±10%. Values apply to an ambient temperature of 25°C. NORTHCLIFFE LIGHTING is constantly developing and improving its products. The right is reserved to change any product specifications without prior notification

AVAILABLE ACCESSORIES:



Product: Recessed MTG FRAME S626x626 RAL9003S
Description: Frame for LED luminaire 595x595mm installation into plasterboard ceiling (1pcs), white steel



Product: Recessed MTG FRAME S326x1226 RAL9003S
Description: Frame for LED luminaire 1195x295mm installation into plasterboard ceiling (1pcs), white steel



Product: Decorative COVER 595x595/D500 Levanto PLN/UGR LED RAL9003
Description: Decorative cover with 500mm round opening for LED panel 595x595mm (1pcs), white steel



Product: Surface MTG BOX S606x606x70 Levanto PLN/UGR LED v2 RAL9003S
Description: Surface mounting box for LED panel 595x595mm (1pcs), white steel
**note - surface mounting box is compatible with EM3 option*



Product: Surface MTG BOX S1206x306x70 Levanto PLN/UGR LED v2/Calima R LED RAL9003S
Description: Surface mounting box for LED panel 1206x306mm (1pcs), white steel
**note - surface mounting box is compatible with EM3 option*



Product: Suspension MTG kit Levanto UGR/PLN G series
Description: Suspension kit for LED panel

AVAILABLE ACCESSORIES:



Product: Decorative REFLECTOR 595x595 Levanto PLN/UGR LED RAL
Description: Decorative reflector for LED panel 595x595mm (1pcs), steel



Product: Surface MTG kit Levanto UGR/PLN G2 series S600x600 RAL9016
Description: Surface mounting kit for recessed LED luminaires 600x600mm (1pcs), white extruded aluminium



Product: Decorative BORDER 595x595 Levanto PLN/UGR LED RAL
Description: Decorative perforated reflector for LED panel 595x595mm (1pcs), steel



Product: Surface MTG kit Levanto UGR/PLN G series S300x1200 RAL9016
Description: Surface mounting kit for recessed LED luminaires 300x1200mm (1pcs), white extruded aluminium



Product: Recessed MTG kit LEVANTO PLN G series
Description: Recessed MTG kit

OPTIONS AVAILABLE ON REQUEST:

LED	CONTROL GEAR	EMERGENCY	CONNECTION	PROTECTION
T830	DALI	EM3	WIE3-0.5m	IP44
T840	DALI LOOP	EM3B ⁴	WIE5D-0.5m	
	EAIRB-M ^{1 2 3}	EM3A ⁴	QBX2-0.1m	
	EAIRB-S ^{2 3}	EM3D ⁴	Europlug-1.5m	
			Europlug-3.0m	

- 1 For EAIRB-M option ingress protection IP20
- 2 Max system size 1x EAIRB-M + 3x EAIRB-S
- 3 Max wire length from EAIRB-M to last EAIRB-S - 11 m
- 4 EM3B, EM3A, EM3D options are not applicable with surface mounting accessories

OP

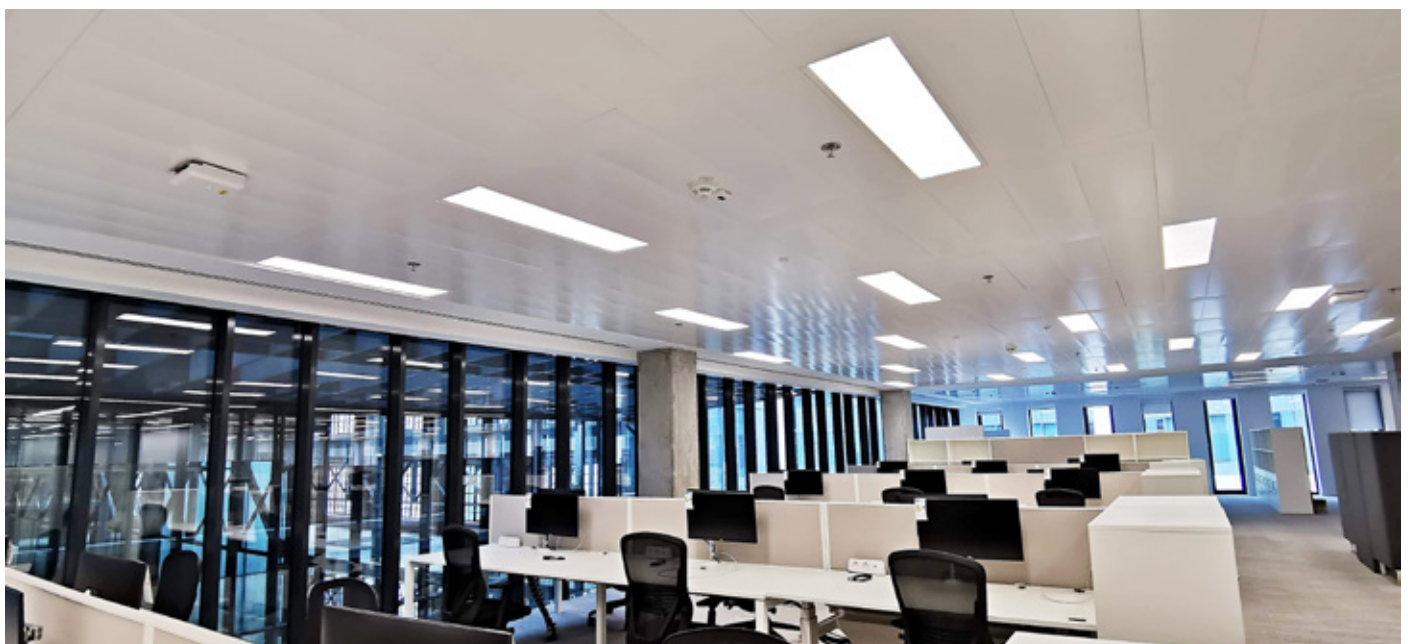
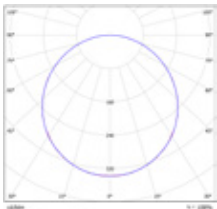



LEVANTO LED

Recessed Luminaires



DESCRIPTION: **Recessed mounted LED panel with selectable output, without driver**
Light distribution type: direct
Optical system: micro-prismatic diffuser, PS, back-lit, low glare / opal diffuser, PS, back-lit, low glare
Housing: aluminum
Colour: white, RAL9016

GENERAL DATA: **Mains voltage:** Dependant on selected driver
LED lifetime, h: 50000/L80B10
SDCM: 3
Protection class IEC: II
Ingress protection code: IP40 (IP44 optional)
Mechanical impact resistance: IK02
Operating temperature range, °C: ta 0...+35

INSTALLATION: In modular suspended ceilings (600), in ceilings with cut-out openings (accessories to be ordered separately). Push-in terminals

ENVIRONMENT: Indoor

APPLICATION: Office, education, retail, public place



PRODUCT**	LENGTH, mm	WIDTH, mm	HEIGHT, mm	LUMINAIRE OUTPUT*, lm	SYSTEM POWER*, W	SYSTEM EFFICACY*, lm/W	CRI	CCT*, K	WEIGHT, kg
Levanto UGR LED1x2750/3130/3470/3800/4180 J732 T840 MPRZ w/o driver	595	595	33	2750/3130/3470/3800/4180	18,0/21,0/23,0/25,0/28,0	153/149/151/152/149	80+	4000	1,8
Levanto UGR LED1x2750/3130/3470/3800/4180 J844 T840 MPRZ TP(a) w/o driver	595	595	33	2750/3130/3470/3800/4180	18,0/21,0/23,0/25,0/28,0	153/149/151/152/149	80+	4000	1,8
Levanto PLN LED1x2860/3250/3630/4010/4350 J731 T840 OP w/o driver	595	595	33	2860/3250/3630/4010/4350	18,0/21,0/23,0/25,0/28,0	159/155/158/160/155	80+	4000	1,5

*Tolerance range for optical and electrical data: ±10%. Values apply to an ambient temperature of 25°C. NORTHCLIFFE LIGHTING is constantly developing and improving its products. The right is reserved to change any product specifications without prior notification

**Panel and driver must be ordered separately

AVAILABLE ACCESSORIES:

Products:

LED ON/OFF driver Levanto J731-J732 (all powers)	ON/OFF LED driver, selectable: 18/21/23/25/28W
LED DALI2/SDIM LOOP driver Levanto J731-J732 (28W)	Dimmable DALI2 LED driver for 28W, with looping and switch-dim functionality
LED EAIRB-S driver Levanto J731-J732 (28W)	Dimmable EAIR type driver for 28W, with lighting control
LED COR LOOP driver Levanto J731-J732 (28W)	Dimmable driver for 28W, with looping and corridor functionality
EM3 & ON/OFF driver KIT Levanto J731-J732 (all powers)	Emergency 3h kit with ON/OFF LED driver, selectable: 18/21/23/25/28W
EM3 & DALI2 driver KIT Levanto J731-J732 (28W)	Emergency 3h kit with dimmable DALI2 LED driver for 28W, with looping and switch-dim functionality
EM3B & ON/OFF driver KIT Levanto J731-J732 (all powers)	Emergency 3h kit (best available technology) with ON/OFF LED driver, selectable: 18/21/23/25/28W
EM3B & DALI2 driver KIT Levanto J731-J732 (28W)	Emergency 3h kit (best available technology) with dimmable DALI2 LED driver for 28W, with looping and switch-dim functionality
EM3A & ON/OFF driver KIT Levanto J731-J732 (all powers)	Emergency 3h autotest kit with ON/OFF LED driver, selectable: 18/21/23/25/28W
EM3A & DALI2 driver KIT Levanto J731-J732 (28W)	Emergency 3h autotest kit with dimmable DALI2 LED driver for 28W, with looping and switch-dim functionality
EM3D & ON/OFF Levanto J731-J732 (all powers)	Emergency 3h DALI2 kit with ON/OFF LED driver, selectable: 18/21/23/25/28W
EM3D Levanto J731-J732 DALI driver KIT (28W)	Emergency 3h DALI2 kit with dimmable DALI2 LED driver for 28W, with looping and switch-dim functionality



Product: Recessed MTG FRAME S626x626 RAL9003S
Description: Frame for LED luminaire 595x595mm installation into plasterboard ceiling (1pcs), white steel



Product: Surface MTG BOX S606x606x70 Levanto PLN/UGR LED v2 RAL9003S
Description: Surface mounting box for LED panel 595x595mm (1pcs), white steel
**note - surface mounting box is compatible with EM3 option*



Product: Decorative COVER 595x595/D500 Levanto PLN/UGR LED RAL9003
Description: Decorative cover with 500mm round opening for LED panel 595x595mm (1pcs), white steel



Product: Suspension MTG kit Levanto UGR/PLN G series
Description: Suspension kit for LED panel



Product: Decorative REFLECTOR 595x595 Levanto PLN/UGR LED RAL
Description: Decorative reflector for LED panel 595x595mm (1pcs), steel



Product: Decorative BORDER 595x595 Levanto PLN/UGR LED RAL
Description: Decorative perforated reflector for LED panel 595x595mm (1pcs), steel



Product: Recessed MTG kit LEVANTO PLN G series
Description: Recessed MTG kit



Product: Surface MTG kit Levanto UGR/PLN G2 series S600x600 RAL9016
Description: Surface mounting kit for recessed LED luminaires 600x600mm (1pcs), white extruded aluminium

OPTIONS AVAILABLE ON REQUEST:

LED	CONTROL GEAR	CONNECTION	PROTECTION	OTHER
T830	EAIRB-M	WIE3-0.5m	IP44	W625
T840		WIE5D-0.5m		
		QBX2-0.1m		
		Europlug-1.5m		
		Europlug-3.0m		

MPRZ

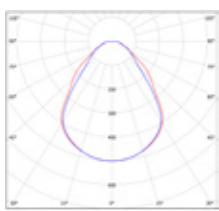

OP

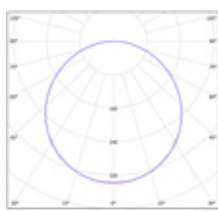

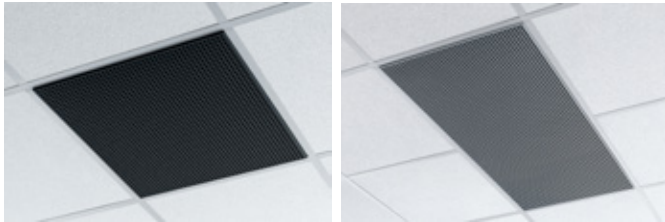
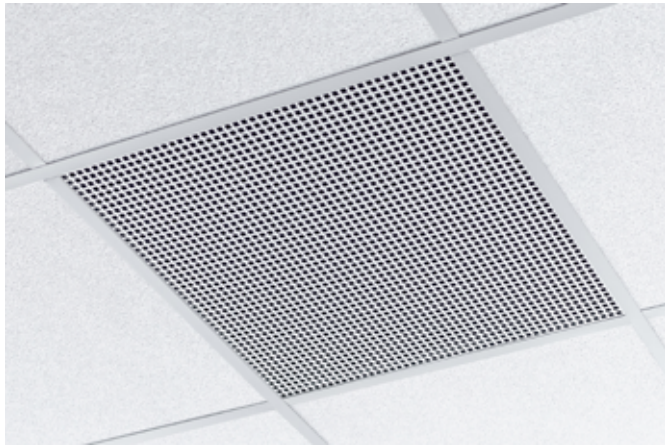

Metal grid ceiling tile

Ceiling accessories

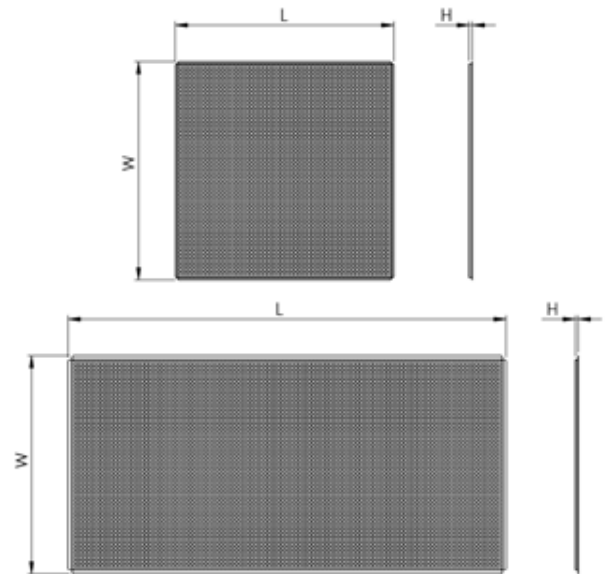

DESCRIPTION: Perforated metal grid tile for modular suspended ceilings / Perforated metal grid tile with 8mm drop for modular suspended ceilings (600 T24/T15)
Housing: steel
Colour: white, RAL9003S; black, RAL9005S; light grey, RAL9006S

ENVIRONMENT: Indoor

APPLICATION: Office, education, corridor, retail, public place

PRODUCT*	LENGTH, mm	WIDTH, mm	HEIGHT, mm	WEIGHT, kg
Metal grid ceiling tile Q8 595x595 RAL9003	595	595	5	0,9
Metal grid ceiling tile Q8 595x595 RAL9005	595	595	5	0,9
Metal grid ceiling tile Q8 595x595 RAL9006	595	595	5	0,9
Metal grid ceiling tile Q8 1195x595 RAL9003	1195	595	5	1,7
Metal grid ceiling tile Q8 1195x595 RAL9005	1195	595	5	1,7
Metal grid ceiling tile Q8 1195x595 RAL9006	1195	595	5	1,7
Metal grid drop ceiling tile Q8 595x595 T24 RAL9003	595	595	9	0,9
Metal grid drop ceiling tile Q8 595x595 T24 RAL9005	595	595	9	0,9
Metal grid drop ceiling tile Q8 595x595 T24 RAL9006	595	595	9	0,9
Metal grid drop ceiling tile Q8 1195x595 T24 RAL9003	1195	595	9	1,7
Metal grid drop ceiling tile Q8 1195x595 T24 RAL9005	1195	595	9	1,7
Metal grid drop ceiling tile Q8 1195x595 T24 RAL9006	1195	595	9	1,7
Metal grid drop ceiling tile Q8 595x595 T15 RAL9003	595	595	9	0,9
Metal grid drop ceiling tile Q8 595x595 T15 RAL9005	595	595	9	0,9
Metal grid drop ceiling tile Q8 595x595 T15 RAL9006	595	595	9	0,9
Metal grid drop ceiling tile Q8 1195x595 T15 RAL9003	1195	595	9	1,7
Metal grid drop ceiling tile Q8 1195x595 T15 RAL9005	1195	595	9	1,7
Metal grid drop ceiling tile Q8 1195x595 T15 RAL9006	1195	595	9	1,7

*Q8 - 8x8mm square perforation

SPACE Q LED

Recessed Luminaires



DESCRIPTION: Recessed mounted decorative LED luminaire
Light distribution type: direct
Optical system: opal PMMA diffuser
Housing: steel
Colour: white, RAL9016

GENERAL DATA: Mains voltage: 220-240V, 50-60Hz
LED lifetime, h: 50000/L70B50
SDCM: 5
Protection class IEC: II
Ingress protection code: IP40
Mechanical impact resistance: IK02
Operating temperature range, °C: ta 0..+35

INSTALLATION: In modular suspended ceilings. Push-in terminal, 2x1x1.5mm²

ENVIRONMENT: Indoor

APPLICATION: Office, education, corridor, retail, public place



PRODUCT	LENGTH, mm	WIDTH, mm	HEIGHT, mm	LUMINAIRE OUTPUT*, lm	SYSTEM POWER*, W	SYSTEM EFFICACY*, lm/W	CRI	CCT*, K	WEIGHT, kg
Space Q LED1x3500 J246 T840 OP	595	595	58	3500	36,0	97	80+	4000	2,0
Space Q LED1x3500 J247 T840 OP	595	595	83	3500	36,0	97	80+	4000	2,0
Space Q LED1x3500 J248 T840 OP	595	595	133	3500	36,0	97	80+	4000	2,0

*Tolerance range for optical and electrical data: ±10%. Values apply to an ambient temperature of 25°C. NORTHCLIFFE LIGHTING is constantly developing and improving its products. The right is reserved to change any product specifications without prior notification

AVAILABLE ACCESSORIES:



Product: Space Q acoustic ceiling tile H25mm/ H50mm/ H100mm
Description: Decorative acoustic ceiling tile accessory for interesting combinations with Space Q LED luminaires height: 25mm/ 50mm/ 100mm (1pc)

OP

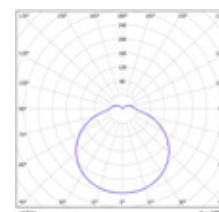

OPTIONS AVAILABLE ON REQUEST:

LED	CONTROL GEAR	CONNECTION
T830	DALI	WIE3-0.5m
T840	DALI LOOP	WIE5D-0.5m
		QBX3-0.1m
		Europlug-1.5m
		Europlug-3.0m



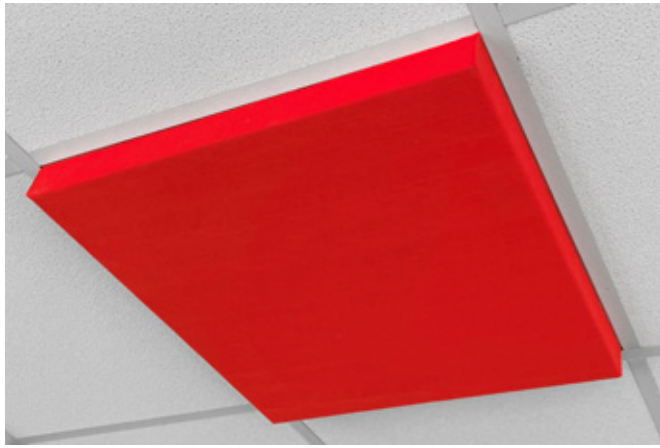

Space Q acoustic ceiling tile

Ceiling accessories

DESCRIPTION: Decorative acoustic ceiling tile accessory for interesting combinations with Space Q LED luminaires

Housing: felt with steel frame

Colour: made to the customer's specification

ENVIRONMENT: Indoor

APPLICATION: Office, education, corridor, retail, public place



PRODUCT	LENGTH, mm	WIDTH, mm	HEIGHT, mm	WEIGHT, kg
Space Q acoustic ceiling tile H25mm	595	595	25	1,2
Space Q acoustic ceiling tile H50mm	595	595	50	1,6
Space Q acoustic ceiling tile H100mm	595	595	100	2,4

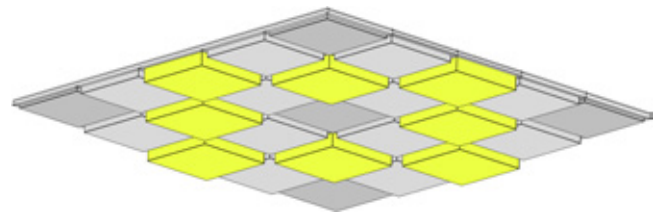
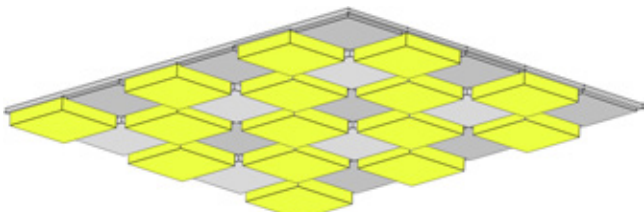

BARBER R LED

Recessed Luminaires



DESCRIPTION: **Recessed mounted LED luminaire**
Light distribution type: direct
Optical system: matt aluminum reflector, asymmetrical, opal PMMA diffuser
Housing: steel
Colour: white, RAL9003

GENERAL DATA: **Mains voltage:** 220-240V, 0/50-60Hz
LED lifetime, h: 50000/L80B10
SDCM: 3
Protection class IEC: I
Ingress protection code: IP40/20
Mechanical impact resistance: IK02
Operating temperature range, °C: ta 0...+35

INSTALLATION: In modular suspended ceilings (600), in ceilings with cut-out openings (on request). Push-in terminal, 3x2x2.5mm²

ENVIRONMENT: Indoor

APPLICATION: Office, education, showroom, retail, public place

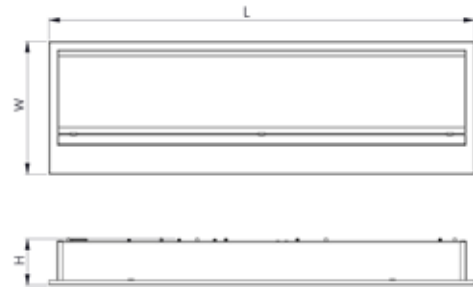

PRODUCT	LENGTH, mm	WIDTH, mm	HEIGHT, mm	LUMINAIRE OUTPUT*, lm	SYSTEM POWER*, W	SYSTEM EFFICACY*, lm/W	CRI	CCT*, K	WEIGHT, kg
Barber R LED1x1550 G874 T840 OP LT80	595	185	62	1518	13,6	111	80+	4000	1,9
Barber R LED1x2100 G875 T840 OP LT80	595	185	62	2086	19,5	107	80+	4000	1,9
Barber R LED1x3050 G876 T840 OP LT80	1195	185	62	3035	25,8	118	80+	4000	3,6
Barber R LED1x4200 G877 T840 OP LT80	1195	185	62	4173	37,8	110	80+	4000	3,6

*Tolerance range for optical and electrical data: ±10%. Values apply to an ambient temperature of 25°C. NORTHCLIFFE LIGHTING is constantly developing and improving its products. The right is reserved to change any product specifications without prior notification

AVAILABLE ACCESSORIES:



Product: Recessed MTG brackets Barber R LED (185mm width)
Description: Support brackets for installation into a plasterboard ceiling. Barber R LED (185mm width), 2pcs

OP LT80

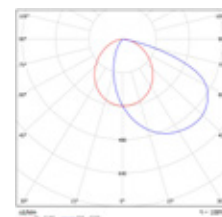

OPTIONS AVAILABLE ON REQUEST:

LED	REFLECTOR AND OPTICS	CONTROL GEAR	EMERGENCY	CONNECTION	OTHER
T830	OP LT80	DALI	EM3	WIE3-0.5m	SB
T840	OP TP(a)		EM3B	WIE5D-0.5m	W625
			EM3A	Schuko-1.5m	
			EM3D	Schuko-3.0m	

SURFACE AND SUSPENDED LUMINAIRES



ETESIAN S LED

Surface and Suspended Luminares



DESCRIPTION: **Surface mounted LED luminaire**
Light distribution type: direct
Optical system: double parabolic reflector with lenses, low glare
Housing: steel
Colour: white, RAL9003S

GENERAL DATA: **Mains voltage:** 220-240V, 0/50-60Hz
LED lifetime, h: 100000/L80B10
SDCM: 3
Protection class IEC: I
Ingress protection code: IP40
Mechanical impact resistance: IK05
Operating temperature range, °C: ta 0...+35

INSTALLATION: On the ceiling. Models with light output level marking LO1...4 has a possibility to be installed in line. Push-in terminal, 3x2x2.5mm²

ENVIRONMENT: Indoor

APPLICATION: Office, education, corridor, retail, public place

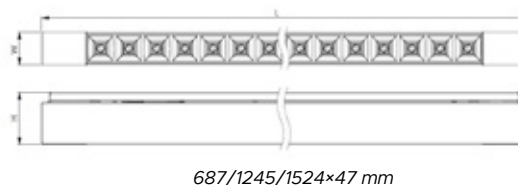

PRODUCT	LENGTH, mm	WIDTH, mm	HEIGHT, mm	LUMINAIRE OUTPUT*, lm	SYSTEM POWER*, W	SYSTEM EFFICACY*, lm/W	CRI	CCT*, K	WEIGHT, kg
Etesian S LED2x1500 G966 T840 WGC	600	600	43	2920	17,6	166	80+	4000	4,2
Etesian S LED2x1800 G967 T840 WGC	600	600	43	3583	21,9	164	80+	4000	4,2
Etesian S LED2x2150 G968 T840 WGC	600	600	43	4223	25,9	163	80+	4000	4,2
Etesian S LED2x2450 G969 T840 WGC	600	600	43	4867	30,8	158	80+	4000	4,2
Etesian S LED1x1500 G970 T840 WGC LO1	687	47	74	1460	9,7	151	80+	4000	1,5
Etesian S LED1x1800 G971 T840 WGC LO2	687	47	74	1791	11,5	156	80+	4000	1,5
Etesian S LED1x2150 G972 T840 WGC LO3	687	47	74	2111	13,8	153	80+	4000	1,5
Etesian S LED1x2450 G973 T840 WGC LO4	687	47	74	2433	16,3	149	80+	4000	1,5
Etesian S LED1x2950 G974 T840 WGC LO1	1245	47	74	2920	17,6	166	80+	4000	2,7
Etesian S LED1x3600 G975 T840 WGC LO2	1245	47	74	3583	21,9	164	80+	4000	2,7
Etesian S LED1x4250 G976 T840 WGC LO3	1245	47	74	4223	25,9	163	80+	4000	2,7
Etesian S LED1x4900 G977 T840 WGC LO4	1245	47	74	4867	30,8	158	80+	4000	2,7
Etesian S LED1x3650 G978 T840 WGC LO1	1524	47	74	3650	21,7	168	80+	4000	3,3
Etesian S LED1x4500 G979 T840 WGC LO2	1524	47	74	4479	26,8	167	80+	4000	3,3
Etesian S LED1x5300 G980 T840 WGC LO3	1524	47	74	5278	32,0	165	80+	4000	3,3
Etesian S LED1x6150 G981 T840 WGC LO4	1524	47	74	6147	37,8	163	80+	4000	3,3

PRODUCT	LENGTH, mm	WIDTH, mm	HEIGHT, mm	LUMINAIRE OUTPUT*, lm	SYSTEM POWER*, W	SYSTEM EFFICACY*, lm/W	CRI	CCT*, K	WEIGHT, kg
Etesian S LED2x1350 G966 T840 BGC	600	600	43	2695	17,6	153	80+	4000	4,2
Etesian S LED2x1700 G967 T840 BGC	600	600	43	3307	21,9	151	80+	4000	4,2
Etesian S LED2x1950 G968 T840 BGC	600	600	43	3898	25,9	151	80+	4000	4,2
Etesian S LED2x2250 G969 T840 BGC	600	600	43	4492	30,8	146	80+	4000	4,2
Etesian S LED1x1350 G970 T840 BGC LO1	687	47	74	1348	9,7	139	80+	4000	1,5
Etesian S LED1x1700 G971 T840 BGC LO2	687	47	74	1654	11,5	144	80+	4000	1,5
Etesian S LED1x1950 G972 T840 BGC LO3	687	47	74	1949	13,8	141	80+	4000	1,5
Etesian S LED1x2250 G973 T840 BGC LO4	687	47	74	2246	16,3	138	80+	4000	1,5
Etesian S LED1x2700 G974 T840 BGC LO1	1245	47	74	2695	17,6	153	80+	4000	2,7
Etesian S LED1x3350 G975 T840 BGC LO2	1245	47	74	3307	21,9	151	80+	4000	2,7
Etesian S LED1x3900 G976 T840 BGC LO3	1245	47	74	3898	25,9	151	80+	4000	2,7
Etesian S LED1x4500 G977 T840 BGC LO4	1245	47	74	4492	30,8	146	80+	4000	2,7
Etesian S LED1x3400 G978 T840 BGC LO1	1524	47	74	3369	21,7	155	80+	4000	3,3
Etesian S LED1x4150 G979 T840 BGC LO2	1524	47	74	4134	26,8	154	80+	4000	3,3
Etesian S LED1x4900 G980 T840 BGC LO3	1524	47	74	4872	32,0	152	80+	4000	3,3
Etesian S LED1x5700 G981 T840 BGC LO4	1524	47	74	5674	37,8	150	80+	4000	3,3

*Tolerance range for optical and electrical data: ±10%. Values apply to an ambient temperature of 25°C. NORTHCLIFFE LIGHTING is constantly developing and improving its products. The right is reserved to change any product specifications without prior notification

AVAILABLE ACCESSORIES:



Product: I-JOIN MTG KIT Etesian S/U LED
Description: "I" type join kit for connecting luminaires in-line

OPTIONS AVAILABLE ON REQUEST:

LED	REFLECTOR AND OPTICS	CONTROL GEAR	SENSORS	EMERGENCY	CONNECTION	COLOUR
T830	WGC	DALI	PIR	EM3	CBF3-1.5m	RAL
T840	BGC	EAIRB-M ^{1 2 3 4}		EM3B	CBF3-3.0m	
T930	WMC	EAIRB-S ^{2 3 4}		EM3A	1LIN I-join L ⁵	
T940	BMC	BLT		EM3D	1LIN I-join LL ⁵	
	MGC	COR				
	MMC	COR1min				
	WAC/BAC	COR30min				

- 1 Ingress protection IP20
- 2 Max system size 1x EAIRB-M + 3x EAIRB-S
- 3 Max wire length from EAIRB-M to last EAIRB-S - 11 m
- 4 EAIRB options are not applicable for models: G970; G971
- 5 LIN and I-join options are only available for models with light output level marking LO1...4

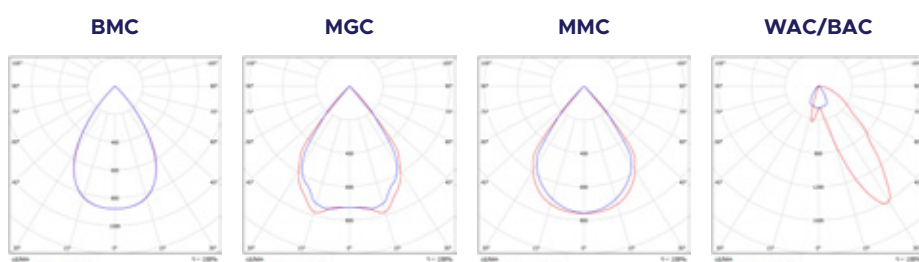
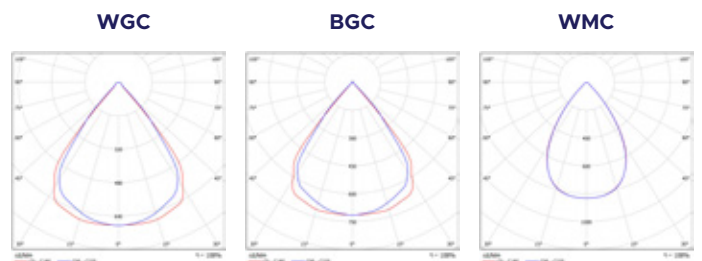

ETESIAN U LED

Surface and Suspended Luminares

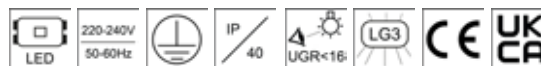

DESCRIPTION: **Suspended LED luminaire**
Light distribution type: direct (optional direct/indirect LG3 versions)
Optical system: double parabolic reflector with lenses, low glare
Housing: steel
Colour: white, RAL9003S

GENERAL DATA: **Mains voltage:** 220-240V, 0/50-60Hz
LED lifetime, h: 100000/L80B10
SDCM: 3
Protection class IEC: I
Ingress protection code: IP40
Mechanical impact resistance: IK05
Operating temperature range, °C: ta 0...+35

INSTALLATION: Suspended (wire, cable and cap to be ordered separately). Push-in terminal, 3x2x2.5mm²

ENVIRONMENT: Indoor

APPLICATION: Office, education, retail, public place

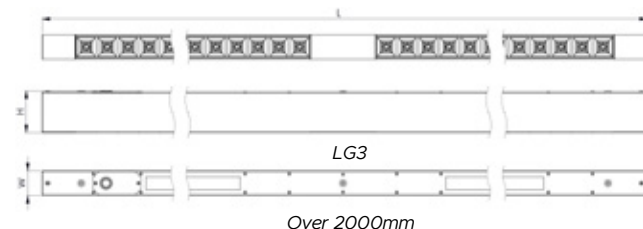
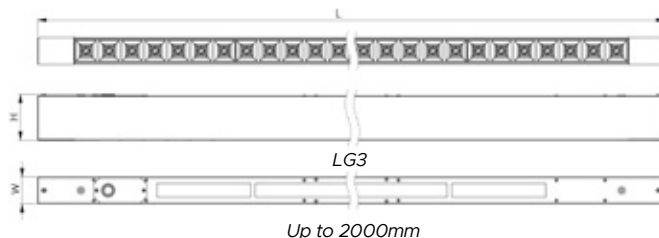

PRODUCT	LENGTH, mm	WIDTH, mm	HEIGHT, mm	LUMINAIRE OUTPUT*, lm	SYSTEM POWER*, W	SYSTEM EFFICACY*, lm/W	CRI	CCT*, K	WEIGHT, kg
Etesian U LED1x2950 J102 T840 WGC LO1	1245	47	60	2920	17,6	166	80+	4000	2,3
Etesian U LED1x3600 J103 T840 WGC LO2	1245	47	60	3583	21,9	164	80+	4000	2,3
Etesian U LED1x4250 J104 T840 WGC LO3	1245	47	60	4223	26,1	162	80+	4000	2,3
Etesian U LED1x4900 J105 T840 WGC LO4	1245	47	60	4867	30,8	158	80+	4000	2,3
Etesian U LED1x3650 J106 T840 WGC LO1	1524	47	60	3650	21,7	168	80+	4000	2,6
Etesian U LED1x4500 J107 T840 WGC LO2	1524	47	60	4479	26,8	167	80+	4000	2,6
Etesian U LED1x5300 J108 T840 WGC LO3	1524	47	60	5278	32,0	165	80+	4000	2,6
Etesian U LED1x6150 J109 T840 WGC LO4	1524	47	60	6147	37,8	163	80+	4000	2,6
Etesian U LED1x5850 J110 T840 WGC LO1	2424	47	60	5840	33,3	175	80+	4000	4,0
Etesian U LED1x7200 J111 T840 WGC LO2	2424	47	60	7166	41,9	171	80+	4000	4,0
Etesian U LED1x8450 J112 T840 WGC LO3	2424	47	60	8446	50,6	167	80+	4000	4,0
Etesian U LED1x9750 J113 T840 WGC LO4	2424	47	60	9734	59,0	165	80+	4000	4,0
Etesian U LED1x7300 J114 T840 WGC LO1	2982	47	60	7300	41,6	175	80+	4000	4,7
Etesian U LED1x9000 J115 T840 WGC LO2	2982	47	60	8957	52,4	171	80+	4000	4,7
Etesian U LED1x10600 J116 T840 WGC LO3	2982	47	60	10557	62,6	169	80+	4000	4,7
Etesian U LED1x12300 J117 T840 WGC LO4	2982	47	60	12293	73,3	168	80+	4000	4,7

PRODUCT	LENGTH, mm	WIDTH, mm	HEIGHT, mm	LUMINAIRE OUTPUT*, lm	SYSTEM POWER*, W	SYSTEM EFFICACY*, lm/W	CRI	CCT*, K	WEIGHT, kg
Etesian U LED1x2700 J102 T840 BGC LO1	1245	47	60	2695	17,6	153	80+	4000	2,3
Etesian U LED1x3350 J103 T840 BGC LO2	1245	47	60	3307	21,9	151	80+	4000	2,3
Etesian U LED1x3900 J104 T840 BGC LO3	1245	47	60	3898	26,1	149	80+	4000	2,3
Etesian U LED1x4500 J105 T840 BGC LO4	1245	47	60	4492	30,8	146	80+	4000	2,3
Etesian U LED1x3400 J106 T840 BGC LO1	1524	47	60	3369	21,7	155	80+	4000	2,6
Etesian U LED1x4150 J107 T840 BGC LO2	1524	47	60	4134	26,8	154	80+	4000	2,6
Etesian U LED1x4900 J108 T840 BGC LO3	1524	47	60	4872	32,0	152	80+	4000	2,6
Etesian U LED1x5700 J109 T840 BGC LO4	1524	47	60	5674	37,8	150	80+	4000	2,6
Etesian U LED1x5400 J110 T840 BGC LO1	2424	47	60	5391	33,3	162	80+	4000	4,0
Etesian U LED1x6650 J111 T840 BGC LO2	2424	47	60	6615	41,9	158	80+	4000	4,0
Etesian U LED1x7800 J112 T840 BGC LO3	2424	47	60	7796	50,6	154	80+	4000	4,0
Etesian U LED1x9000 J113 T840 BGC LO4	2424	47	60	8985	59,0	152	80+	4000	4,0
Etesian U LED1x6750 J114 T840 BGC LO1	2982	47	60	6738	41,6	162	80+	4000	4,7
Etesian U LED1x8300 J115 T840 BGC LO2	2982	47	60	8268	52,4	158	80+	4000	4,7
Etesian U LED1x9750 J116 T840 BGC LO3	2982	47	60	9745	62,6	156	80+	4000	4,7
Etesian U LED1x11350 J117 T840 BGC LO4	2982	47	60	11348	73,3	155	80+	4000	4,7

*Tolerance range for optical and electrical data: ±10%. Values apply to an ambient temperature of 25°C. NORTHCLIFFE LIGHTING is constantly developing and improving its products. The right is reserved to change any product specifications without prior notification

OPTIONS AVAILABLE ON REQUEST:

LED	REFLECTOR AND OPTICS	CONTROL GEAR	SENSORS	EMERGENCY	CONNECTION	OTHER	COLOUR
T830	WGC	DALI	PIR	EM3	CBF3-2.0m clear	1LIN I-join L	RAL
T840	BGC	EAIRB-M ^{1 2 3 4}		EM3B	CBF3-3.0m clear	1LIN I-join LL	
	WMC	EAIRB-S ^{3 4}		EM3A	CBF5-2.0m clear		
	BMC	BLT		EM3D	CBF5-3.0m clear		
	MGC	COR					
	MMC	COR1min					
	WAC/BAC	COR30min					
		PULL					
		PULLDIM					

- 1 For EAIRB, EAIRB-M options ingress protection IP20
- 2 The EAIRB sensor is positioned in the end of the luminaire for lengths up to 2000mm, and in the middle of the luminaire for lengths over 2000mm
- 3 Max system size 1x EAIRB-M + 3x EAIRB-S
- 4 Max wire length from EAIRB-M to last EAIRB-S - 11 m

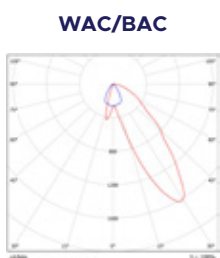
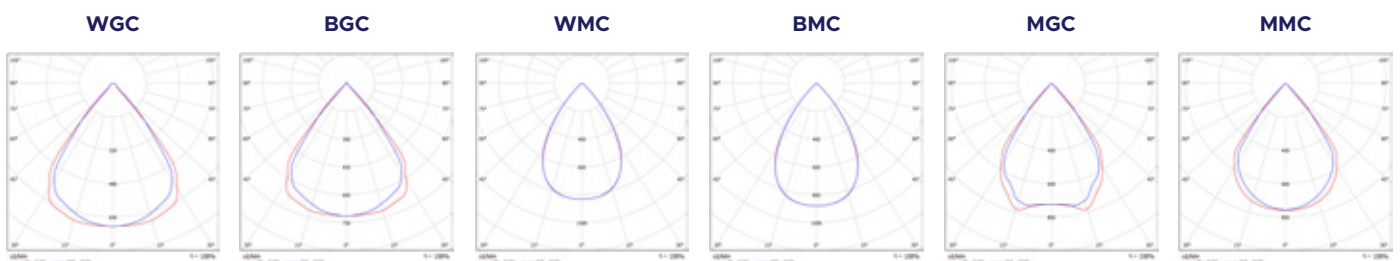

PRODUCT	LENGTH, mm	WIDTH, mm	HEIGHT, mm	LUMINAIRE OUTPUT*, lm	SYSTEM POWER*, W	SYSTEM EFFICACY*, lm/W	CRI	CCT*, K	WEIGHT, kg
Etesian U LED1x2950/1450 J118 T840 WGC LG3 LO1	1245	47	78	4335	25,5	170	80+	4000	2,9
Etesian U LED1x3600/1750 J119 T840 WGC LG3 LO2	1245	47	78	5322	32,2	165	80+	4000	2,9
Etesian U LED1x4250/2050 J120 T840 WGC LG3 LO3	1245	47	78	6273	38,5	163	80+	4000	2,9
Etesian U LED1x4900/2400 J121 T840 WGC LG3 LO4	1245	47	78	7236	45,3	160	80+	4000	2,9
Etesian U LED1x3650/1700 J122 T840 WGC LG3 LO1	1524	47	78	5348	31,8	168	80+	4000	3,5
Etesian U LED1x4500/2100 J123 T840 WGC LG3 LO2	1524	47	78	6565	39,7	165	80+	4000	3,5
Etesian U LED1x5300/2500 J124 T840 WGC LG3 LO3	1524	47	78	7737	48,0	161	80+	4000	3,5
Etesian U LED1x6150/2850 J125 T840 WGC LG3 LO4	1524	47	78	8989	56,1	160	80+	4000	3,5
Etesian U LED1x5850/2850 J126 T840 WGC LG3 LO1	2424	47	78	8670	49,9	174	80+	4000	5,5
Etesian U LED1x7200/3500 J127 T840 WGC LG3 LO2	2424	47	78	10644	62,3	171	80+	4000	5,5
Etesian U LED1x8450/4100 J128 T840 WGC LG3 LO3	2424	47	78	12546	75,3	167	80+	4000	5,5
Etesian U LED1x9750/4750 J129 T840 WGC LG3 LO4	2424	47	78	14473	88,8	163	80+	4000	5,5
Etesian U LED1x7300/3400 J130 T840 WGC LG3 LO1	2982	47	78	10695	61,6	174	80+	4000	6,7
Etesian U LED1x9000/4200 J131 T840 WGC LG3 LO2	2982	47	78	13129	77,7	169	80+	4000	6,7
Etesian U LED1x10600/4950 J132 T840 WGC LG3 LO3	2982	47	78	15475	94,0	165	80+	4000	6,7
Etesian U LED1x12300/5700 J133 T840 WGC LG3 LO4	2982	47	78	17977	111,1	162	80+	4000	6,7
Etesian U LED1x2700/1450 J118 T840 BGC LG3 LO1	1245	47	78	4110	25,5	161	80+	4000	2,9
Etesian U LED1x3350/1750 J119 T840 BGC LG3 LO2	1245	47	78	5046	32,2	157	80+	4000	2,9
Etesian U LED1x3900/2050 J120 T840 BGC LG3 LO3	1245	47	78	5948	38,5	154	80+	4000	2,9
Etesian U LED1x4500/2400 J121 T840 BGC LG3 LO4	1245	47	78	6861	45,3	151	80+	4000	2,9
Etesian U LED1x3400/1700 J122 T840 BGC LG3 LO1	1524	47	78	5067	31,8	159	80+	4000	3,5
Etesian U LED1x4150/2100 J123 T840 BGC LG3 LO2	1524	47	78	6220	39,7	157	80+	4000	3,5
Etesian U LED1x4900/2500 J124 T840 BGC LG3 LO3	1524	47	78	7331	48,0	153	80+	4000	3,5
Etesian U LED1x5700/2850 J125 T840 BGC LG3 LO4	1524	47	78	8516	56,1	152	80+	4000	3,5
Etesian U LED1x5400/2850 J126 T840 BGC LG3 LO1	2424	47	78	8221	49,9	165	80+	4000	5,5
Etesian U LED1x6650/3500 J127 T840 BGC LG3 LO2	2424	47	78	10093	62,3	162	80+	4000	5,5
Etesian U LED1x7800/4100 J128 T840 BGC LG3 LO3	2424	47	78	11896	75,3	158	80+	4000	5,5
Etesian U LED1x9000/4750 J129 T840 BGC LG3 LO4	2424	47	78	13724	88,8	155	80+	4000	5,5
Etesian U LED1x6750/3400 J130 T840 BGC LG3 LO1	2982	47	78	10133	61,6	164	80+	4000	6,7
Etesian U LED1x8300/4200 J131 T840 BGC LG3 LO2	2982	47	78	12440	77,7	160	80+	4000	6,7
Etesian U LED1x9750/4950 J132 T840 BGC LG3 LO3	2982	47	78	14663	94,0	156	80+	4000	6,7
Etesian U LED1x11350/5700 J133 T840 BGC LG3 LO4	2982	47	78	17032	111,1	153	80+	4000	6,7

*Tolerance range for optical and electrical data: ±10%. Values apply to an ambient temperature of 25°C. NORTHCLIFFE LIGHTING is constantly developing and improving its products. The right is reserved to change any product specifications without prior notification

AVAILABLE ACCESSORIES:



Product: I-JOIN MTG KIT Etesian U LED LG3
Description: "I" type join kit for connecting luminaires in-line, RAL9003S



Product: Suspension MTG KIT SUSI
Description: Suspension wire set "I" type, 1,5m adjustable, 1pcs
**note - at least 2pcs MTG KIT SUSI for one fitting required. For exact quantity please refer to installation manual*



Product: CAP cable 3x0.75 2.0m clear
Description: Cable 3x0.75mm² for suspended luminaire up to 2.0 meters, transparent

Product: CAP4, light grey/ white/ black
Description: Square decorative metal cap for hiding cable inlet with suspension wire attachment point, push-in terminals 3x1x1.5mm², light grey/ white/ black



Product: CAP cable clip D6.3mm SET clear
Description: Cable and suspension wire clip set, 4pcs. For cable diameter up to 6,3mm and wire diameter 1mm



Product: CAP5, light grey/ white/ black
Description: Square decorative metal cap for hiding cable inlet with suspension wire attachment point, push-in terminals 5x1x1.5mm², light grey/ white/ black

OPTIONS AVAILABLE ON REQUEST:

LED	REFLECTOR AND OPTICS	CONTROL GEAR	SENSORS	EMERGENCY	CONNECTION	OTHER	COLOUR
T830	WGC	DALI	PIR	EM3 ⁷	CBF3-2.0m clear	1LIN I-join L	RAL
T840	BGC	DALIsep		EM3B ⁷	CBF3-3.0m clear	1LIN I-join LL	
	WMC	EAIRB-M ^{1 2 3 4 5}		EM3A ⁷	CBF5-2.0m clear		
	BMC	EAIRB-S ^{3 4 5}		EM3D ⁷	CBF5-3.0m clear		
	MGC	BLT					
	MMC	COR ⁶					
		COR1min ⁶					
		COR30min ⁶					
		PULL					
		PULLDIM					
		Lsep					

- 1 For EAIRB, EAIRB-M options ingress protection IP20
- 2 The EAIRB sensor is positioned in the end of the luminaire for lengths up to 2000mm, and in the middle of the luminaire for lengths over 2000mm
- 3 Max system size 1x EAIRB-M + 3x EAIRB-S
- 4 Max wire length from EAIRB-M to last EAIRB-S - 11 m
- 5 EAIRB options are not applicable for model: J133
- 6 COR options are not applicable for models: J132; J133
- 7 EM options are not compatible with some of COR and EAIRB models. Please check before placing an order

WGC LG3

BGC LG3

MGC LG3

MMC LG3

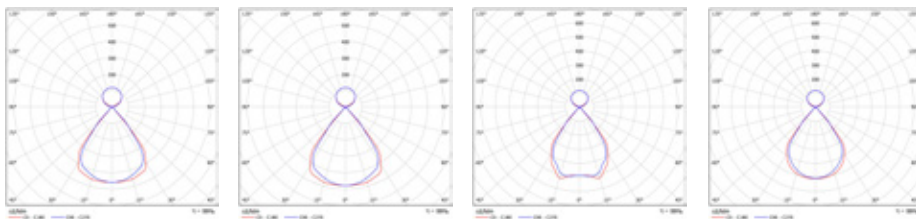

CALIMA S LED

Surface and Suspended Luminaires

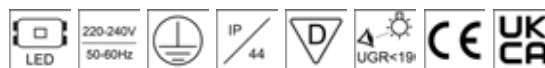

DESCRIPTION: **Surface mounted LED luminaire**
Light distribution type: direct
Optical system: matt micro-prismatic PMMA diffuser, low glare / translucent micro-prismatic PMMA diffuser
Housing: steel
Colour: white, RAL9003S

GENERAL DATA: **Mains voltage:** 220-240V, 0/50-60Hz, basic version: 220-240V, 50-60Hz
LED lifetime, h: 100000/L80B10, basic version: 50000/L80B10
SDCM: 3
Protection class IEC: I
Ingress protection code: IP44
Mechanical impact resistance: IK05
Operating temperature range, °C: ta 0...+35

INSTALLATION: Surface mounted LED luminaire. Push-in terminal, 5x2x2.5mm²

ENVIRONMENT: Indoor

APPLICATION: Office, education, corridor, retail, public place

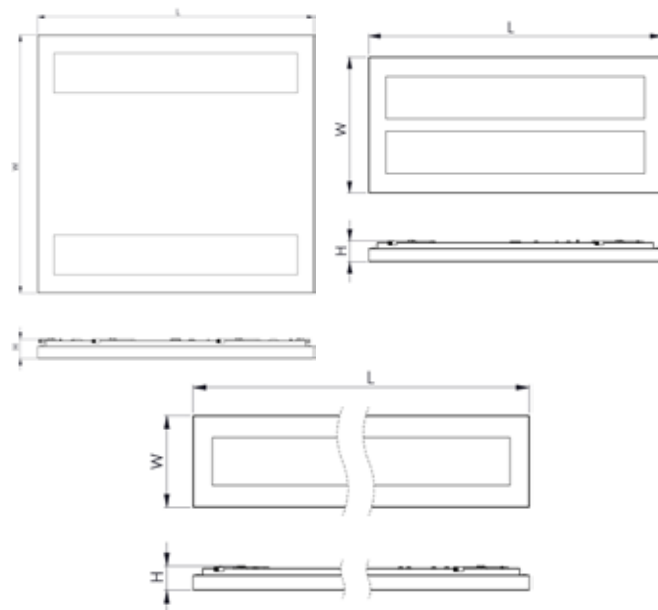

PRODUCT	LENGTH, mm	WIDTH, mm	HEIGHT, mm	LUMINAIRE OUTPUT*, lm	SYSTEM POWER*, W	SYSTEM EFFICACY*, lm/W	CRI	CCT*, K	WEIGHT, kg
Calima S LED1x1500 G150 T840 DPRZ LT80	635	175	47	1475	10,1	146	80+	4000	2,2
Calima S LED1x2050 G151 T840 DPRZ LT80	635	175	47	2017	13,9	145	80+	4000	2,2
Calima S LED1x2800 G152 T840 DPRZ LT80	635	175	47	2794	19,4	144	80+	4000	2,2
Calima S LED1x2700 G153 T840 DPRZ LT80	1203	175	47	2689	18,5	145	80+	4000	3,9
Calima S LED1x3550 G154 T840 DPRZ LT80	1203	175	47	3507	22,3	157	80+	4000	3,9
Calima S LED1x4600 G155 T840 DPRZ LT80	1203	175	47	4570	29,8	153	80+	4000	3,9
Calima S LED1x5100 G156 T840 DPRZ LT80	1203	175	47	5098	33,7	151	80+	4000	3,9
Calima S LED1x7100 G158 T840 DPRZ LT80	1203	175	47	7071	46,3	153	80+	4000	3,9
Calima S LED1x3400 G159 T840 DPRZ LT80	1483	175	47	3362	22,6	149	80+	4000	4,8
Calima S LED1x4400 G160 T840 DPRZ LT80	1483	175	47	4383	27,6	159	80+	4000	4,8
Calima S LED1x5750 G161 T840 DPRZ LT80	1483	175	47	5713	37,2	154	80+	4000	4,8
Calima S LED1x6400 G162 T840 DPRZ LT80	1483	175	47	6372	42,6	150	80+	4000	4,8

PRODUCT	LENGTH, mm	WIDTH, mm	HEIGHT, mm	LUMINAIRE OUTPUT*, lm	SYSTEM POWER*, W	SYSTEM EFFICACY*, lm/W	CRI	CCT*, K	WEIGHT, kg
Calima S LED1x8850 G164 T840 DPRZ LT80	1483	175	47	8839	57,3	154	80+	4000	4,8
Calima S LED2x1350 G165 T840 DPRZ LT80	635	295	47	2689	17,7	152	80+	4000	3,7
Calima S LED2x1950 G166 T840 DPRZ LT80	635	295	47	3726	26,5	141	80+	4000	3,7
Calima S LED2x2550 G167 T840 DPRZ LT80	635	295	47	5098	33,7	151	80+	4000	3,7
Calima S LED2x1350 G168 T840 DPRZ LT80	635	595	47	2689	17,7	152	80+	4000	5,5
Calima S LED2x1950 G169 T840 DPRZ LT80	635	595	47	3726	26,2	142	80+	4000	5,5
Calima S LED2x2550 G170 T840 DPRZ LT80	635	595	47	5098	33,7	151	80+	4000	5,5
Calima S LED3x1350 G171 T840 DPRZ LT80	635	595	47	4034	25,9	156	80+	4000	5,9
Calima S LED3x1900 G172 T840 DPRZ LT80	635	595	47	5589	38,4	146	80+	4000	5,9
Calima S LED1x1600 G150 T840 MPRZ LT92	635	175	47	1579	10,1	156	80+	4000	2,2
Calima S LED1x2200 G151 T840 MPRZ LT92	635	175	47	2159	13,9	155	80+	4000	2,2
Calima S LED1x3000 G152 T840 MPRZ LT92	635	175	47	2992	19,4	154	80+	4000	2,2
Calima S LED1x2900 G153 T840 MPRZ LT92	1203	175	47	2879	18,5	156	80+	4000	3,9
Calima S LED1x3800 G154 T840 MPRZ LT92	1203	175	47	3754	22,3	168	80+	4000	3,9
Calima S LED1x4900 G155 T840 MPRZ LT92	1203	175	47	4893	29,8	164	80+	4000	3,9
Calima S LED1x5500 G156 T840 MPRZ LT92	1203	175	47	5457	33,7	162	80+	4000	3,9
Calima S LED1x7600 G158 T840 MPRZ LT92	1203	175	47	7570	46,3	163	80+	4000	3,9
Calima S LED1x3600 G159 T840 MPRZ LT92	1483	175	47	3599	22,6	159	80+	4000	4,8
Calima S LED1x4700 G160 T840 MPRZ LT92	1483	175	47	4693	27,6	170	80+	4000	4,8
Calima S LED1x6150 G161 T840 MPRZ LT92	1483	175	47	6116	37,2	164	80+	4000	4,8
Calima S LED1x6850 G162 T840 MPRZ LT92	1483	175	47	6822	42,6	160	80+	4000	4,8
Calima S LED1x9500 G164 T840 MPRZ LT92	1483	175	47	9463	57,3	165	80+	4000	4,8
Calima S LED2x1450 G165 T840 MPRZ LT92	635	295	47	2879	17,7	163	80+	4000	3,7
Calima S LED2x2100 G166 T840 MPRZ LT92	635	295	47	3989	26,5	151	80+	4000	3,7
Calima S LED2x2750 G167 T840 MPRZ LT92	635	295	47	5457	33,7	162	80+	4000	3,7
Calima S LED2x1450 G168 T840 MPRZ LT92	635	595	47	2879	17,7	163	80+	4000	5,5
Calima S LED2x2100 G169 T840 MPRZ LT92	635	595	47	3989	26,5	151	80+	4000	5,5
Calima S LED2x2750 G170 T840 MPRZ LT92	635	595	47	5457	33,7	162	80+	4000	5,5
Calima S LED3x1450 G171 T840 MPRZ LT92	635	595	47	4319	25,9	167	80+	4000	5,9
Calima S LED3x2000 G172 T840 MPRZ LT92	635	595	47	5983	38,4	156	80+	4000	5,9
Basic version									
Calima S LED1x3550 H137 T840 DPRZ LT80 1G	1203	175	47	3534	26,1	136	80+	4000	3,9
Calima S LED1x5100 H138 T840 DPRZ LT80 1G	1203	175	47	5051	35,5	142	80+	4000	3,9
Calima S LED1x5800 H139 T840 DPRZ LT80	1203	175	47	5785	42,7	135	80+	4000	3,9
Calima S LED1x4450 H140 T840 DPRZ LT80	1483	175	47	4418	31,8	139	80+	4000	4,8
Calima S LED1x6350 H141 T840 DPRZ LT80 1G	1483	175	47	6313	45,4	139	80+	4000	4,8
Calima S LED1x7250 H142 T840 DPRZ LT80	1483	175	47	7231	52,8	137	80+	4000	4,8
Calima S LED1x3800 H137 T840 MPRZ LT92	1203	175	47	3784	26,1	145	80+	4000	3,9
Calima S LED1x5450 H138 T840 MPRZ LT92	1203	175	47	5407	35,5	152	80+	4000	3,9
Calima S LED1x6200 H139 T840 MPRZ LT92	1203	175	47	6193	42,7	145	80+	4000	3,9
Calima S LED1x4750 H140 T840 MPRZ LT92	1483	175	47	4730	31,8	149	80+	4000	4,8
Calima S LED1x6800 H141 T840 MPRZ LT92	1483	175	47	6759	45,4	149	80+	4000	4,8
Calima S LED1x7750 H142 T840 MPRZ LT92	1483	175	47	7742	52,8	147	80+	4000	4,8

*Tolerance range for optical and electrical data: $\pm 10\%$. Values apply to an ambient temperature of 25°C. NORTHCLIFFE LIGHTING is constantly developing and improving its products. The right is reserved to change any product specifications without prior notification

OPTIONS AVAILABLE ON REQUEST:

LED	REFLECTOR AND OPTICS	CONTROL GEAR	SENSORS	EMERGENCY	CONNECTION	COLOUR
T830	DPRZ LT80	DALI	PIR ^{5 6}	EM3	1G ⁵	RAL ⁷
T840	MPRZ LT92	EAIRB-M ^{1 2 3 4 5}		EM3B		
		EAIRB-S ^{2 3 4 5}		EM3A		
		BLT		EM3D		
		TW ⁵				
		BLT TW ⁵				
		COR				
		COR1min				
		COR30min				

- 1 Ingress protection IP20
- 2 Max system size 1x EAIRB-M + 3x EAIRB-S
- 3 Max wire length from EAIRB-M to last EAIRB-S - 11 m
- 4 EAIRB option not applicable for models: G150, G151, G152, G155
- 5 EAIRB, TW, BLT TW, PIR and 1G options not applicable for H series models
- 6 PIR option applicable for models: G165, G166, G167, G168, G169, G170, G171, G172
- 7 Standard colour for luminaire fixing levers is white

DPRZ LT80

MPRZ LT92

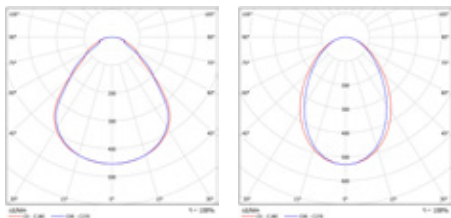

CALIMA U LED

Surface and Suspended Luminares



DESCRIPTION: **Suspended LED luminaire**
Light distribution type: direct (direct/indirect LG3 versions)
Optical system: matt micro-prismatic PMMA diffuser, low glare / translucent micro-prismatic PMMA diffuser
Housing: steel
Colour: white, RAL9003S

GENERAL DATA: **Mains voltage:** 220-240V, 0/50-60Hz, basic version: 220-240V, 50-60Hz
LED lifetime, h: 100000/L80B10, basic version: 50000/L80B10
Protection class IEC: I
Ingress protection code: IP40
Mechanical impact resistance: IK05
Operating temperature range, °C: ta 0...+35

INSTALLATION: Suspended (accessories to be ordered separately), with L/LL option is designed for in-line connection. Push-in terminal, 3x2x2.5mm²

ENVIRONMENT: Indoor

APPLICATION: Office, education, retail, public place



PRODUCT	LENGTH, mm	WIDTH, mm	HEIGHT, mm	LUMINAIRE OUTPUT*, lm	SYSTEM POWER*, W	SYSTEM EFFICACY*, lm/W	CRI	CCT*, K	WEIGHT, kg
Calima U LED1x2700 G173 T840 DPRZ LT80	1215	175	40	2689	18,7	144	80+	4000	4,1
Calima U LED1x3550 G174 T840 DPRZ LT80	1215	175	40	3507	22,3	157	80+	4000	4,1
Calima U LED1x4600 G175 T840 DPRZ LT80	1215	175	40	4570	29,8	153	80+	4000	4,1
Calima U LED1x3400 G176 T840 DPRZ LT80	1495	175	40	3362	22,3	151	80+	4000	5,1
Calima U LED1x4400 G177 T840 DPRZ LT80	1495	175	40	4383	27,3	160	80+	4000	5,1
Calima U LED1x5750 G178 T840 DPRZ LT80	1495	175	40	5713	36,8	155	80+	4000	5,1
Calima U LED1x2900 G173 T840 MPRZ LT92	1215	175	40	2879	18,7	154	80+	4000	4,1
Calima U LED1x3800 G174 T840 MPRZ LT92	1215	175	40	3754	22,3	168	80+	4000	4,1
Calima U LED1x4900 G175 T840 MPRZ LT92	1215	175	40	4893	29,8	164	80+	4000	4,1
Calima U LED1x3600 G176 T840 MPRZ LT92	1495	175	40	3599	22,3	161	80+	4000	5,1
Calima U LED1x4700 G177 T840 MPRZ LT92	1495	175	40	4693	27,3	172	80+	4000	5,1
Calima U LED1x6150 G178 T840 MPRZ LT92	1495	175	40	6116	36,8	166	80+	4000	5,1

PRODUCT	LENGTH, mm	WIDTH, mm	HEIGHT, mm	LUMINAIRE OUTPUT*, lm	SYSTEM POWER*, W	SYSTEM EFFICACY*, lm/W	CRI	CCT*, K	WEIGHT, kg
Calima U LED1x2700/2200 G179 T840 DPRZ LT80 LG3	1215	175	40	4872	29,6	165	80+	4000	4,6
Calima U LED1x4050/3300 G180 T840 DPRZ LT80 LG3	1215	175	40	7309	43,9	167	80+	4000	4,6
Calima U LED1x3400/2950 G181 T840 DPRZ LT80 LG3	1495	175	40	6273	37,6	167	80+	4000	5,6
Calima U LED1x5050/4400 G182 T840 DPRZ LT80 LG3	1495	175	40	9408	56,4	167	80+	4000	5,6
Calima U LED1x2900/2200 G179 T840 MPRZ LT92 LG3	1215	175	40	5062	29,6	171	80+	4000	4,6
Calima U LED1x4350/3300 G180 T840 MPRZ LT92 LG3	1215	175	40	7594	43,9	172	80+	4000	4,6
Calima U LED1x3600/2950 G181 T840 MPRZ LT92 LG3	1495	175	40	6510	37,6	172	80+	4000	5,6
Calima U LED1x5400/4400 G182 T840 MPRZ LT92 LG3	1495	175	40	9764	56,4	172	80+	4000	5,6

Basic version

Calima U LED1x2600 H143 T840 DPRZ LT80	1215	175	40	2570	18,4	140	80+	4000	4,1
Calima U LED1x3550 H144 T840 DPRZ LT80	1215	175	40	3534	25,7	137	80+	4000	4,1
Calima U LED1x5100 H207 T840 DPRZ LT80	1215	175	40	5407	35,5	152	80+	4000	4,1
Calima U LED1x3250 H145 T840 DPRZ LT80	1495	175	40	3213	22,7	141	80+	4000	5,1
Calima U LED1x4450 H146 T840 DPRZ LT80	1495	175	40	4418	31,8	139	80+	4000	5,1
Calima U LED1x6350 H208 T840 DPRZ LT80	1495	175	40	6313	45,4	139	80+	4000	5,1
Calima U LED1x2600/1450 H147 T840 DPRZ LT80 LG3	1215	175	40	3997	26,4	151	80+	4000	4,6
Calima U LED1x3550/1950 H148 T840 DPRZ LT80 LG3	1215	175	40	5447	38,6	141	80+	4000	4,6
Calima U LED1x4300/2100 H209 T840 DPRZ LT80 LG3	1215	175	40	6372	43,4	146	80+	4000	4,6
Calima U LED1x3250/1900 H149 T840 DPRZ LT80 LG3	1495	175	40	5114	33,8	150	80+	4000	5,6
Calima U LED1x4450/2550 H150 T840 DPRZ LT80 LG3	1495	175	40	6968	48,8	142	80+	4000	5,6
Calima U LED1x5400/2800 H210 T840 DPRZ LT80 LG3	1495	175	40	8138	54,2	150	80+	4000	5,6

*Tolerance range for optical and electrical data: ±10%. Values apply to an ambient temperature of 25°C. NORTHCLIFFE LIGHTING is constantly developing and improving its products. The right is reserved to change any product specifications without prior notification

AVAILABLE ACCESSORIES:



Product: I-JOIN MTG KIT Calima U LED v2 RAL9003 (P)
Description: "I" type join kit for connecting luminaires in-line



Product: Suspension MTG KIT SUSY
Description: Suspension wire set "Y" type, 1.5m adjustable, 1pcs
**note - 2pcs MTG KIT SUSY for 1 luminaire required*



Product: CAP cable 3x0.75 2.0m clear
Description: Cable 3x0.75mm² for suspended luminaire up to 2.0 meters, transparent

Product: CAP4, light grey/ white/ black
Description: Square decorative metal cap for hiding cable inlet with suspension wire attachment point, push-in terminals 3x1x1.5mm², light grey/ white/ black



Product: CAP5, light grey/ white/ black
Description: Square decorative metal cap for hiding cable inlet with suspension wire attachment point, push-in terminals 5x1x1.5mm², light grey/ white/ black

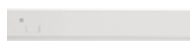

Product: BLANK Calima U LED 300mm 1LIN v2 RAL9003
BLANK Calima U LED 600mm 1LIN v2 RAL9003
BLANK Calima U LED 1215mm 1LIN v2 RAL9003
Description: Blank part kit for connecting luminaires in-line, 1pcs
**note - BLANK through wiring option must meet luminaire option*

OPTIONS AVAILABLE ON REQUEST:

LED	REFLECTOR AND OPTICS	CONTROL GEAR	EMERGENCY	CONNECTION	OTHER	COLOUR
T830	DPRZ LT80	DALI ¹	EM3	1LIN	L ⁸	RAL
T840	MPRZ LT92	EAIRB-M ^{2 3 4 5}	EM3B	3LIN	LL ⁸	
		EAIRB-S ^{3 4 5}	EM3A	CBF3-2.0m clear ⁷		
		BLT	EM3D	CBF5-2.0m clear ⁷		
		TW ⁵	EM3LER ^{5 6}			
		BLT TW ⁵	EM3LOA ^{5 6}			
		COR				
		COR1min				
		COR30min				
		PULL				
		PULLDIM				

- 1 For DALI LIN option wires are 2x0.5mm²
- 2 Ingress protection IP20
- 3 Max system size 1x EAIRB-M + 3x EAIRB-S
- 4 Max wire length from EAIRB-M to last EAIRB-S - 11 m
- 5 EAIRB, TW, BLT TW, EM3LER, EM3LOA options not applicable for H series models
- 6 EM3LER, EM3LOA options not applicable for LG3 models
- 7 For suspended luminaires it is recommended to use one of CBF option for easier mounting
- 8 For L and LL models joint kit not included, 1LIN option included (5TB option for lengths up to 800mm)

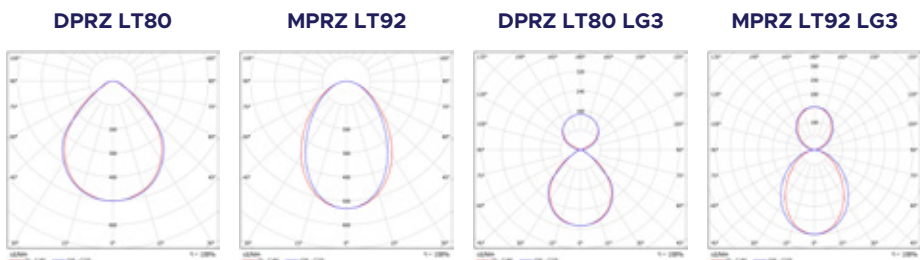

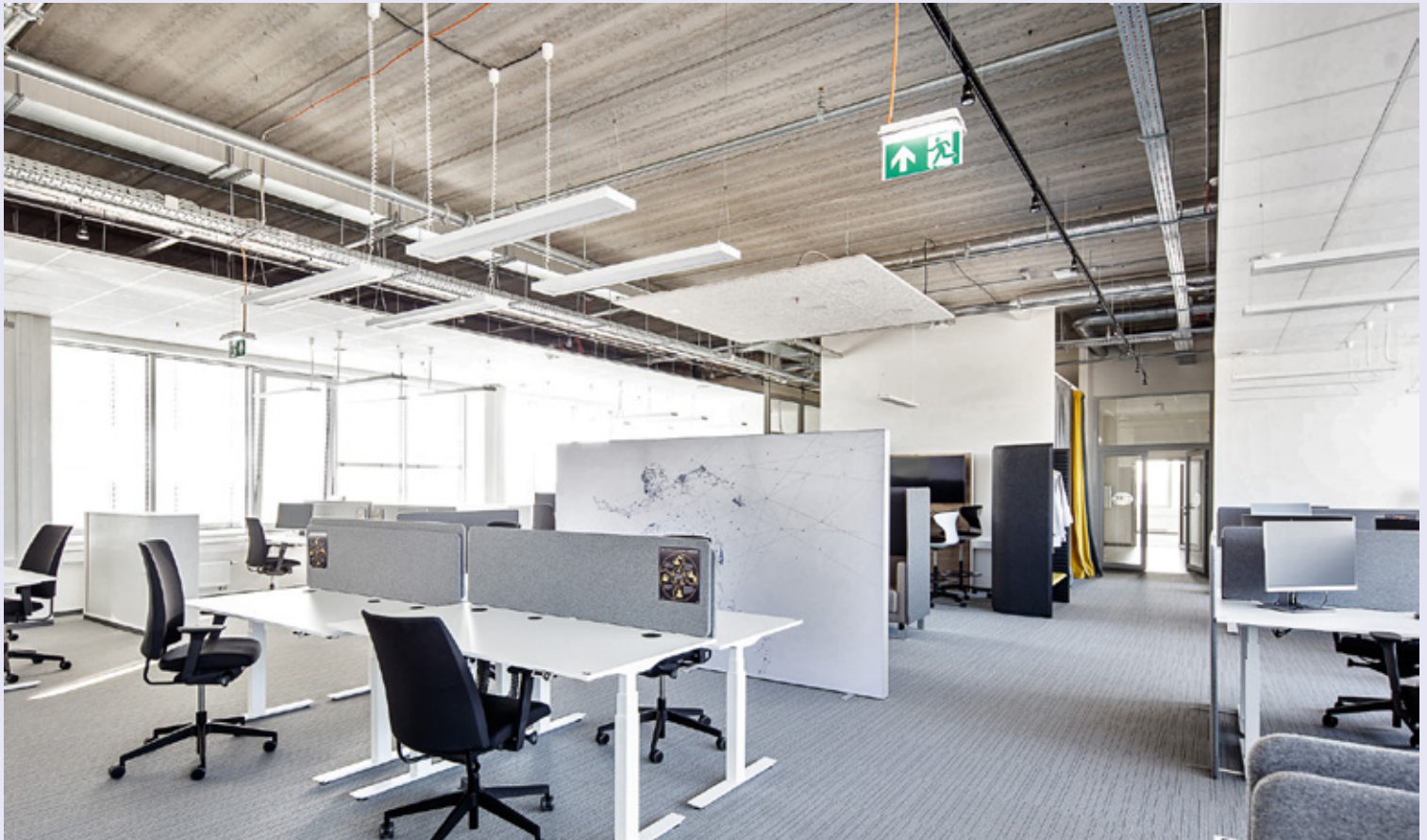

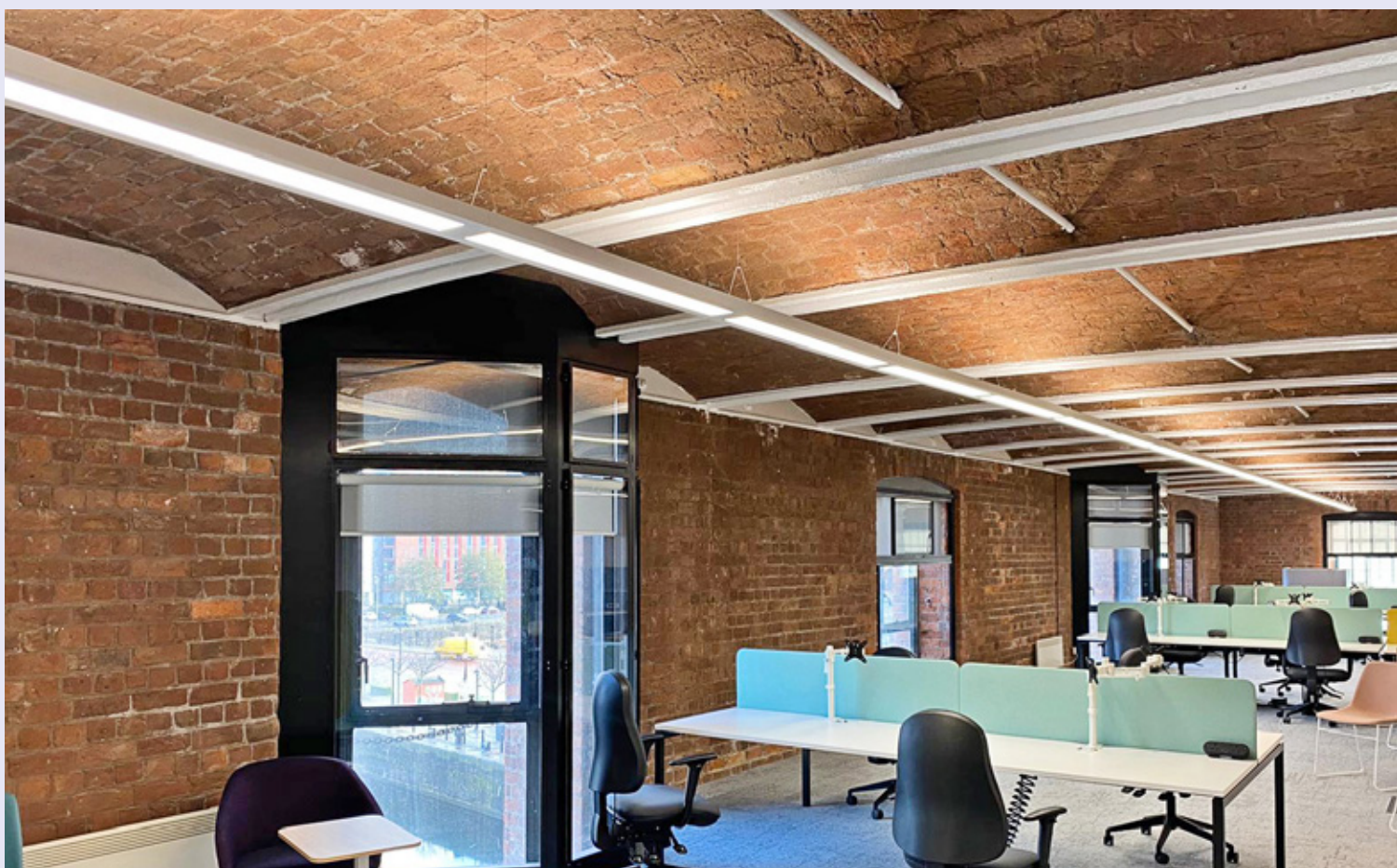
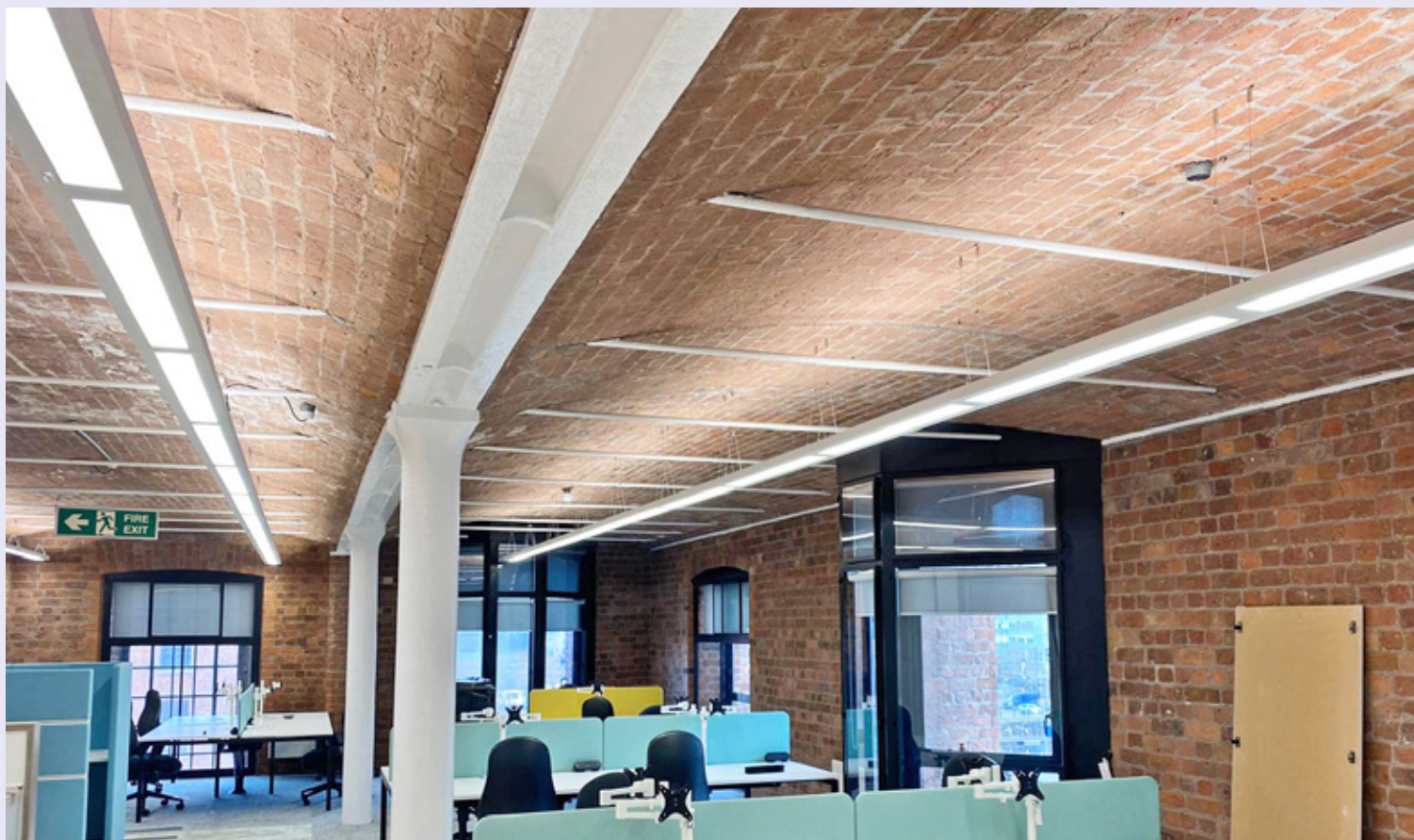

BALI S LED

Surface and Suspended Luminaires

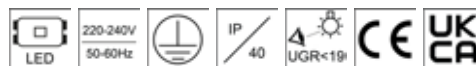

DESCRIPTION: **Surface mounted LED luminaire**
Light distribution type: direct
Optical system: matt micro-prismatic PMMA diffuser, low glare / translucent micro-prismatic PMMA diffuser
Housing: steel
Colour: white, RAL9003S; black, RAL9005S; light grey, RAL9006S

GENERAL DATA: **Mains voltage:** 220-240V, 0/50-60Hz, basic version: 220-240V, 50-60Hz
LED lifetime, h: 50000/L80B10
SDCM: 3
Protection class IEC: I
Ingress protection code: IP40
Mechanical impact resistance: IK05
Operating temperature range, °C: ta 0...+35

INSTALLATION: On the ceiling (mounting brackets included). Push-in terminal, 3x2x2.5mm²

ENVIRONMENT: Indoor

APPLICATION: Office, education, retail, public place



PRODUCT	LENGTH, mm	WIDTH, mm	HEIGHT, mm	LUMINAIRE OUTPUT*, lm	SYSTEM POWER*, W	SYSTEM EFFICACY*, lm/W	CRI	CCT*, K	WEIGHT, kg
Bali S LED1x2400 G255 T840 DPRZ LT80	1136	56	81	2389	18,4	130	80+	4000	2,8
Bali S LED1x3300 G256 T840 DPRZ LT80	1136	56	81	3285	25,8	127	80+	4000	2,8
Bali S LED1x4000 G257 T840 DPRZ LT80	1136	56	81	3982	29,3	136	80+	4000	2,8
Bali S LED1x3000 G258 T840 DPRZ LT80	1416	56	81	2987	22,5	133	80+	4000	3,6
Bali S LED1x4150 G259 T840 DPRZ LT80	1416	56	81	4106	31,8	129	80+	4000	3,6
Bali S LED1x5000 G260 T840 DPRZ LT80	1416	56	81	4978	35,9	139	80+	4000	3,6
Bali S LED1x3600 G261 T840 DPRZ LT80	1696	56	81	3584	26,7	134	80+	4000	4,3
Bali S LED1x4950 G262 T840 DPRZ LT80	1696	56	81	4927	37,3	132	80+	4000	4,3
Bali S LED1x6000 G263 T840 DPRZ LT80	1696	56	81	5973	43,5	137	80+	4000	4,3
Bali S LED1x4200 G264 T840 DPRZ LT80	1976	56	81	4181	30,4	137	80+	4000	5,0
Bali S LED1x5750 G265 T840 DPRZ LT80	1976	56	81	5748	43,6	132	80+	4000	5,0
Bali S LED1x7000 G266 T840 DPRZ LT80	1976	56	81	6969	50,2	139	80+	4000	5,0
Bali S LED1x4800 G267 T840 DPRZ LT80	2256	56	81	4779	34,8	137	80+	4000	5,7
Bali S LED1x6600 G268 T840 DPRZ LT80	2256	56	81	6570	49,3	133	80+	4000	5,7
Bali S LED1x8000 G269 T840 DPRZ LT80	2256	56	81	7964	57,4	139	80+	4000	5,7
Bali S LED1x5400 G270 T840 DPRZ LT80	2536	56	81	5376	39,6	136	80+	4000	6,4
Bali S LED1x7400 G271 T840 DPRZ LT80	2536	56	81	7391	55,4	133	80+	4000	6,4
Bali S LED1x9000 G272 T840 DPRZ LT80	2536	56	81	8960	66,7	134	80+	4000	6,4
Bali S LED1x6000 G273 T840 DPRZ LT80	2816	56	81	5973	43,5	137	80+	4000	7,1
Bali S LED1x8250 G274 T840 DPRZ LT80	2816	56	81	8212	61,6	133	80+	4000	7,1
Bali S LED1x10000 G275 T840 DPRZ LT80	2816	56	81	9955	71,7	139	80+	4000	7,1

PRODUCT Basic version	LENGTH, mm	WIDTH, mm	HEIGHT, mm	LUMINAIRE OUTPUT*, lm	SYSTEM POWER*, W	SYSTEM EFFICACY*, lm/W	CRI	CCT*, K	WEIGHT, kg
Bali S LED1x2400 H151 T840 DPRZ LT80	1136	56	81	2389	17,8	134	80+	4000	2,8
Bali S LED1x3300 H152 T840 DPRZ LT80 1G	1136	56	81	3285	25,2	130	80+	4000	2,8
Bali S LED1x4000 H153 T840 DPRZ LT80	1136	56	81	3982	29,6	135	80+	4000	2,8
Bali S LED1x3000 H154 T840 DPRZ LT80	1416	56	81	2987	22,2	135	80+	4000	3,6
Bali S LED1x4150 H155 T840 DPRZ LT80 1G	1416	56	81	4106	31,5	130	80+	4000	3,6
Bali S LED1x5000 H156 T840 DPRZ LT80	1416	56	81	4978	37,0	135	80+	4000	3,6
Bali S LED1x2600 H151 T840 MPRZ LT92	1136	56	81	2570	17,8	144	80+	4000	2,8
Bali S LED1x3550 H152 T840 MPRZ LT92	1136	56	81	3534	25,2	140	80+	4000	2,8
Bali S LED1x4300 H153 T840 MPRZ LT92	1136	56	81	4285	29,6	145	80+	4000	2,8
Bali S LED1x3250 H154 T840 MPRZ LT92	1416	56	81	3213	22,2	145	80+	4000	3,6
Bali S LED1x4450 H155 T840 MPRZ LT92	1416	56	81	4418	31,5	140	80+	4000	3,6
Bali S LED1x5400 H156 T840 MPRZ LT92	1416	56	81	5356	37,0	145	80+	4000	3,6

*Tolerance range for optical and electrical data: ±10%. Values apply to an ambient temperature of 25°C. NORTHCLIFFE LIGHTING is constantly developing and improving its products. The right is reserved to change any product specifications without prior notification

OPTIONS AVAILABLE ON REQUEST:

LED	REFLECTOR AND OPTICS	CONTROL GEAR	SENSORS	EMERGENCY	CONNECTION	OTHER	COLOUR
T830	DPRZ LT80	DALI	PIR ^{7 8}	EM3	1G	W45 ¹¹	RAL
T840	MPRZ LT92	EAIRB-M ^{1 2 3 4 5 6}	MW ^{9 10}				
		EAIRB-S ^{4 5 6}					
		BLT					
		TW					
		BLT TW					
		COR					
		COR1min					
		COR30min					

- 1 Ingress protection IP20
- 2 For option EAIRB-M luminaire housing is 40mm longer
- 3 The EAIRB sensor is positioned in the end of the luminaire for lengths up to 1800mm, and in the middle of the luminaire for lengths over 1800mm
- 4 Max system size 1x EAIRB-M + 3x EAIRB-S
- 5 Max wire length from EAIRB-M to last EAIRB-S - 11 m
- 6 EAIRB options not applicable for H series models
- 7 For option PIR luminaire housing is 40mm longer
- 8 The PIR sensor is positioned in the end of the luminaire for lengths up to 1800mm, and in the middle of the luminaire for lengths over 1800mm
- 9 With option MW luminaire housing is 40mm longer, and visible part of the sensor is white
- 10 MW is not compatible with W45 option
- 11 Luminaire output with W45 option is 5-7% lower

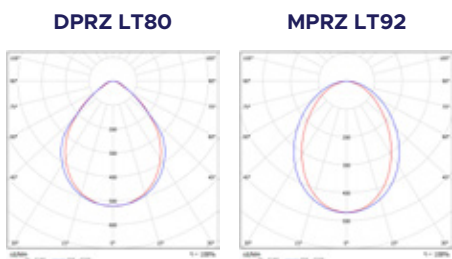

BALI U LED

Surface and Suspended Luminaire

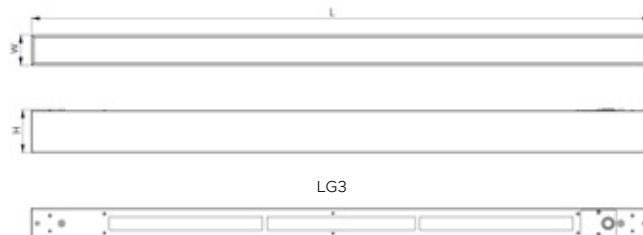
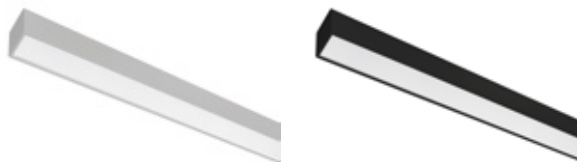
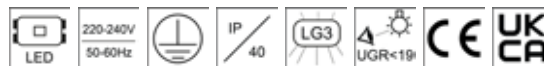

DESCRIPTION: **Suspended LED luminaire**
Light distribution type: direct (optional direct/indirect LG3 versions)
Optical system: matt micro-prismatic PMMA diffuser, low glare / translucent micro-prismatic PMMA diffuser
Housing: steel
Colour: white, RAL9003S; black, RAL9005S; light grey, RAL9006S

GENERAL DATA: **Mains voltage:** 220-240V, 0/50-60Hz
LED lifetime, h: 50000/L80B10
SDCM: 3
Protection class IEC: I
Ingress protection code: IP40
Mechanical impact resistance: IK05
Operating temperature range, °C: ta 0...+35

INSTALLATION: Suspended (wire, cable and cap to be ordered separately). Push-in terminal, 3x2x2.5mm²

ENVIRONMENT: Indoor

APPLICATION: Office, education, retail, public place

PRODUCT	LENGTH, mm	WIDTH, mm	HEIGHT, mm	LUMINAIRE OUTPUT*, lm	SYSTEM POWER*, W	SYSTEM EFFICACY*, lm/W	CRI	CCT*, K	WEIGHT, kg
Bali U LED1x2450 G293 T840 DPRZ LT80	1136	56	68	2411	18,4	131	80+	4000	2,9
Bali U LED1x3300 G294 T840 DPRZ LT80	1136	56	68	3285	25,7	128	80+	4000	2,8
Bali U LED1x4000 G295 T840 DPRZ LT80	1136	56	68	3982	29,3	136	80+	4000	2,8
Bali U LED1x3050 G296 T840 DPRZ LT80	1416	56	68	3013	22,5	134	80+	4000	3,6
Bali U LED1x4150 G297 T840 DPRZ LT80	1416	56	68	4106	31,8	129	80+	4000	3,6
Bali U LED1x5000 G298 T840 DPRZ LT80	1416	56	68	4978	35,9	139	80+	4000	3,6
Bali U LED1x3600 G299 T840 DPRZ LT80	1696	56	68	3584	26,7	134	80+	4000	4,3
Bali U LED1x4950 G300 T840 DPRZ LT80	1696	56	68	4927	37,3	132	80+	4000	4,3
Bali U LED1x6000 G301 T840 DPRZ LT80	1696	56	68	5973	43,5	137	80+	4000	4,3
Bali U LED1x4200 G302 T840 DPRZ LT80	1976	56	68	4181	30,4	137	80+	4000	5,0
Bali U LED1x5750 G303 T840 DPRZ LT80	1976	56	68	5748	43,6	132	80+	4000	5,0
Bali U LED1x7000 G304 T840 DPRZ LT80	1976	56	68	6969	50,2	139	80+	4000	5,0
Bali U LED1x4800 G305 T840 DPRZ LT80	2256	56	68	4779	34,8	137	80+	4000	5,7
Bali U LED1x6600 G306 T840 DPRZ LT80	2256	56	68	6570	49,3	133	80+	4000	5,7
Bali U LED1x8000 G307 T840 DPRZ LT80	2256	56	68	7964	57,4	139	80+	4000	5,7
Bali U LED1x5400 G308 T840 DPRZ LT80	2536	56	68	5376	39,6	136	80+	4000	6,4
Bali U LED1x7400 G309 T840 DPRZ LT80	2536	56	68	7391	55,4	133	80+	4000	6,4
Bali U LED1x9000 G310 T840 DPRZ LT80	2536	56	68	8960	66,7	134	80+	4000	6,4
Bali U LED1x6000 G311 T840 DPRZ LT80	2816	56	68	5973	43,5	137	80+	4000	7,1
Bali U LED1x8250 G312 T840 DPRZ LT80	2816	56	68	8212	61,6	133	80+	4000	7,1
Bali U LED1x10000 G313 T840 DPRZ LT80	2816	56	68	9955	71,7	139	80+	4000	7,1

PRODUCT	LENGTH, mm	WIDTH, mm	HEIGHT, mm	LUMINAIRE OUTPUT*, lm	SYSTEM POWER*, W	SYSTEM EFFICACY*, lm/W	CRI	CCT*, K	WEIGHT, kg
Bali U LED1x2450/1450 G324 T840 DPRZ LT80 LG3	1136	56	77	3815	26,7	142	80+	4000	3,1
Bali U LED1x3050/1900 G325 T840 DPRZ LT80 LG3	1416	56	77	4885	33,4	147	80+	4000	3,9
Bali U LED1x3650/2350 G326 T840 DPRZ LT80 LG3	1696	56	77	5955	40,6	147	80+	4000	4,6
Bali U LED1x4250/2850 G327 T840 DPRZ LT80 LG3	1976	56	77	7026	47,4	149	80+	4000	5,4
Bali U LED1x4850/3300 G328 T840 DPRZ LT80 LG3	2256	56	77	8096	54,0	150	80+	4000	6,1
Bali U LED1x5450/3750 G329 T840 DPRZ LT80 LG3	2536	56	77	9167	62,4	147	80+	4000	6,9
Bali U LED1x6050/4250 G330 T840 DPRZ LT80 LG3	2816	56	77	10237	69,0	149	80+	4000	7,7
Basic version									
Bali U LED1x2600 H172 T840 MPRZ LT92	1136	56	68	2570	17,8	144	80+	4000	2,8
Bali U LED1x3550 H173 T840 MPRZ LT92	1136	56	68	3534	25,2	140	80+	4000	2,8
Bali U LED1x4300 H174 T840 MPRZ LT92	1136	56	68	4285	29,6	145	80+	4000	2,8
Bali U LED1x3250 H175 T840 MPRZ LT92	1416	56	68	3213	22,2	145	80+	4000	3,6
Bali U LED1x4450 H176 T840 MPRZ LT92	1416	56	68	4418	31,5	140	80+	4000	3,6
Bali U LED1x5400 H177 T840 MPRZ LT92	1416	56	68	5356	37,0	145	80+	4000	3,6
Bali U LED1x2450 H172 T840 DPRZ LT80	1136	56	68	2411	17,8	135	80+	4000	2,9
Bali U LED1x3300 H173 T840 DPRZ LT80	1136	56	68	3285	25,2	130	80+	4000	2,8
Bali U LED1x4000 H174 T840 DPRZ LT80	1136	56	68	3982	29,6	135	80+	4000	2,8
Bali U LED1x3050 H175 T840 DPRZ LT80	1416	56	68	3013	22,3	135	80+	4000	3,6
Bali U LED1x4150 H176 T840 DPRZ LT80	1416	56	68	4106	31,5	130	80+	4000	3,6
Bali U LED1x5000 H177 T840 DPRZ LT80	1416	56	68	4978	37,0	135	80+	4000	3,6
Bali U LED1x2450/1450 H129 T840 DPRZ LT80 LG3	1136	56	77	3815	26,7	142	80+	4000	3,1
Bali U LED1x3050/1900 H130 T840 DPRZ LT80 LG3	1416	56	77	4885	33,7	146	80+	4000	3,9

*Tolerance range for optical and electrical data: ±10%. Values apply to an ambient temperature of 25°C. NORTHCLIFFE LIGHTING is constantly developing and improving its products. The right is reserved to change any product specifications without prior notification

AVAILABLE ACCESSORIES:



Product: Suspension MTG KIT SUSI
Description: Suspension wire set "I" type, 1.5m adjustable, 1pcs
**note - 2pcs MTG SUSI KIT for length up to 2000mm, 3pcs MTG SUSI KIT for lengths 2000 - 3000mm*



Product: CAP cable 3x0.75 2.0m clear
Description: Cable 3x0.75mm² for suspended luminaire up to 2.0 meters, transparent



Product: CAP4, light grey/ white/ black
Description: Square decorative metal cap for hiding cable inlet with suspension wire attachment point, push-in terminals 3x1x1.5mm², light grey/ white/ black



Product: CAP cable clip D6.3mm SET clear
Description: Cable and suspension wire clip set, 4pcs. For cable diameter up to 6,3mm and wire diameter 1mm

Product: CAP5, light grey/ white/ black
Description: Square decorative metal cap for hiding cable inlet with suspension wire attachment point, push-in terminals 5x1x1.5mm², light grey/ white/ black

OPTIONS AVAILABLE ON REQUEST:

LED	REFLECTOR AND OPTICS	COVERS	CONTROL GEAR	SENSORS	EMERGENCY	CONNECTION	OTHER	COLOUR
T830	DPRZ LT80	LG3	DALI	MW ^{9 10}	EM3	CBF3-2.0m clear ¹¹	W45 ¹²	RAL
T840	MPRZ LT92		DALIsep ¹	PIR ^{3 4}		CBF5-2.0m clear ¹¹		
			EAIRB-M ^{2 3 4 5 6 7}					
			EAIRB-S ^{5 6 7}					
			BLT					
			TW					
			BLT TW					
			COR					
			COR1min					
			COR30min					
			PULL ⁸					
			PULLDIM ⁸					
			Lsep ¹					

- 1 With LG3 option only
- 2 Ingress protection IP20
- 3 For options EAIRB-M and PIR luminaire housing is 40mm longer
- 4 The EAIRB and PIR sensors are positioned in the end of the luminaire for lengths up to 1800mm, and in the middle of the luminaire for lengths over 1800mm
- 5 Max system size 1x EAIRB-M + 3x EAIRB-S
- 6 Max wire length from EAIRB-M to last EAIRB-S - 11 m
- 7 EAIRB options not applicable for H series models
- 8 For options PULL and PULLDIM luminaire housing is 40mm longer and switch is positioned at the end of luminaire
- 9 With option MW luminaire housing is 40mm longer, and visible part of the sensor is white
- 10 MW is not compatible with W45 option
- 11 It is recommended to use one of CBF option for easier mounting
- 12 Luminaire output with W45 option is 5-7% lower

DPRZ LT80

MPRZ LT92

DPRZ LT80 LG3

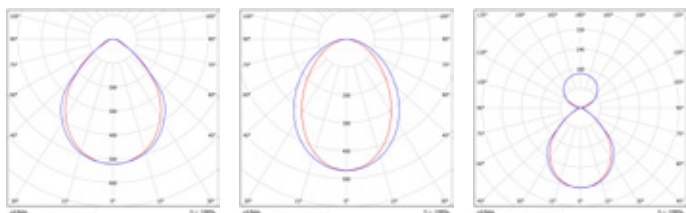



LODOS S LED

Surface and Suspended Luminaires

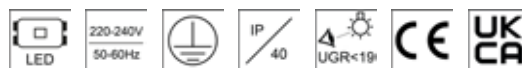

DESCRIPTION: **Surface mounted decorative LED luminaire**
Light distribution type: direct
Optical system: opal PMMA diffuser/ matt micro-prismatic PMMA diffuser, low glare
Housing: steel
Colour: white, RAL9003S

GENERAL DATA: **Mains voltage:** 220-240V, 0/50-60Hz
LED lifetime, h: 50000/L80B10
SDCM: 3
Protection class IEC: I
Ingress protection code: IP40
Mechanical impact resistance: IK02
Operating temperature range, °C: ta 0...+35

INSTALLATION: On the ceiling or suspended (accessories to be ordered separately). Push-in terminal, 3x2x2.5mm²

ENVIRONMENT: Indoor

APPLICATION: Office, education, retail, public place

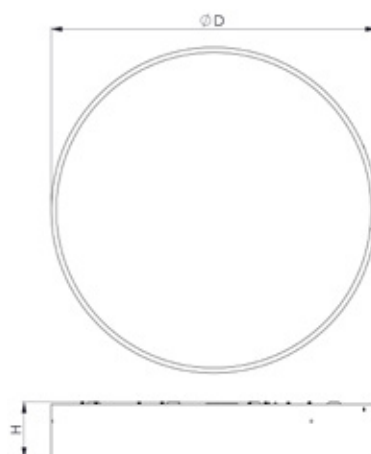

PRODUCT	DIAMETER, mm	HEIGHT, mm	LUMINAIRE OUTPUT*, lm	SYSTEM POWER*, W	SYSTEM EFFICACY*, lm/W	CRI	CCT*, K	WEIGHT, kg
Lodos S LED1x2050 E968 T840 OP LT80	300	100	2009	15,9	126	80+	4000	2,5
Lodos S LED1x2750 E969 T840 OP LT80	300	100	2737	21,4	128	80+	4000	2,5
Lodos S LED1x4100 E970 T840 OP LT80	450	100	4062	30,3	134	80+	4000	4,2
Lodos S LED1x5550 E971 T840 OP LT80	450	100	5520	44,4	124	80+	4000	4,2
Lodos S LED1x6250 E972 T840 OP LT80	600	100	6227	45,0	138	80+	4000	7,5
Lodos S LED1x8600 E973 T840 OP LT80	600	100	8562	63,7	134	80+	4000	7,5
Lodos S LED1x10550 E974 T840 OP LT80	900	114	10530	73,0	144	80+	4000	14,1
Lodos S LED1x13450 E982 T840 OP LT80	900	114	13435	94,1	143	80+	4000	14,1
Lodos S LED1x16550 J249 T840 OP LT80	1140	114	16506	112,0	147	80+	4000	22,8
Lodos S LED1x21100 J250 T840 OP LT80	1140	114	21061	145,9	144	80+	4000	22,8
Lodos S LED1x1800 E968 T840 DPRZ LT80	300	100	1780	15,9	112	80+	4000	2,5
Lodos S LED1x2450 E969 T840 DPRZ LT80	300	100	2425	21,4	113	80+	4000	2,5
Lodos S LED1x3600 E970 T840 DPRZ LT80	450	100	3599	30,3	119	80+	4000	4,2
Lodos S LED1x4900 E971 T840 DPRZ LT80	450	100	4891	44,4	110	80+	4000	4,2
Lodos S LED1x5550 E972 T840 DPRZ LT80	600	100	5518	45,0	123	80+	4000	7,5
Lodos S LED1x7600 E973 T840 DPRZ LT80	600	100	7586	63,7	119	80+	4000	7,5
Lodos S LED1x9350 E974 T840 DPRZ LT80	900	114	9330	73,0	128	80+	4000	14,1
Lodos S LED1x11950 E982 T840 DPRZ LT80	900	114	11904	94,1	127	80+	4000	14,1

*Tolerance range for optical and electrical data: ±10%. Values apply to an ambient temperature of 25°C. NORTHCLIFFE LIGHTING is constantly developing and improving its products. The right is reserved to change any product specifications without prior notification

AVAILABLE ACCESSORIES:



Product: Suspension MTG KIT Bootes C LED / Lodos L LED, white/ grey/ black
Description: Suspension wire set with cap 3x"l" type, 1.5m adjustable, 1pcs



Product: CAP cable 3x0.75 2.0m clear
Description: Cable 3x0.75mm² for suspended luminaire up to 2.0 meters, transparent

OPTIONS AVAILABLE ON REQUEST:

LED	REFLECTOR AND OPTICS	CONTROL GEAR	SENSORS	EMERGENCY	CONNECTION	COLOUR
T830	OP LT80	DALI	MW	EM3	1G	RAL
T840	DPRZ LT80	EAIRB-M ^{1 2 3 4}		EM3B	CBF3-2.0m clear ⁵	
T930		EAIRB-S ^{2 3 4}		EM3A	CBF5-2.0m clear ⁵	
T940		BLT		EM3D		
		COR				
		COR1min				
		COR30min				

1 Ingress protection IP20

2 Max system size 1x EAIR-M + 3x EAIR-S

3 Max wire length from EAIR-M to last EAIR-S - 11 m

4 EAIRB options not applicable for models: E968, E969

5 For suspended luminaires it is recommended to use one of CBF option for easier mounting

OP LT80

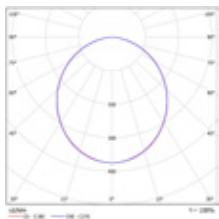

DPRZ LT80

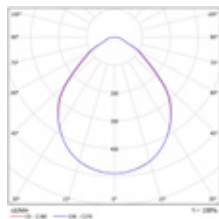



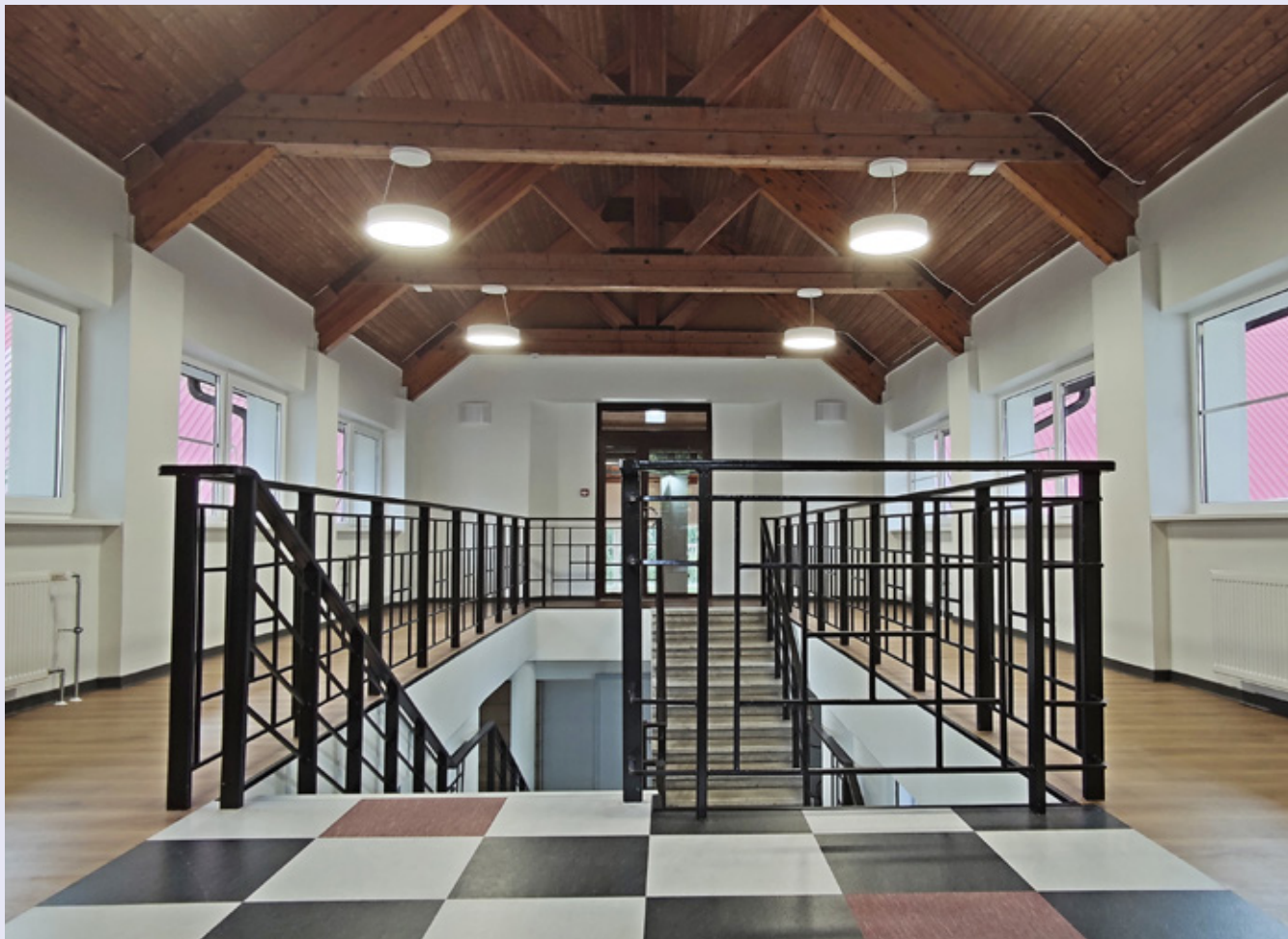

LODOS L LED

Surface and Suspended Luminaires



DESCRIPTION: Low profile decorative circle shaped LED luminaire
Diffuser: opal / matt micro-prismatic PMMA, UV stabilized, low glare
Housing: steel, with quick lock system
Colour: white, RAL9003S

GENERAL DATA: **Mains voltage:** 220-240V, 0/50-60Hz
LED lifetime, h: 50000/L80B10
SDCM: 3
Protection class IEC: I
Ingress protection code: IP40
Mechanical impact resistance: IK02
Operating temperature range, °C: ta 0..+35

INSTALLATION: On the ceiling or suspended (accessories to be ordered separately). Push-in terminal, 3x2x2.5mm²

ENVIRONMENT: Indoor

APPLICATION: Office, education, retail, public place

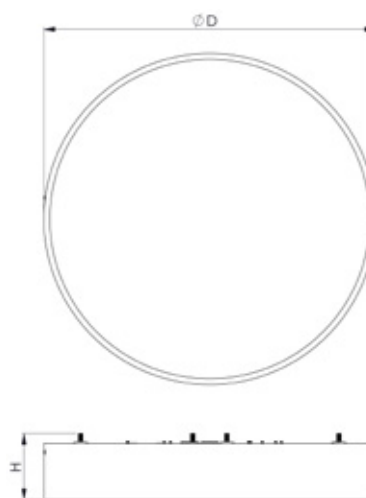

PRODUCT	DIAMETER, mm	HEIGHT, mm	LUMINAIRE OUTPUT*, lm	SYSTEM POWER*, W	SYSTEM EFFICACY*, lm/W	CRI	CCT*, K	WEIGHT, kg
Lodos L LED1x2250 G651 T840 OP LT80	300	77	2227	15,6	143	80+	4000	2,7
Lodos L LED1x2550 G652 T840 OP LT80	300	77	2540	18,0	141	80+	4000	2,7
Lodos L LED1x2900 G653 T840 OP LT80	300	77	2851	20,2	141	80+	4000	2,7
Lodos L LED1x4050 G654 T840 OP LT80	450	77	4011	25,9	155	80+	4000	5,4
Lodos L LED1x4850 G655 T840 OP LT80	450	77	4806	31,0	155	80+	4000	5,4
Lodos L LED1x5600 G656 T840 OP LT80	450	77	5595	36,0	155	80+	4000	5,4
Lodos L LED1x6200 G657 T840 OP LT80	600	77	6157	37,9	163	80+	4000	9,0
Lodos L LED1x7400 G658 T840 OP LT80	600	77	7385	45,7	161	80+	4000	9,0
Lodos L LED1x8650 G659 T840 OP LT80	600	77	8604	52,5	164	80+	4000	9,0
Lodos L LED1x9850 G660 T840 OP LT80	900	87	9821	59,3	166	80+	4000	16,5
Lodos L LED1x11500 G661 T840 OP LT80	900	87	11480	68,7	167	80+	4000	16,5
Lodos L LED1x13150 G662 T840 OP LT80	900	87	13132	79,7	165	80+	4000	16,5
Lodos L LED1x2050 G651 T840 DPRZ LT80	300	77	2010	15,6	129	80+	4000	2,7
Lodos L LED1x2300 G652 T840 DPRZ LT80	300	77	2293	18,0	128	80+	4000	2,7
Lodos L LED1x2600 G653 T840 DPRZ LT80	300	77	2573	20,2	127	80+	4000	2,7
Lodos L LED1x3700 G654 T840 DPRZ LT80	450	77	3684	25,9	142	80+	4000	5,4
Lodos L LED1x4450 G655 T840 DPRZ LT80	450	77	4415	31,0	142	80+	4000	5,4
Lodos L LED1x5150 G656 T840 DPRZ LT80	450	77	5139	36,0	143	80+	4000	5,4
Lodos L LED1x5750 G657 T840 DPRZ LT80	600	77	5737	37,9	152	80+	4000	9,0
Lodos L LED1x6900 G658 T840 DPRZ LT80	600	77	6882	45,7	150	80+	4000	9,0

PRODUCT	DIAMETER, mm	HEIGHT, mm	LUMINAIRE OUTPUT*, lm	SYSTEM POWER*, W	SYSTEM EFFICACY*, lm/W	CRI	CCT*, K	WEIGHT, kg
Lodos L LED1x8050 G659 T840 DPRZ LT80	600	77	8017	52,5	153	80+	4000	9,0
Lodos L LED1x9400 G660 T840 DPRZ LT80	900	87	9375	59,3	158	80+	4000	16,5
Lodos L LED1x11000 G661 T840 DPRZ LT80	900	87	10958	68,7	160	80+	4000	16,5
Lodos L LED1x12550 G662 T840 DPRZ LT80	900	87	12535	79,7	157	80+	4000	16,5

*Tolerance range for optical and electrical data: ±10%. Values apply to an ambient temperature of 25°C. NORTHCLIFFE LIGHTING is constantly developing and improving its products. The right is reserved to change any product specifications without prior notification

AVAILABLE ACCESSORIES:



Product: Suspension MTG KIT Bootes C LED / Lodos L LED, white/ grey/ black
Description: Suspension wire set with cap 3x"1" type, 1.5m adjustable, 1pcs



Product: CAP cable 3x0.75 2.0m clear
Description: Cable 3x0.75mm² for suspended luminaire up to 2.0 meters, transparent



Product: CAP cable clip D6.3mm SET clear
Description: Cable and suspension wire clip set, 4pcs. For cable diameter up to 6,3mm and wire diameter 1mm



Product: CAP4, light grey/ white/ black
Description: Square decorative metal cap for hiding cable inlet with suspension wire attachment point, push-in terminals 3x1x1.5mm², light grey/ white/ black

Product: CAP5, light grey/ white/ black
Description: Square decorative metal cap for hiding cable inlet with suspension wire attachment point, push-in terminals 5x1x1.5mm², light grey/ white/ black

OPTIONS AVAILABLE ON REQUEST:

LED	REFLECTOR AND OPTICS	CONTROL GEAR	SENSORS	EMERGENCY	CONNECTION	COLOUR
T830	OP LT80	DALI	MW	EM3	CBF3-2.0m clear	RAL
T840	DPRZ LT80	EAIRB-M ^{1 2 3 4}		EM3B	CBF3-3.0m clear	
T930		EAIRB-S ^{2 3 4}		EM3A	CBF5-2.0m clear	
T940		BLT		EM3D	CBF5-3.0m clear	
		COR ⁵				
		COR1min ⁵				
		COR30min ⁵				

- 1 For EAIRB-M options ingress protection IP20
- 2 Max system size 1x EAIRB-M + 3x EAIRB-S
- 3 Max wire length from EAIRB-M to last EAIRB-S - 11 m
- 4 EAIRB options not applicable for models: G651, G652, G653
- 5 COR options not applicable for models: G651, G652, G653

OP LT80

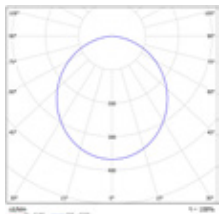

DPRZ LT80

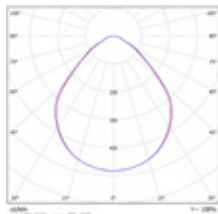

LODOS H LED

Surface and Suspended Luminaires



DESCRIPTION: Suspended decorative LED luminaire with ultra-low appearance
Light distribution type: direct
Optical system: opal PMMA / matt micro-prismatic, UV stabilized diffuser, low glare
Housing: steel
Colour: white, RAL9003S

GENERAL DATA: Mains voltage: 220-240V, 0/50-60Hz
LED lifetime, h: 50000/L80B10
SDCM: 3
Protection class IEC: I
Ingress protection code: IP40
Mechanical impact resistance: IK02
Operating temperature range, °C: ta 0...+35

INSTALLATION: Suspended (accessories to be ordered separately). Push-in terminal, 3x2x2.5mm²

ENVIRONMENT: Indoor

APPLICATION: Office, education, retail, public place

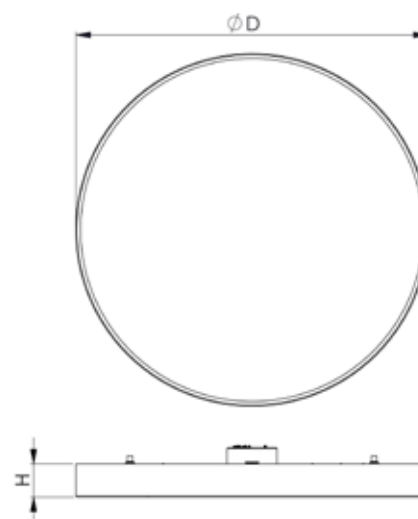

PRODUCT	DIAMETER, mm	HEIGHT, mm	LUMINAIRE OUTPUT*, lm	SYSTEM POWER*, W	SYSTEM EFFICACY*, lm/W	CRI	CCT*, K	WEIGHT, kg
Lodos H LED1x6200 J251 T840 OP LT80	600	56**	6157	37,9	162	80+	4000	5,2
Lodos H LED1x7400 J252 T840 OP LT80	600	56**	7385	45,7	162	80+	4000	5,2
Lodos H LED1x8650 J253 T840 OP LT80	600	56**	8604	52,5	164	80+	4000	5,2
Lodos H LED1x9850 J254 T840 OP LT80	900	61**	9821	59,3	166	80+	4000	9,7
Lodos H LED1x11500 J255 T840 OP LT80	900	61**	11480	68,7	167	80+	4000	9,7
Lodos H LED1x13150 J256 T840 OP LT80	900	61**	13132	79,7	165	80+	4000	9,7
Lodos H LED1x5750 J251 T840 DPRZ LT80	600	56**	5737	37,9	151	80+	4000	5,2
Lodos H LED1x6900 J252 T840 DPRZ LT80	600	56**	6882	45,7	151	80+	4000	5,2
Lodos H LED1x8050 J253 T840 DPRZ LT80	600	56**	8017	52,5	153	80+	4000	5,2
Lodos H LED1x9400 J254 T840 DPRZ LT80	900	61**	9375	59,3	158	80+	4000	9,7
Lodos H LED1x11000 J255 T840 DPRZ LT80	900	61**	10958	68,7	160	80+	4000	9,7
Lodos H LED1x12550 J256 T840 DPRZ LT80	900	61**	12535	79,7	157	80+	4000	9,7

*Tolerance range for optical and electrical data: ±10%. Values apply to an ambient temperature of 25°C. NORTHCLIFFE LIGHTING is constantly developing and improving its products. The right is reserved to change any product specifications without prior notification

**56mm / 61mm are the visual height of the luminaires. With gearbox, luminaire height is 88 / 93mm accordingly

AVAILABLE ACCESSORIES:



Product: Suspension MTG KIT Bootes C LED / Lodos L LED, white/ grey/ black
Description: Suspension wire set with cap 3x1m type, 1.5m adjustable, 1pcs



Product: CAP cable 3x0.75 2.0m clear
Description: Cable 3x0.75mm² for suspended luminaire up to 2.0 meters, transparent



Product: CAP cable clip D6.3mm SET clear
Description: Cable and suspension wire clip set, 4pcs. For cable diameter up to 6,3mm and wire diameter 1mm



Product: CAP4, light grey/ white/ black
Description: Square decorative metal cap for hiding cable inlet with suspension wire attachment point, push-in terminals 3x1x1.5mm², light grey/ white/ black

Product: CAP5, light grey/ white/ black
Description: Square decorative metal cap for hiding cable inlet with suspension wire attachment point, push-in terminals 5x1x1.5mm², light grey/ white/ black

OPTIONS AVAILABLE ON REQUEST:

LED	REFLECTOR AND OPTICS	CONTROL GEAR	CONNECTION	COLOUR
T830	OP LT80	DALI	CBF3-2.0m clear	RAL
T840	DPRZ LT80	EAIRB-M ^{1 2 3}	CBF3-3.0m clear	
		EAIRB-S ^{2 3}	CBF5-2.0m clear	
		BLT	CBF5-3.0m clear	
		COR		
		COR1min		
		COR30min		

1 Ingress protection IP20

2 Max system size 1x EAIRB-M + 3x EAIRB-S

3 Max wire length from EAIRB-M to last EAIRB-S - 11 m

OP LT80

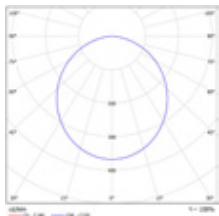

DPRZ LT80

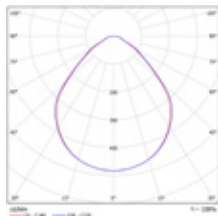

BOOTES C LED

Surface and Suspended Luminaires

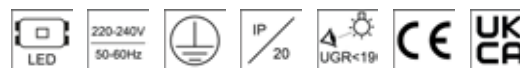

DESCRIPTION: **Surface decorative LED luminaire**
Light distribution type: direct/indirect
Optical system: opal PMMA diffuser / matt micro-prismatic PMMA diffuser, low glare
Housing: steel
Colour: light grey, RAL9006S; white, RAL9003S; black, RAL9005S

GENERAL DATA: **Mains voltage:** 220-240V, 0/50-60Hz
LED lifetime, h: 50000/L80B10
SDCM: 3
Protection class IEC: I
Ingress protection code: IP20
Mechanical impact resistance: IK02
Operating temperature range, °C: ta 0...+35

INSTALLATION: On the ceiling, on the wall or suspended (accessories be ordered separately). Push-in terminal, 3x2x2.5mm²

ENVIRONMENT: Indoor

APPLICATION: Office, education, retail, public place

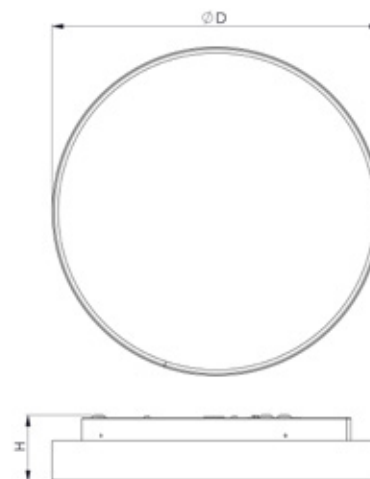

PRODUCT	DIAMETER, mm	HEIGHT, mm	LUMINAIRE OUTPUT*, lm	SYSTEM POWER*, W	SYSTEM EFFICACY*, lm/W	CRI	CCT*, K	WEIGHT, kg
Bootes C LED1x2250 G556 T840 OP	300	92	2227	15,6	143	80+	4000	2,1
Bootes C LED1x2550 G557 T840 OP	300	92	2540	18,0	141	80+	4000	2,1
Bootes C LED1x2900 G558 T840 OP	300	92	2851	20,2	141	80+	4000	2,1
Bootes C LED1x3850 G559 T840 OP	450	92	3824	25,9	148	80+	4000	4,8
Bootes C LED1x4600 G560 T840 OP	450	92	4582	31,0	148	80+	4000	4,8
Bootes C LED1x5350 G561 T840 OP	450	92	5334	36,0	148	80+	4000	4,8
Bootes C LED1x5750 G562 T840 OP	600	92	5737	37,9	152	80+	4000	8,0
Bootes C LED1x6900 G563 T840 OP	600	92	6882	45,7	150	80+	4000	8,0
Bootes C LED1x8050 G564 T840 OP	600	92	8017	52,5	153	80+	4000	8,0
Bootes C LED1x9200 G565 T840 OP	900	92	9152	59,3	154	80+	4000	13,8
Bootes C LED1x10700 G566 T840 OP	900	92	10698	68,7	156	80+	4000	13,8
Bootes C LED1x12250 G567 T840 OP	900	92	12237	79,7	154	80+	4000	13,8
Bootes C LED1x2250 G556 T840 DPRZ LT80	300	92	2010	15,6	129	80+	4000	2,1
Bootes C LED1x2550 G557 T840 DPRZ LT80	300	92	2293	18,0	128	80+	4000	2,1
Bootes C LED1x2900 G558 T840 DPRZ LT80	300	92	2573	20,2	127	80+	4000	2,1
Bootes C LED1x3850 G559 T840 DPRZ LT80	450	92	3451	25,9	133	80+	4000	4,8
Bootes C LED1x4600 G560 T840 DPRZ LT80	450	92	4135	31,0	133	80+	4000	4,8
Bootes C LED1x5350 G561 T840 DPRZ LT80	450	92	4814	36,0	134	80+	4000	4,8
Bootes C LED1x5750 G562 T840 DPRZ LT80	600	92	5178	37,9	137	80+	4000	8,0
Bootes C LED1x6900 G563 T840 DPRZ LT80	600	92	6210	45,7	136	80+	4000	8,0
Bootes C LED1x8050 G564 T840 DPRZ LT80	600	92	7235	52,5	138	80+	4000	8,0
Bootes C LED1x9200 G565 T840 DPRZ LT80	900	92	8259	59,3	139	80+	4000	13,8
Bootes C LED1x10700 G566 T840 DPRZ LT80	900	92	9654	68,7	141	80+	4000	13,8
Bootes C LED1x12250 G567 T840 DPRZ LT80	900	92	11043	79,7	139	80+	4000	13,8

*Tolerance range for optical and electrical data: ±10%. Values apply to an ambient temperature of 25°C. NORTHCLIFFE LIGHTING is constantly developing and improving its products. The right is reserved to change any product specifications without prior notification

AVAILABLE ACCESSORIES:



Product: Suspension MTG KIT SUSI
Description: Suspension wire set "I" type, 1.5m adjustable, 1pcs
**note - 3pcs MTG SUSI KIT for Bootes C LED*



Product: Suspension MTG KIT Bootes C LED / Lodos L LED, white/ grey/ black
Description: Suspension wire set with cap 3x"l" type, 1.5m adjustable, 1pcs



Product: CAP4, light grey/ white/ black
Description: Square decorative metal cap for hiding cable inlet with suspension wire attachment point, push-in terminals 3x1x1.5mm², light grey/ white/ black



Product: CAP cable clip D6.3mm SET clear
Description: Cable and suspension wire clip set, 4pcs. For cable diameter up to 6,3mm and wire diameter 1mm

Product: CAP5, light grey/ white/ black
Description: Square decorative metal cap for hiding cable inlet with suspension wire attachment point, push-in terminals 5x1x1.5mm², light grey/ white/ black

OPTIONS AVAILABLE ON REQUEST:

LED	REFLECTOR AND OPTICS	CONTROL GEAR	SENSOR	EMERGENCY	CONNECTION	OTHER	COLOUR
T830	OP	DALI	MW ⁶	EM3 ⁷	CBF3-2.0m clear	Direct	RAL
T840	DPRZ LT80	EAIRB-M ^{1 2 3 4}		EM3B ⁷	CBF5-2.0m clear		
		EAIRB-S ^{2 3 4}		EM3A ⁷			
		BLT		EM3D ⁷			
		COR ⁵					
		COR1min ⁵					
		COR30min ⁵					

- 1 Ingress protection IP20
- 2 Max system size 1x EAIRB-M + 3x EAIRB-S
- 3 Max wire length from EAIRB-M to last EAIRB-S - 11 m
- 4 EAIRB option not applicable for models: (G556, G557, G558, G559, G560, G561)
- 5 COR options not applicable for models: (G556, G557, G558)
- 6 MW option not applicable for models: (G556, G557, G558)
- 7 EM options not applicable for models: (G556, G557, G558)

OP

DPRZ LT80

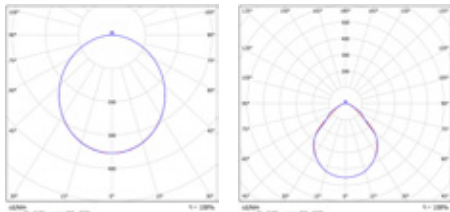



BOOTES Q LED

Surface and Suspended Luminaires



DESCRIPTION: **Surface decorative LED luminaire**
Light distribution type: direct/indirect
Optical system: opal PMMA diffuser / matt micro-prismatic PMMA diffuser, low glare
Housing: steel
Colour: light grey, RAL9006S; white, RAL9003S; black, RAL9005S

GENERAL DATA: **Mains voltage:** 220-240V, 0/50-60Hz
LED lifetime, h: 50000/L80B10
SDCM: 3
Protection class IEC: I
Ingress protection code: IP20
Mechanical impact resistance: IK02
Operating temperature range, °C: ta 0...+35

INSTALLATION: On the ceiling, on the wall or suspended (accessories be ordered separately). Push-in terminal, 3x2x2.5mm²

ENVIRONMENT: Indoor

APPLICATION: Office, education, retail, public place

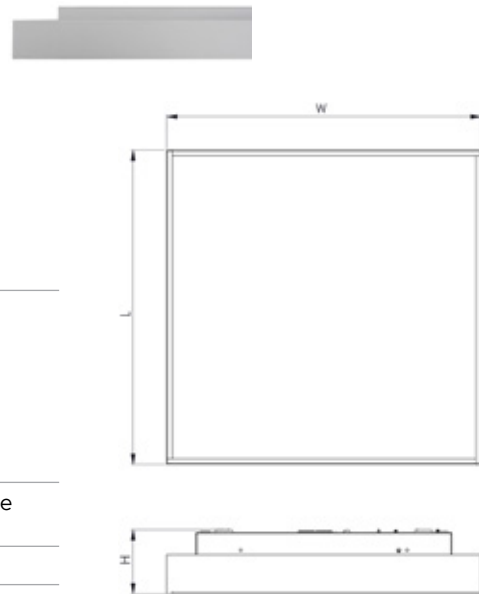

PRODUCT	LENGTH, mm	WIDTH, mm	HEIGHT, mm	LUMINAIRE OUTPUT*, lm	SYSTEM POWER*, W	SYSTEM EFFICACY*, lm/W	CRI	CCT*, K	WEIGHT, kg
Bootes Q LED1x2250 G568 T840 OP	300	300	92	2202	15,4	143	80+	4000	2,7
Bootes Q LED1x2500 G569 T840 OP	300	300	92	2471	17,4	142	80+	4000	2,7
Bootes Q LED1x2750 G570 T840 OP	300	300	92	2738	19,4	141	80+	4000	2,7
Bootes Q LED1x3850 G571 T840 OP	450	450	92	3825	25,8	148	80+	4000	4,9
Bootes Q LED1x4600 G572 T840 OP	450	450	92	4588	30,8	149	80+	4000	4,9
Bootes Q LED1x5350 G573 T840 OP	450	450	92	5345	35,8	149	80+	4000	4,9
Bootes Q LED1x5750 G574 T840 OP	600	600	92	5735	37,7	152	80+	4000	8,7
Bootes Q LED1x6900 G575 T840 OP	600	600	92	6885	45,5	151	80+	4000	8,7
Bootes Q LED1x8050 G576 T840 OP	600	600	92	8027	52,3	153	80+	4000	8,7
Bootes Q LED1x9150 G577 T840 OP	900	900	92	9129	59,1	155	80+	4000	17,4
Bootes Q LED1x10700 G578 T840 OP	900	900	92	10680	68,4	156	80+	4000	17,4
Bootes Q LED1x12250 G579 T840 OP	900	900	92	12226	79,3	154	80+	4000	17,4
Bootes Q LED1x2250 G568 T840 DPRZ LT80	300	300	92	1987	15,4	129	80+	4000	2,7
Bootes Q LED1x2500 G569 T840 DPRZ LT80	300	300	92	2230	17,4	128	80+	4000	2,7
Bootes Q LED1x2750 G570 T840 DPRZ LT80	300	300	92	2471	19,4	127	80+	4000	2,7
Bootes Q LED1x3850 G571 T840 DPRZ LT80	450	450	92	3452	25,8	134	80+	4000	4,9
Bootes Q LED1x4600 G572 T840 DPRZ LT80	450	450	92	4140	30,8	134	80+	4000	4,9
Bootes Q LED1x5350 G573 T840 DPRZ LT80	450	450	92	4823	35,8	135	80+	4000	4,9
Bootes Q LED1x5750 G574 T840 DPRZ LT80	600	600	92	5176	37,7	137	80+	4000	8,7
Bootes Q LED1x6900 G575 T840 DPRZ LT80	600	600	92	6213	45,5	136	80+	4000	8,7
Bootes Q LED1x8050 G576 T840 DPRZ LT80	600	600	92	7244	52,3	139	80+	4000	8,7
Bootes Q LED1x9150 G577 T840 DPRZ LT80	900	900	92	8239	59,1	139	80+	4000	17,4
Bootes Q LED1x10700 G578 T840 DPRZ LT80	900	900	92	9638	68,4	141	80+	4000	17,4
Bootes Q LED1x12250 G579 T840 DPRZ LT80	900	900	92	11033	79,3	139	80+	4000	17,4

*Tolerance range for optical and electrical data: ±10%. Values apply to an ambient temperature of 25°C. NORTHCLIFFE LIGHTING is constantly developing and improving its products. The right is reserved to change any product specifications without prior notification

AVAILABLE ACCESSORIES:



Product: Suspension MTG KIT SUSI
Description: Suspension wire set "I" type, 1.5m adjustable, 1pcs
**note - 4pcs MTG SUSI KIT for Bootes Q LED*



Product: Suspension MTG KIT Bootes Q LED white/ grey/ black
Description: Suspension wire set with cap 4x"1" type, 1.5m adjustable, 1pcs
**note - it is recommend to order with CBF3 or CBF5 option*



Product: CAP4, light grey/ white/ black
Description: Square decorative metal cap for hiding cable inlet with suspension wire attachment point, push-in terminals 3x1x1.5mm², light grey/ white/ black



Product: CAP cable clip D6.3mm SET clear
Description: Cable and suspension wire clip set, 4pcs. For cable diameter up to 6,3mm and wire diameter 1mm

Product: CAP5, light grey/ white/ black
Description: Square decorative metal cap for hiding cable inlet with suspension wire attachment point, push-in terminals 5x1x1.5mm², light grey/ white/ black

OPTIONS AVAILABLE ON REQUEST:

LED	REFLECTOR AND OPTICS	CONTROL GEAR	SENSOR	EMERGENCY	CONNECTION	OTHER	COLOUR
T830	OP	DALI	MW ⁶	EM3 ⁷	CBF3-2.0m clear	Direct	RAL
T840	DPRZ LT80	EAIRB-M ^{1 2 3 4}		EM3B ⁷	CBF5-2.0m clear		
		EAIRB-S ^{2 3 4}		EM3A ⁷			
		BLT		EM3D ⁷			
		COR ⁵					
		COR1min ⁵					
		COR30min ⁵					

- 1 Ingress protection IP20
- 2 Max system size 1x EAIRB-M + 3x EAIRB-S
- 3 Max wire length from EAIRB-M to last EAIRB-S - 11 m
- 4 EAIRB option not applicable for models: (G568, G569, G570)
- 5 COR options not applicable for models: (G568, G569, G570)
- 6 MW option not applicable for models: (G568, G569, G570)
- 7 EM options not applicable for models: (G568, G569, G570)

OP

DPRZ LT80

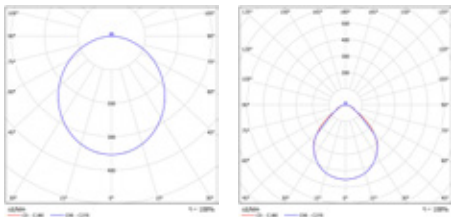

BARBER S LED

Surface and Suspended Luminaires



DESCRIPTION: **Surface mounted LED luminaire**
Light distribution type: direct
Optical system: asymmetrical matt aluminum reflector, opal PMMA diffuser
Housing: steel
Colour: white, RAL9003S

GENERAL DATA: **Mains voltage:** 220-240V, 0/50-60Hz
LED lifetime, h: 50000/L80B10
SDCM: 3
Protection class IEC: I
Ingress protection code: IP40
Mechanical impact resistance: IK02
Operating temperature range, °C: ta 0...+35

INSTALLATION: On the ceiling. Push-in terminal, 3x2x2.5mm²

ENVIRONMENT: Indoor

APPLICATION: Office, education, retail, public place

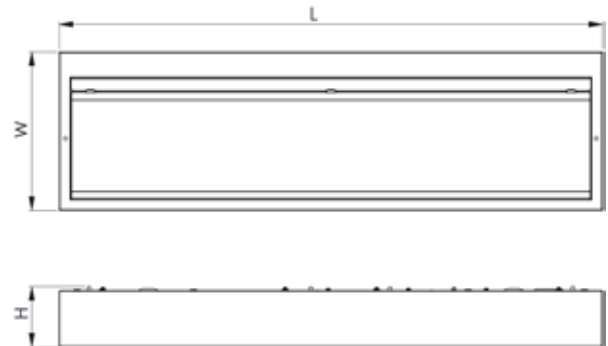

PRODUCT	LENGTH, mm	WIDTH, mm	HEIGHT, mm	LUMINAIRE OUTPUT*, lm	SYSTEM POWER*, W	SYSTEM EFFICACY*, lm/W	CRI	CCT*, K	WEIGHT, kg
Barber S LED1x1550 G878 T840 OP LT80	595	185	60	1518	13,6	111	80+	4000	2,0
Barber S LED1x2100 G879 T840 OP LT80	595	185	60	2086	19,5	107	80+	4000	2,0
Barber S LED1x3050 G880 T840 OP LT80	1195	185	60	3035	25,8	118	80+	4000	3,6
Barber S LED1x4200 G881 T840 OP LT80	1195	185	60	4173	37,8	110	80+	4000	3,6

*Tolerance range for optical and electrical data: ±10%. Values apply to an ambient temperature of 25°C. NORTHCLIFFE LIGHTING is constantly developing and improving its products. The right is reserved to change any product specifications without prior notification

OPTIONS AVAILABLE ON REQUEST:

LED	REFLECTOR AND OPTICS	CONTROL GEAR	EMERGENCY	COLOUR
T830	OP LT80	DALI	EM3	RAL
T840			EM3B	
			EM3A	
			EM3D	

OP LT80

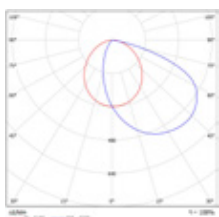

FORMA O LED

Surface and Suspended Luminaires



- DESCRIPTION:** **Decorative ring shaped LED luminaire**
Light distribution: direct
Optical system: opal PMMA diffuser, UV stabilized
Housing: steel
Colour: white, RAL9003S
-
- GENERAL DATA:** **Mains voltage:** 220-240V, 0/50-60Hz
LED lifetime, h: 50000/L80B10
SDCM: 3
Protection class IEC: I
Ingress protection code: IP40
Mechanical impact resistance: IK02
Operating temperature range, °C: ta 0...+35
-
- INSTALLATION:** On the ceiling or suspended (accessories to be ordered separately). Push-in terminal, 3x2x2.5mm²
-
- ENVIRONMENT:** Indoor
-
- APPLICATION:** Office, education, retail, public place

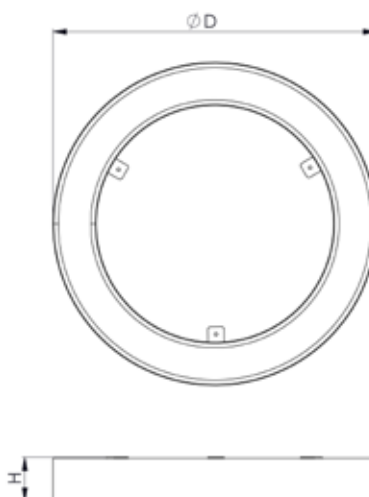

PRODUCT	DIAMETER, mm	HEIGHT, mm	LUMINAIRE OUTPUT*, lm	SYSTEM POWER*, W	SYSTEM EFFICACY*, lm/W	CRI	CCT*, K	WEIGHT, kg
Forma O LED1x2050 J134 T840 OP LT80	600	80	2014	16,9	119	80+	4000	4,6
Forma O LED1x2750 J135 T840 OP LT80	600	80	2744	23,6	116	80+	4000	4,6
Forma O LED1x3800 J136 T840 OP LT80	600	80	3772	34,6	109	80+	4000	4,6
Forma O LED1x3300 J137 T840 OP LT80	900	80	3295	26,4	125	80+	4000	6,8
Forma O LED1x4500 J138 T840 OP LT80	900	80	4491	37,7	119	80+	4000	6,8
Forma O LED1x6200 J139 T840 OP LT80	900	80	6173	54,9	112	80+	4000	6,8
Forma O LED1x4400 J140 T840 OP LT80	1200	80	4394	34,8	126	80+	4000	8,9
Forma O LED1x6000 J141 T840 OP LT80	1200	80	5987	49,8	120	80+	4000	8,9
Forma O LED1x8250 J142 T840 OP LT80	1200	80	8231	72,4	114	80+	4000	8,9

*Tolerance range for optical and electrical data: ±10%. Values apply to an ambient temperature of 25°C. NORTHCLIFFE LIGHTING is constantly developing and improving its products. The right is reserved to change any product specifications without prior notification

AVAILABLE ACCESSORIES:



Product: Suspension MTG KIT SUSI
Description: Suspension wire set "I" type, 1.5m adjustable, 1pcs
**note - at least 3pcs MTG KIT SUSI for one fitting required. For exact quantity please refer to installation manual*



Product: CAP cable 3x0.75 2.0m clear
Description: Cable 3x0.75mm² for suspended luminaire up to 2.0 meters, transparent



Product: Suspension MTG KIT Bootes C LED / Lodos L LED, white/ light grey/ black
Description: Suspension wire set with cap 3x"l" type, 1.5m adjustable, 1pcs
**note - for compatibility with exact product please refer to installation manual*



Product: CAP cable clip D6.3mm SET clear
Description: Cable and suspension wire clip set, 4pcs. For cable diameter up to 6,3mm and wire diameter 1mm



Product: CAP4, light grey/ white/ black
Description: Square decorative metal cap for hiding cable inlet with suspension wire attachment point, push-in terminals 3x1x1.5mm², light grey/ white/ black



Product: CAP5, light grey/ white/ black
Description: Square decorative metal cap for hiding cable inlet with suspension wire attachment point, push-in terminals 5x1x1.5mm², light grey/ white/ black

Product: Surface MTG KIT (Forma O LED) A P9003S

Description: Surface mounting plates for Forma O LED, white steel
**check RAL colour to match luminaire*

OPTIONS AVAILABLE ON REQUEST:

LED	REFLECTOR AND OPTICS	CONTROL GEAR	CONNECTION	COLOUR
T830	OP LT80	DALI	CBF3-2.0m clear	RAL
T840	DPRZ LT80	EAIRB-M ^{1 2 3 4}	CBF3-3.0m clear	
		EAIRB-S ^{3 4}	CBF5-2.0m clear	
		BLT	CBF5-3.0m clear	
		COR		
		COR1min		
		COR30min		

STANDARD

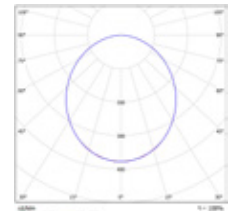

- 1 Ingress protection IP20
- 2 Max system size 1x EAIRB-M + 3x EAIRB-S
- 3 Max wire length from EAIRB-M to last EAIRB-S - 11 m
- 4 EAIRB option not applicable for models: (J134...J136)





FORMA C LED

Surface and Suspended Luminaires



- DESCRIPTION:** **Decorative "C" shaped LED luminaire**
Light distribution: direct
Optical system: opal PMMA diffuser, UV stabilized
Housing: steel
Colour: white, RAL9003S
-
- GENERAL DATA:** **Mains voltage:** 220-240V, 0/50-60Hz
LED lifetime, h: 50000/L80B10
SDCM: 3
Protection class IEC: I
Ingress protection code: IP40
Mechanical impact resistance: IK02
Operating temperature range, °C: ta 0...+35
-
- INSTALLATION:** On the ceiling or suspended (accessories to be ordered separately). Push-in terminal, 3x2x2.5mm²
-
- ENVIRONMENT:** Indoor
-
- APPLICATION:** Office, education, retail, public place

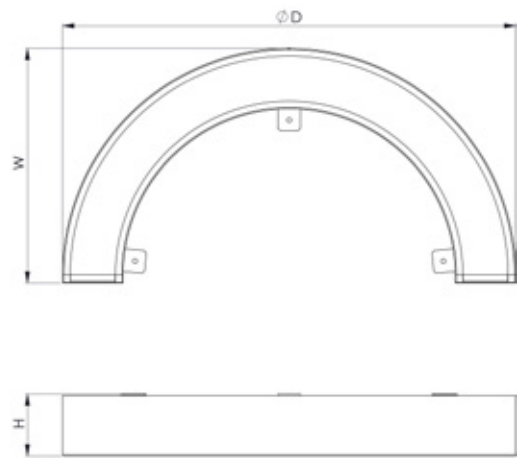

PRODUCT	DIAMETER, mm	WIDTH, mm	HEIGHT, mm	LUMINAIRE OUTPUT*, lm	SYSTEM POWER*, W	SYSTEM EFFICACY*, lm/W	CRI	CCT*, K	WEIGHT, kg
Forma C LED1x1050 J475 T840 OP LT80	600	300	80	1007	8,9	113	80+	4000	2,6
Forma C LED1x1400 J476 T840 OP LT80	600	300	80	1372	12,8	107	80+	4000	2,6
Forma C LED1x1900 J477 T840 OP LT80	600	300	80	1886	18,6	101	80+	4000	2,6
Forma C LED1x1650 J478 T840 OP LT80	900	450	80	1648	14,0	118	80+	4000	3,7
Forma C LED1x2250 J479 T840 OP LT80	900	450	80	2245	20,4	110	80+	4000	3,7
Forma C LED1x3100 J480 T840 OP LT80	900	450	80	3086	30,0	103	80+	4000	3,7
Forma C LED1x2200 J481 T840 OP LT80	1200	600	80	2197	18,4	119	80+	4000	4,7
Forma C LED1x3000 J482 T840 OP LT80	1200	600	80	2994	26,0	115	80+	4000	4,7
Forma C LED1x4150 J483 T840 OP LT80	1200	600	80	4115	37,8	109	80+	4000	4,7

*Tolerance range for optical and electrical data: ±10%. Values apply to an ambient temperature of 25°C. NORTHCLIFFE LIGHTING is constantly developing and improving its products. The right is reserved to change any product specifications without prior notification

AVAILABLE ACCESSORIES:



Product: Suspension MTG KIT SUSI
Description: Suspension wire set "I" type, 1.5m adjustable, 1pcs
**note - at least 3pcs MTG KIT SUSI for one fitting required. For exact quantity please refer to installation manual*



Product: CAP cable 3x0.75 2.0m clear
Description: Cable 3x0.75mm² for suspended luminaire up to 2.0 meters, transparent



Product: CAP4, light grey/ white/ black
Description: Square decorative metal cap for hiding cable inlet with suspension wire attachment point, push-in terminals 3x1x1.5mm², light grey/ white/ black



Product: CAP cable clip D6.3mm SET clear
Description: Cable and suspension wire clip set, 4pcs. For cable diameter up to 6,3mm and wire diameter 1mm



Product: CAP5, light grey/ white/ black
Description: Square decorative metal cap for hiding cable inlet with suspension wire attachment point, push-in terminals 5x1x1.5mm², light grey/ white/ black

Product: Surface MTG KIT (Forma O LED) A P9003S

Description: Surface mounting plates for Forma O LED, white steel
**check RAL colour to match luminaire*

OPTIONS AVAILABLE ON REQUEST:

STANDARD

LED	REFLECTOR AND OPTICS	CONTROL GEAR	CONNECTION	COLOUR
T830	OP LT80	DALI	CBF3-2.0m clear	RAL
T840	DPRZ LT80	BLT	CBF3-3.0m clear	
		COR	CBF5-2.0m clear	
		COR1min	CBF5-3.0m clear	
		COR30min		

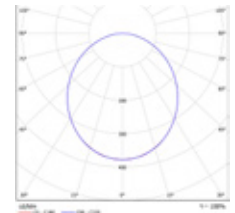

Azure LED

Surface and Suspended Luminaires



- DESCRIPTION:** Surface or suspended LED lightbox
Light distribution: direct
Optical system: soft film, white, low glare
Housing: aluminium
Colour: black, RAL9005
-
- GENERAL DATA:** Mains voltage: 220-240V, 50-60Hz
LED lifetime, h: 50000/L80B20
SDCM: 3
Protection class IEC: I
Ingress protection code: IP40
Mechanical impact resistance: IK02
Operating temperature range, °C: ta -10...+40
-
- INSTALLATION:** Suspended (accessories included). Push-in terminal, 3x2x2.5mm²
-
- ENVIRONMENT:** Indoor
-
- APPLICATION:** Office, hotel, retail, showroom, museum, exhibition, public place

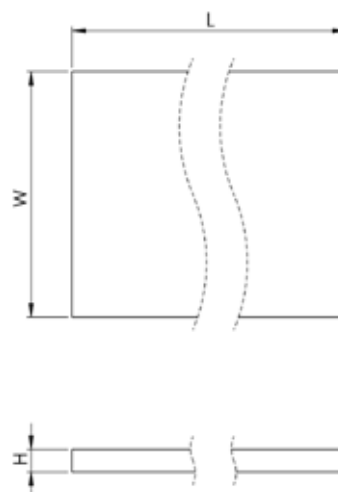

PRODUCT	LENGTH, mm	WIDTH, mm	HEIGHT, mm	LUMINAIRE OUTPUT*, lm	SYSTEM POWER*, W	SYSTEM EFFICACY*, lm/W	CRI	CCT*, K	WEIGHT, kg
Azure LED1x4800 J872 T940 RAL9005	1200	1200	110	4800	60,0	80	90	4000	11,0
Azure LED1x9600 J873 T940 RAL9005	2400	1200	110	9600	120,0	80	90	4000	21,0
Azure LED1x14400 J874 T940 RAL9005	3000	1200	110	14400	180,0	80	90	4000	27,0

*Tolerance range for optical and electrical data: ±10%. Values apply to an ambient temperature of 25°C. NORTHCLIFFE LIGHTING is constantly developing and improving its products. The right is reserved to change any product specifications without prior notification

* Suspension kit is included

AVAILABLE ACCESSORIES:



- Product:** Surface MTG kit Azure series S1200x1200 RAL9005
Description: Surface mounting kit for Azure LED luminaire 1200x1200mm (6pcs), black steel
- Product:** Surface MTG kit Azure series S2400/3000x1200 RAL9005
Description: Surface mounting kit for Azure LED luminaire 2400/3000x1200mm (12pcs), black steel

OPTIONS AVAILABLE ON REQUEST:

LED	CONTROL GEAR
T930	DALI
T940	

STANDARD

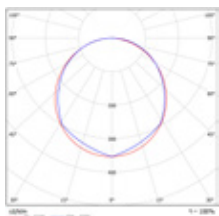

NORTHCLIFFE
making life brighter

ALUMINIUM PROFILE LUMINAIRES

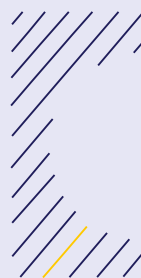

SERPENS S LED

Aluminum Profile Luminaires



DESCRIPTION: Recessed mounted slim profile LED luminaire for in-line connection
Light distribution type: direct
Optical system: opal polycarbonate diffuser
Housing: aluminium
Colour: white, RAL9003S

GENERAL DATA: Mains voltage: 220-240V, 0/50-60Hz
 LED lifetime, h: 50000/L80B10
 SDCM: 3
 Protection class IEC: I
 Ingress protection code: IP40
 Mechanical impact resistance: IK05
 Glow wire test, °C: 650
 Operating temperature range, °C: ta 0...+35

INSTALLATION: In ceilings with cut-out openings (mounting brackets included), with L/LL option is designed for in-line connection. Push-in terminal, 3x2x2.5mm²

ENVIRONMENT: Indoor

APPLICATION: Office, education, hotel, corridor, retail, public place



PRODUCT	LENGTH, mm	WIDTH, mm	HEIGHT, mm	CUT-OUT, mm	LUMINAIRE OUTPUT*, lm	SYSTEM POWER*, W	SYSTEM EFFICACY*, lm/W	CRI	CCT*, K	WEIGHT, kg
Serpens S LED1x650 G366 T840 OP LO1 SB	595	55	75	583x45	610	6,8	90	80+	4000	1,5
Serpens S LED1x850 G367 T840 OP LO2 SB	595	55	75	583x45	832	9,6	86	80+	4000	1,5
Serpens S LED1x1150 G368 T840 OP LO3 SB	595	55	75	583x45	1143	13,3	86	80+	4000	1,5
Serpens S LED1x1750 J861 T840 OP LO4 SB	595	55	75	583x45	1715	18,9	91	80+	4000	1,5
Serpens S LED1x950 G369 T840 OP LO1 SB	875	55	75	863x45	916	10,1	90	80+	4000	2,0
Serpens S LED1x1250 G370 T840 OP LO2 SB	875	55	75	863x45	1247	13,6	91	80+	4000	2,0
Serpens S LED1x1750 G371 T840 OP LO3 SB	875	55	75	863x45	1715	18,9	91	80+	4000	2,0
Serpens S LED1x2600 J862 T840 OP LO4 SB	875	55	75	863x45	2572	28,7	90	80+	4000	2,0
Serpens S LED1x1250 G372 T840 OP LO1 SB	1155	55	75	1143x45	1220	12,7	96	80+	4000	2,7
Serpens S LED1x1700 G373 T840 OP LO2 SB	1155	55	75	1143x45	1663	17,1	97	80+	4000	2,7
Serpens S LED1x2300 G374 T840 OP LO3 SB	1155	55	75	1143x45	2286	24,7	93	80+	4000	2,7
Serpens S LED1x3450 J863 T840 OP LO4 SB	1155	55	75	1143x45	3430	38,6	89	80+	4000	2,7
Serpens S LED1x1550 G375 T840 OP LO1 SB	1435	55	75	1423x45	1526	15,9	96	80+	4000	3,2
Serpens S LED1x2100 G376 T840 OP LO2 SB	1435	55	75	1423x45	2079	21,4	97	80+	4000	3,2
Serpens S LED1x2900 G377 T840 OP LO3 SB	1435	55	75	1423x45	2858	30,8	93	80+	4000	3,2
Serpens S LED1x4300 J864 T840 OP LO4 SB	1435	55	75	1423x45	4287	47,8	90	80+	4000	3,2
Serpens S LED1x1850 G378 T840 OP LO1 SB	1715	55	75	1703x45	1831	18,0	102	80+	4000	3,7
Serpens S LED1x2500 G379 T840 OP LO2 SB	1715	55	75	1703x45	2495	25,2	99	80+	4000	3,7
Serpens S LED1x3450 G380 T840 OP LO3 SB	1715	55	75	1703x45	3430	37,0	93	80+	4000	3,7
Serpens S LED1x5150 J865 T840 OP LO4 SB	1715	55	75	1703x45	5144	56,7	91	80+	4000	3,7

PRODUCT	LENGTH, mm	WIDTH, mm	HEIGHT, mm	CUT-OUT, mm	LUMINAIRE OUTPUT*, lm	SYSTEM POWER*, W	SYSTEM EFFICACY*, lm/W	CRI	CCT*, K	WEIGHT, kg
Serpens S LED1x2150 G381 T840 OP LO1 SB	1995	55	75	1985x45	2136	21,0	102	80+	4000	4,4
Serpens S LED1x2950 G382 T840 OP LO2 SB	1995	55	75	1985x45	2911	29,3	99	80+	4000	4,4
Serpens S LED1x4050 G383 T840 OP LO3 SB	1995	55	75	1985x45	4001	43,2	93	80+	4000	4,4
Serpens S LED1x6450 J866 T840 OP LO4 SB	1995	55	75	1985x45	6430	70,1	92	80+	4000	4,4
Serpens S LED1x2450 G581 T840 OP LO1 SB	2275	55	75	2263x45	2441	23,5	104	80+	4000	4,6
Serpens S LED1x3350 G582 T840 OP LO2 SB	2275	55	75	2263x45	3326	33,6	99	80+	4000	4,6
Serpens S LED1x4600 G583 T840 OP LO3 SB	2275	55	75	2263x45	4573	48,7	94	80+	4000	4,6
Serpens S LED1x6900 J867 T840 OP LO4 SB	2275	55	75	2263x45	6859	77,3	89	80+	4000	4,6
Serpens S LED1x2750 G584 T840 OP LO1 SB	2555	55	75	2543x45	2746	26,4	104	80+	4000	5,1
Serpens S LED1x3750 G585 T840 OP LO2 SB	2555	55	75	2543x45	3742	37,7	99	80+	4000	5,1
Serpens S LED1x5150 G586 T840 OP LO3 SB	2555	55	75	2543x45	5144	54,8	94	80+	4000	5,1
Serpens S LED1x7750 J868 T840 OP LO4 SB	2555	55	75	2543x45	7716	83,2	93	80+	4000	5,1
Serpens S LED1x3250 G587 T840 OP LO1 SB	2975	55	75	2963x45	3204	30,9	104	80+	4000	6,0
Serpens S LED1x4400 G588 T840 OP LO2 SB	2975	55	75	2963x45	4366	44,0	99	80+	4000	6,0
Serpens S LED1x6050 G589 T840 OP LO3 SB	2975	55	75	2963x45	6001	64,0	94	80+	4000	6,0

*Tolerance range for optical and electrical data: ±10%. Values apply to an ambient temperature of 25°C. NORTHCLIFFE LIGHTING is constantly developing and improving its products. The right is reserved to change any product specifications without prior notification

AVAILABLE ACCESSORIES:



Product: Panel removal tool
Description: A pair of Serpens S / Decor S panel removal tools for neat panel removal during installation

OPTIONS AVAILABLE ON REQUEST:

LED	CONTROL GEAR	EMERGENCY	CONNECTION	OTHER	COLOUR
T830	DALI ¹	EM3 ²	1LIN ³	L ⁴ 5	RAL
T840	BLT	EM3B ²	2LIN ³	LL ⁴ 6	
		EM3A ²	3LIN ³		
		EM3D ²	2G		

- 1 For DALI LIN option wires are 2x0.5mm²
- 2 EM options applicable for models longer than 1000mm
- 3 LIN options applicable for models longer than 800mm, for shorter models 5 pole terminal block included as standard
- 4 For L and LL models joint kit and 1LIN option included (5TB option for lengths up to 800mm)
- 5 First/end luminaire, body is 16mm shorter than standalone version
- 6 In-line luminaire, body is 32mm shorter than standalone version

OP

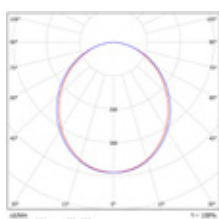





SERPENS LED

Aluminum Profile Luminaires

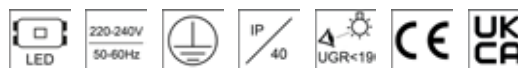

DESCRIPTION: **A recessed medium profile LED luminaire for in-line connection**
Light distribution type: direct
Optical system: opal polycarbonate diffuser / matt micro-prismatic polycarbonate diffuser, low glare
Housing: aluminium
Colour: white, RAL9003S

GENERAL DATA: **Mains voltage:** 220-240V, 0/50-60Hz
LED lifetime, h: 50000/L80B10
SDCM: 3
Protection class IEC: I
Ingress protection code: IP40 (IP44 optional)
Mechanical impact resistance: IK05
Glow wire test, °C: 650
Operating temperature range, °C: ta -15...+35

INSTALLATION: In ceilings with cut-out openings (mounting brackets included), with L/LL option is designed for in-line connection. Push-in terminal, 3x2x2.5mm²

ENVIRONMENT: Indoor

APPLICATION: Office, education, hotel, corridor, retail, public place



PRODUCT	LENGTH, mm	WIDTH, mm	HEIGHT, mm	CUT-OUT, mm	LUMINAIRE OUTPUT*, lm	SYSTEM POWER*, W	SYSTEM EFFICACY*, lm/W	CRI	CCT*, K	WEIGHT, kg
Serpens LED1x850 G183 T840 OP LO1 SB	592	77	68	582x68	803	6,8	119	80+	4000	1,5
Serpens LED1x1100 G184 T840 OP LO2 SB	592	77	68	582x68	1095	9,6	114	80+	4000	1,5
Serpens LED1x1550 G185 T840 OP LO3 SB	592	77	68	582x68	1505	13,3	113	80+	4000	1,5
Serpens LED1x2300 J662 T840 OP LO4 SB	592	77	68	582x68	2258	18,9	119	80+	4000	1,5
Serpens LED1x1250 G186 T840 OP LO1 SB	872	77	68	862x68	1206	10,1	119	80+	4000	2,0
Serpens LED1x1650 G187 T840 OP LO2 SB	872	77	68	862x68	1642	13,6	120	80+	4000	2,0
Serpens LED1x2300 G188 T840 OP LO3 SB	872	77	68	862x68	2258	18,9	120	80+	4000	2,0
Serpens LED1x3400 J663 T840 OP LO4 SB	872	77	68	862x68	3387	28,7	118	80+	4000	2,0
Serpens LED1x1650 G189 T840 OP LO1 SB	1152	77	68	1142x68	1607	12,7	126	80+	4000	2,5
Serpens LED1x2200 G190 T840 OP LO2 SB	1152	77	68	1142x68	2190	17,1	128	80+	4000	2,5
Serpens LED1x3050 G191 T840 OP LO3 SB	1152	77	68	1142x68	3010	24,7	122	80+	4000	2,5
Serpens LED1x4550 J664 T840 OP LO4 SB	1152	77	68	1142x68	4516	38,6	117	80+	4000	2,5
Serpens LED1x2050 G192 T840 OP LO1 SB	1432	77	68	1422x68	2009	15,9	126	80+	4000	2,9
Serpens LED1x2750 G193 T840 OP LO2 SB	1432	77	68	1422x68	2737	21,4	128	80+	4000	2,9
Serpens LED1x3800 G194 T840 OP LO3 SB	1432	77	68	1422x68	3763	30,8	122	80+	4000	2,9
Serpens LED1x5650 J665 T840 OP LO4 SB	1432	77	68	1422x68	5645	47,8	118	80+	4000	2,9
Serpens LED1x2450 G195 T840 OP LO1 SB	1712	77	68	1702x68	2410	18,0	134	80+	4000	3,4
Serpens LED1x3300 G196 T840 OP LO2 SB	1712	77	68	1702x68	3285	25,2	130	80+	4000	3,4
Serpens LED1x4550 G197 T840 OP LO3 SB	1712	77	68	1702x68	4516	37,0	122	80+	4000	3,4
Serpens LED1x6800 J666 T840 OP LO4 SB	1712	77	68	1702x68	6773	56,7	119	80+	4000	3,4
Serpens LED1x2850 G198 T840 OP LO1 SB	1992	77	68	1982x68	2812	21,0	134	80+	4000	4,0
Serpens LED1x3850 G199 T840 OP LO2 SB	1992	77	68	1982x68	3832	29,3	131	80+	4000	4,0

PRODUCT	LENGTH, mm	WIDTH, mm	HEIGHT, mm	CUT-OUT, mm	LUMINAIRE OUTPUT*, lm	SYSTEM POWER*, W	SYSTEM EFFICACY*, lm/W	CRI	CCT*, K	WEIGHT, kg
Serpens LED1x5300 G200 T840 OP LO3 SB	1992	77	68	1982x68	5268	43,2	122	80+	4000	4,0
Serpens LED1x8500 J667 T840 OP LO4 SB	2132	77	68	2122x68	8466	70,1	121	80+	4000	4,2
Serpens LED1x3250 G201 T840 OP LO1 SB	2272	77	68	2262x68	3214	23,5	137	80+	4000	4,3
Serpens LED1x4400 G202 T840 OP LO2 SB	2272	77	68	2262x68	4380	33,6	130	80+	4000	4,3
Serpens LED1x6050 G203 T840 OP LO3 SB	2272	77	68	2262x68	6021	48,7	124	80+	4000	4,3
Serpens LED1x9050 J668 T840 OP LO4 SB	2272	77	68	2262x68	9030	77,3	117	80+	4000	4,3
Serpens LED1x3650 G204 T840 OP LO1 SB	2552	77	68	2542x68	3616	26,4	137	80+	4000	5,4
Serpens LED1x4950 G205 T840 OP LO2 SB	2552	77	68	2542x68	4927	37,7	131	80+	4000	5,4
Serpens LED1x6800 G206 T840 OP LO3 SB	2552	77	68	2542x68	6773	54,8	124	80+	4000	5,4
Serpens LED1x10200 J669 T840 OP LO4 SB	2552	77	68	2542x68	10159	83,2	122	80+	4000	5,4
Serpens LED1x4250 G207 T840 OP LO1 SB	2972	77	68	2962x68	4219	30,9	137	80+	4000	5,8
Serpens LED1x5750 G208 T840 OP LO2 SB	2972	77	68	2962x68	5748	44,0	131	80+	4000	5,8
Serpens LED1x7950 G209 T840 OP LO3 SB	2972	77	68	2962x68	7902	64,0	124	80+	4000	5,8
Serpens LED1x750 G183 T840 DPRZ LT80 LO1 SB	592	77	68	582x68	702	6,8	104	80+	4000	1,5
Serpens LED1x1000 G184 T840 DPRZ LT80 LO2 SB	592	77	68	582x68	956	9,6	99	80+	4000	1,5
Serpens LED1x1350 G185 T840 DPRZ LT80 LO3 SB	592	77	68	582x68	1314	13,3	99	80+	4000	1,5
Serpens LED1x2000 J662 T840 DPRZ LT80 LO4 SB	592	77	68	582x68	1972	18,9	104	80+	4000	1,5
Serpens LED1x1100 G186 T840 DPRZ LT80 LO1 SB	872	77	68	862x68	1053	10,1	104	80+	4000	2,0
Serpens LED1x1450 G187 T840 DPRZ LT80 LO2 SB	872	77	68	862x68	1435	13,6	105	80+	4000	2,0
Serpens LED1x2000 G188 T840 DPRZ LT80 LO3 SB	872	77	68	862x68	1972	18,9	104	80+	4000	2,0
Serpens LED1x3000 J663 T840 DPRZ LT80 LO4 SB	872	77	68	862x68	2958	28,7	103	80+	4000	2,0
Serpens LED1x1450 G189 T840 DPRZ LT80 LO1 SB	1152	77	68	1142x68	1403	12,7	110	80+	4000	2,5
Serpens LED1x1950 G190 T840 DPRZ LT80 LO2 SB	1152	77	68	1142x68	1913	17,1	112	80+	4000	2,5
Serpens LED1x2650 G191 T840 DPRZ LT80 LO3 SB	1152	77	68	1142x68	2629	24,7	107	80+	4000	2,5
Serpens LED1x3950 J664 T840 DPRZ LT80 LO4 SB	1152	77	68	1142x68	3944	38,6	102	80+	4000	2,5
Serpens LED1x1800 G192 T840 DPRZ LT80 LO1 SB	1432	77	68	1422x68	1755	15,9	110	80+	4000	2,9
Serpens LED1x2400 G193 T840 DPRZ LT80 LO2 SB	1432	77	68	1422x68	2391	21,4	111	80+	4000	2,9
Serpens LED1x3300 G194 T840 DPRZ LT80 LO3 SB	1432	77	68	1422x68	3286	30,8	107	80+	4000	2,9
Serpens LED1x4950 J665 T840 DPRZ LT80 LO4 SB	1432	77	68	1422x68	4930	47,8	103	80+	4000	2,9
Serpens LED1x2150 G195 T840 DPRZ LT80 LO1 SB	1712	77	68	1702x68	2105	18,0	117	80+	4000	3,4
Serpens LED1x2900 G196 T840 DPRZ LT80 LO2 SB	1712	77	68	1702x68	2869	25,2	114	80+	4000	3,4
Serpens LED1x3950 G197 T840 DPRZ LT80 LO3 SB	1712	77	68	1702x68	3944	37,0	107	80+	4000	3,4
Serpens LED1x5950 J666 T840 DPRZ LT80 LO4 SB	1712	77	68	1702x68	5915	56,7	104	80+	4000	3,4
Serpens LED1x2500 G198 T840 DPRZ LT80 LO1 SB	1992	77	68	1982x68	2456	21,0	117	80+	4000	4,0
Serpens LED1x3350 G199 T840 DPRZ LT80 LO2 SB	1992	77	68	1982x68	3347	29,3	114	80+	4000	4,0
Serpens LED1x4650 G200 T840 DPRZ LT80 LO3 SB	1992	77	68	1982x68	4601	43,2	107	80+	4000	4,0
Serpens LED1x7400 J667 T840 DPRZ LT80 LO4 SB	2132	77	68	2122x68	7395	70,1	105	80+	4000	4,2
Serpens LED1x2850 G201 T840 DPRZ LT80 LO1 SB	2272	77	68	2262x68	2807	23,5	120	80+	4000	4,3
Serpens LED1x3850 G202 T840 DPRZ LT80 LO2 SB	2272	77	68	2262x68	3825	33,6	114	80+	4000	4,3
Serpens LED1x5300 G203 T840 DPRZ LT80 LO3 SB	2272	77	68	2262x68	5258	48,7	108	80+	4000	4,3
Serpens LED1x7900 J668 T840 DPRZ LT80 LO4 SB	2272	77	68	2262x68	7887	77,3	102	80+	4000	4,3
Serpens LED1x3200 G204 T840 DPRZ LT80 LO1 SB	2552	77	68	2542x68	3158	26,4	120	80+	4000	5,4
Serpens LED1x4350 G205 T840 DPRZ LT80 LO2 SB	2552	77	68	2542x68	4304	37,7	114	80+	4000	5,4
Serpens LED1x5950 G206 T840 DPRZ LT80 LO3 SB	2552	77	68	2542x68	5915	54,8	108	80+	4000	5,4
Serpens LED1x8900 J669 T840 DPRZ LT80 LO4 SB	2552	77	68	2542x68	8873	83,2	107	80+	4000	5,4
Serpens LED1x3700 G207 T840 DPRZ LT80 LO1 SB	2972	77	68	2962x68	3685	30,9	119	80+	4000	5,8
Serpens LED1x5050 G208 T840 DPRZ LT80 LO2 SB	2972	77	68	2962x68	5020	44,0	114	80+	4000	5,8
Serpens LED1x6950 G209 T840 DPRZ LT80 LO3 SB	2972	77	68	2962x68	6901	64,0	108	80+	4000	5,8

*Tolerance range for optical and electrical data: ±10%. Values apply to an ambient temperature of 25°C. NORTHCLIFFE LIGHTING is constantly developing and improving its products. The right is reserved to change any product specifications without prior notification

AVAILABLE ACCESSORIES:



Product: BLANK Serpens LED L1000mm LL RAL9003S
Description: Blank part kit for connecting luminaires in-line 1000mm long, 1pcs
**note - indicate length, location and RAL colour before placing order*
**note - BLANK through wiring option must meet luminaire options*

OPTIONS AVAILABLE ON REQUEST:

LED	REFLECTOR AND OPTICS	CONTROL GEAR	SENSORS	EMERGENCY	CONNECTION	OTHER	PROTECTION	COLOUR
T830	OP	DALI ¹	MW ^{5 8}	EM3 ^{11 12}	1LIN ¹³	L ^{14 15}	IP44 ¹⁷	RAL
T840	DPRZ LT80	EAIRB ^{2 3 4 5 6 7}	PIR ^{5 6 9 10}	EM3B ^{11 12}	2LIN ¹³	LL ^{14 16}		
		BLT		EM3A ^{11 12}	3LIN ¹³			
		TW ³		EM3D ^{11 12}	2G			

- 1 For DALI LIN option wires are 2x0.5mm²
- 2 Ingress protection IP20
- 3 Please ask for special models with options EAIRB and TW
- 4 For option EAIRB luminaire housing is 65mm longer
- 5 The EAIRB, MW, PIR sensors are positioned in the end of the luminaire for lengths up to 1800mm, and in the middle of the luminaire for lengths over 1800mm
- 6 EAIRB, PIR options are not applicable for lengths under 800mm
- 7 For models G189...G191 and J664 EAIRB option cannot be combined with EM options
- 8 For option MW luminaire housing is 72mm longer
- 9 Ingress protection IP40
- 10 For option PIR luminaire housing is 50mm longer
- 11 EM options applicable for models longer than 1000mm
- 12 Operating temperature range for Luminaires with EM option, °C: ta 0... +35
- 13 LIN options applicable for models longer than 800mm, for shorter models 5 pole terminal block included as standard
- 14 For L and LL models joint kit and 1LIN option included (5TB option for lengths up to 800mm)
- 15 First/end luminaire, body is 14mm shorter than standalone version
- 16 In-line luminaire, body is 29mm shorter than standalone version
- 17 IP44 option not applicable for L and LL models

OP

DPRZ LT80

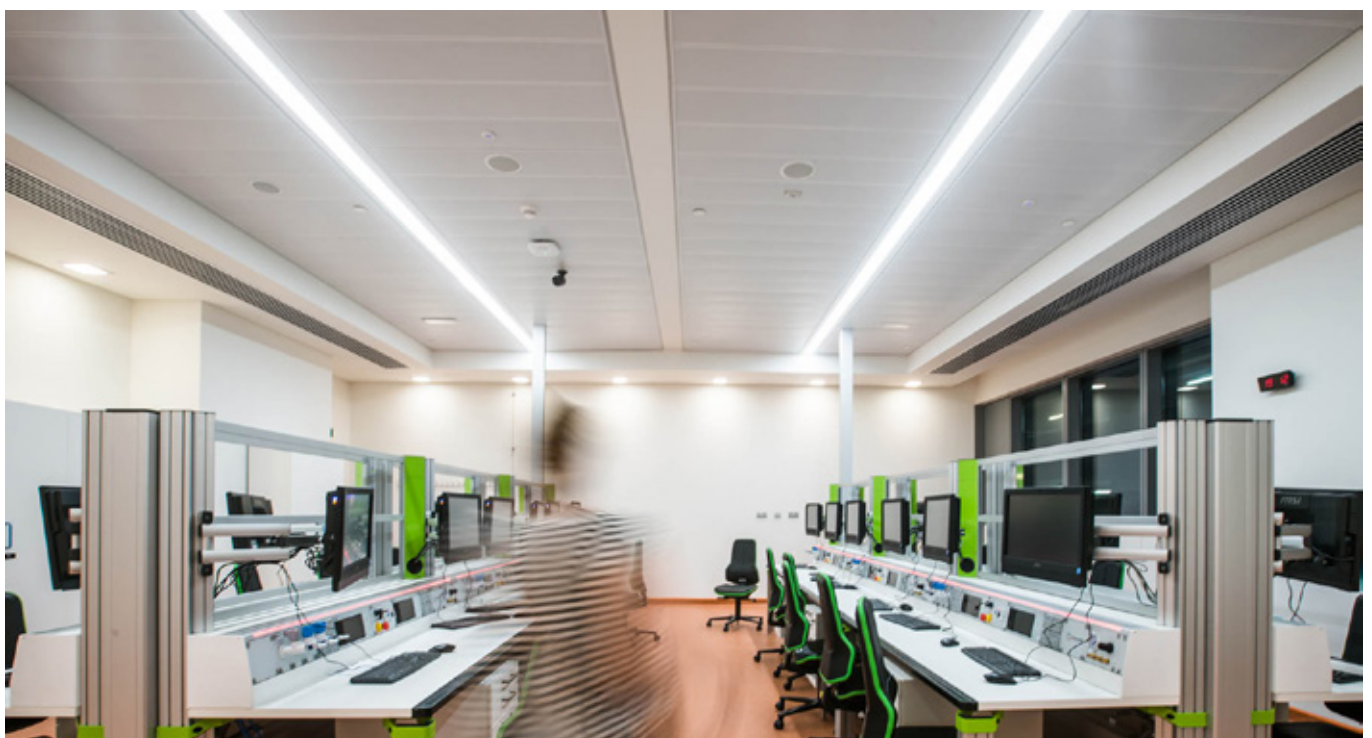
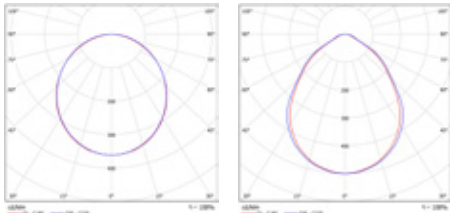



SERPENS LED CORNER90

Aluminum Profile Luminaires

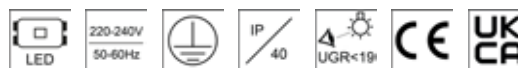

DESCRIPTION: **Recessed mounted middle profile LED luminaire for in-line connection**
Light distribution type: direct
Optical system: opal polycarbonate diffuser / matt micro-prismatic polycarbonate diffuser, low glare
Housing: aluminium
Colour: white, RAL9003S

GENERAL DATA: **Mains voltage:** 220-240V, 0/50-60Hz
LED lifetime, h: 50000/L80B10
SDCM: 3
Protection class IEC: I
Ingress protection code: IP40
Mechanical impact resistance: IK05
Glow wire test, °C: 650
Operating temperature range, °C: ta -15...+35

INSTALLATION: In ceilings with cut-out openings (mounting brackets included), with L/LL option is designed for in-line connection. Through wired, 3x1.5mm², push-in terminal 3x2x2.5mm² and supply cord

ENVIRONMENT: Indoor

APPLICATION: Office, education, hotel, corridor, retail, public place

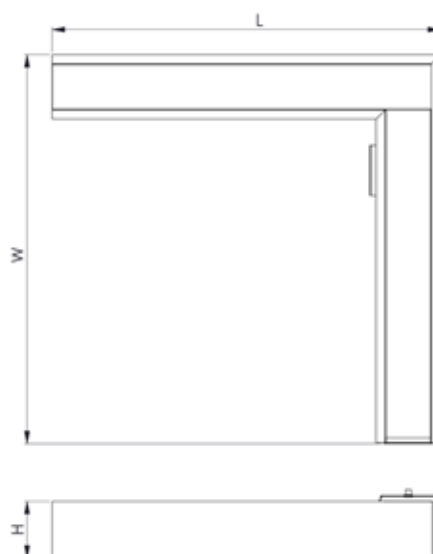

PRODUCT	LENGTH, mm	WIDTH, mm	HEIGHT, mm	CUT-OUT, mm	LUMINAIRE OUTPUT*, lm	SYSTEM POWER*, W	SYSTEM EFFICACY*, lm/W	CRI	CCT*, K	WEIGHT, kg
Serpens LED1x1250 G631 T840 OP LO1 1LIN LL CORNER90 SB	455	455	68	460x460x68	1206	10,1	119	80+	4000	1,9
Serpens LED1x1650 G632 T840 OP LO2 1LIN LL CORNER90 SB	455	455	68	460x460x68	1642	13,6	120	80+	4000	1,9
Serpens LED1x2300 G633 T840 OP LO3 1LIN LL CORNER90 SB	455	455	68	460x460x68	2258	18,9	120	80+	4000	1,9
Serpens LED1x1100 G631 T840 DPRZ LT80 LO1 1LIN LL CORNER90 SB	455	455	68	460x460x68	1053	10,1	104	80+	4000	1,9
Serpens LED1x1450 G632 T840 DPRZ LT80 LO2 1LIN LL CORNER90 SB	455	455	68	460x460x68	1435	13,6	105	80+	4000	1,9
Serpens LED1x2000 G633 T840 DPRZ LT80 LO3 1LIN LL CORNER90 SB	455	455	68	460x460x68	1972	18,9	104	80+	4000	1,9

*Tolerance range for optical and electrical data: ±10%. Values apply to an ambient temperature of 25°C. NORTHCLIFFE LIGHTING is constantly developing and improving its products. The right is reserved to change any product specifications without prior notification

OPTIONS AVAILABLE ON REQUEST:

LED	REFLECTOR AND OPTICS	CONTROL GEAR	CONNECTION	OTHER	COLOUR
T830	OP	DALI ¹	5TB	LL ³	RAL
T840	DPRZ LT80	BLT	1LIN		RAL9005S
		TW ²	2LIN		
			3LIN		
			2G		

- 1 For DALI LIN option wires are 2x0.5mm²
- 2 Ask for special models with option TW
- 3 For L and LL models joint kit and 1LIN option included

OP

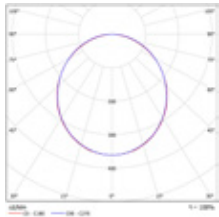

DPRZ LT80

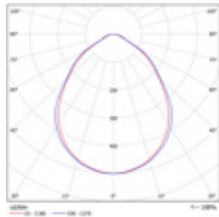

SERPENS P LED

Aluminum Profile Luminaires

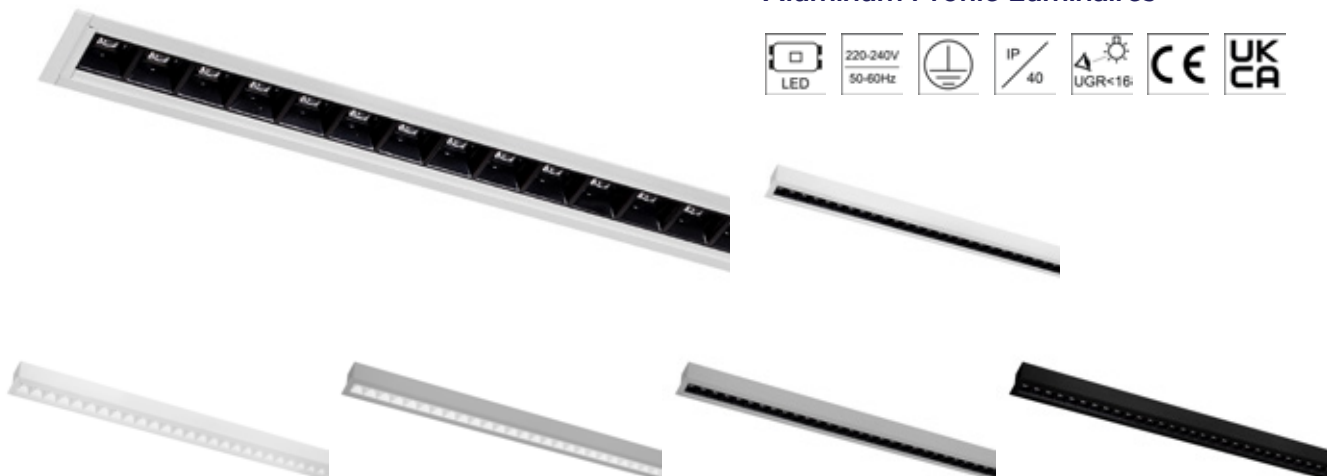
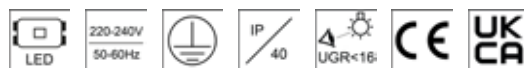

DESCRIPTION: Recessed mounted aluminium profile LED luminaire for in-line connection
Light distribution type: direct
Optical system: double parabolic reflector with lenses, low glare
Housing: aluminium
Colour: white, RAL9003S

GENERAL DATA: Mains voltage: 220-240V, 0/50-60Hz
LED lifetime, h: 100000/L80B10
SDCM: 3
Protection class IEC: I
Ingress protection code: IP40
Mechanical impact resistance: IK05
Operating temperature range, °C: ta 0...+35

INSTALLATION: In ceilings with cut-out openings (mounting brackets included). With L/LL option is designed for in-line connection. Push-in terminal, 3x2x2.5mm²

ENVIRONMENT: Indoor

APPLICATION: Office, education, hotel, corridor, retail, public place

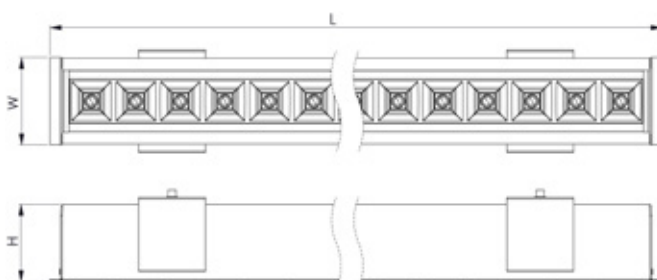

PRODUCT	LENGTH, mm	WIDTH, mm	HEIGHT, mm	CUT-OUT, mm	LUMINAIRE OUTPUT*, lm	SYSTEM POWER*, W	SYSTEM EFFICACY*, lm/W	CRI	CCT*, K	WEIGHT, kg
Serpens P LED1x2950 J257 T840 WGC LO1 SB	1150	77	68	1146x68	2920	17,6	166	80+	4000	2,5
Serpens P LED1x3600 J258 T840 WGC LO2 SB	1150	77	68	1146x68	3583	21,9	164	80+	4000	2,5
Serpens P LED1x4250 J259 T840 WGC LO3 SB	1150	77	68	1146x68	4223	26,1	162	80+	4000	2,5
Serpens P LED1x4900 J260 T840 WGC LO4 SB	1150	77	68	1146x68	4867	30,8	158	80+	4000	2,5
Serpens P LED1x3650 J261 T840 WGC LO1 SB	1435	77	68	1425x68	3650	21,7	168	80+	4000	2,9
Serpens P LED1x4500 J262 T840 WGC LO2 SB	1435	77	68	1425x68	4479	26,8	167	80+	4000	2,9
Serpens P LED1x5300 J263 T840 WGC LO3 SB	1435	77	68	1425x68	5278	32,0	165	80+	4000	2,9
Serpens P LED1x6150 J264 T840 WGC LO4 SB	1435	77	68	1425x68	6147	37,8	163	80+	4000	2,9
Serpens P LED1x5850 J265 T840 WGC LO1 SB	2272	77	68	2262x68	5840	33,3	175	80+	4000	4,3
Serpens P LED1x7200 J266 T840 WGC LO2 SB	2272	77	68	2262x68	7166	41,9	171	80+	4000	4,3
Serpens P LED1x8450 J267 T840 WGC LO3 SB	2272	77	68	2262x68	8446	50,6	167	80+	4000	4,3
Serpens P LED1x9750 J268 T840 WGC LO4 SB	2272	77	68	2262x68	9734	59,0	165	80+	4000	4,3
Serpens P LED1x7300 J269 T840 WGC LO1 SB	2829	77	68	2820x68	7300	41,6	175	80+	4000	5,8
Serpens P LED1x9000 J270 T840 WGC LO2 SB	2829	77	68	2820x68	8957	52,4	171	80+	4000	5,8
Serpens P LED1x10600 J271 T840 WGC LO3 SB	2829	77	68	2820x68	10557	62,6	169	80+	4000	5,8
Serpens P LED1x12300 J272 T840 WGC LO4 SB	2829	77	68	2820x68	12293	73,3	168	80+	4000	5,8

PRODUCT	LENGTH, mm	WIDTH, mm	HEIGHT, mm	CUT-OUT, mm	LUMINAIRE OUTPUT*, lm	SYSTEM POWER*, W	SYSTEM EFFICACY*, lm/W	CRI	CCT*, K	WEIGHT, kg
Serpens P LED1x2700 J257 T840 BGC LO1 SB	1150	77	68	1146x68	2695	17,6	153	80+	4000	2,5
Serpens P LED1x3350 J258 T840 BGC LO2 SB	1150	77	68	1146x68	3307	21,9	151	80+	4000	2,5
Serpens P LED1x3900 J259 T840 BGC LO3 SB	1150	77	68	1146x68	3898	26,1	149	80+	4000	2,5
Serpens P LED1x4500 J260 T840 BGC LO4 SB	1150	77	68	1146x68	4492	30,8	146	80+	4000	2,5
Serpens P LED1x3400 J261 T840 BGC LO1 SB	1435	77	68	1425x68	3369	21,7	155	80+	4000	2,9
Serpens P LED1x4150 J262 T840 BGC LO2 SB	1435	77	68	1425x68	4134	26,8	154	80+	4000	2,9
Serpens P LED1x4900 J263 T840 BGC LO3 SB	1435	77	68	1425x68	4872	32,0	152	80+	4000	2,9
Serpens P LED1x5700 J264 T840 BGC LO4 SB	1435	77	68	1425x68	5674	37,8	150	80+	4000	2,9
Serpens P LED1x5400 J265 T840 BGC LO1 SB	2272	77	68	2262x68	5391	33,3	162	80+	4000	4,3
Serpens P LED1x6650 J266 T840 BGC LO2 SB	2272	77	68	2262x68	6615	41,9	158	80+	4000	4,3
Serpens P LED1x7800 J267 T840 BGC LO3 SB	2272	77	68	2262x68	7796	50,6	154	80+	4000	4,3
Serpens P LED1x9000 J268 T840 BGC LO4 SB	2272	77	68	2262x68	8985	59,0	152	80+	4000	4,3
Serpens P LED1x6750 J269 T840 BGC LO1 SB	2829	77	68	2820x68	6738	41,6	162	80+	4000	5,8
Serpens P LED1x8300 J270 T840 BGC LO2 SB	2829	77	68	2820x68	8268	52,4	158	80+	4000	5,8
Serpens P LED1x9750 J271 T840 BGC LO3 SB	2829	77	68	2820x68	9745	62,6	156	80+	4000	5,8
Serpens P LED1x11350 J272 T840 BGC LO4 SB	2829	77	68	2820x68	11348	73,3	155	80+	4000	5,8

*Tolerance range for optical and electrical data: ±10%. Values apply to an ambient temperature of 25°C. NORTHCLIFFE LIGHTING is constantly developing and improving its products. The right is reserved to change any product specifications without prior notification

AVAILABLE ACCESSORIES:



Product: BLANK Serpens LED L1000mm LL RAL9003S
Description: Blank part kit for connecting luminaires in-line 1000mm long, 1pcs
**note - indicate length, location and RAL colour before placing order*
**note - BLANK through wiring option must meet luminaire options*

BLANK Serpens P LED with Capheus B LED (ask for special model)



OPTIONS AVAILABLE ON REQUEST:

LED	REFLECTOR AND OPTICS	CONTROL GEAR	SENSORS	EMERGENCY	CONNECTION	OTHER	COLOUR
T830	WGC	DALI ¹	MW ⁴ 7	EM3	1LIN	L ¹⁰	RAL
T840	BGC	EAIRB-M ² 3 4 5 6	PIR ⁴ 8 9	EM3B	2LIN	LL ¹¹	
	WMC	EAIRB-S ⁵ 6		EM3A	3LIN		
	BMC	BLT		EM3D	CBF3-2.0m clear		
	MGC	COR					
	MMC	COR1min					
	WAC/BAC	COR30min					

- 1 For DALI LIN option wires are 2x0.5mm²
- 2 Ingress protection IP20
- 3 For option EAIRB-M luminaire housing is 40mm longer
- 4 The EAIRB, MW, PIR sensors are positioned in the end of the luminaire for lengths up to 1800mm, and in the middle of the luminaire for lengths over 1800mm
- 5 Max system size 1x EAIRB-M + 3x EAIRB-S
- 6 Max wire length from EAIRB-M to last EAIRB-S - 11 m
- 7 For option MW luminaire housing is 72mm longer
- 8 Ingress protection IP40
- 9 For option PIR luminaire housing is 50mm longer
- 10 First/end luminaire, body is 16mm shorter than standalone version
- 11 In-line luminaire, body is 30mm shorter than standalone version

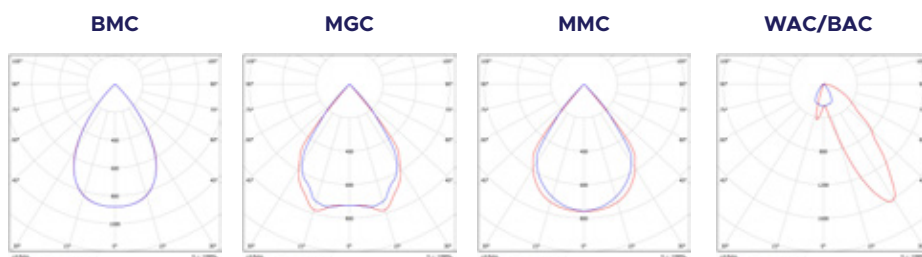
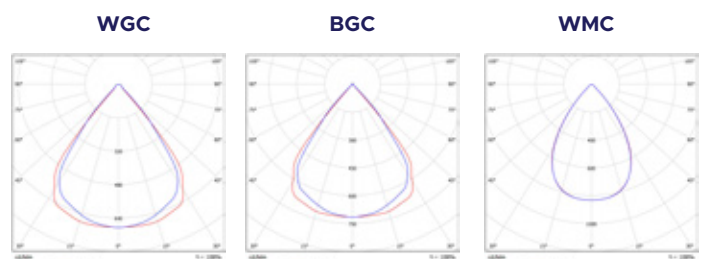

SERPENS O LED

Aluminum Profile Luminaires



DESCRIPTION: Recessed mounted aluminium profile LED luminaire for in-line connection
Light distribution type: direct
Optical system: lenses, low glare
Housing: aluminium
Colour: white, RAL9003S

GENERAL DATA: Mains voltage: 220-240V, 0/50-60Hz
LED lifetime, h: 100000/L80B10
SDCM: 3
Protection class IEC: I
Ingress protection code: IP40
Mechanical impact resistance: IK05
Operating temperature range, °C: ta 0...+35

INSTALLATION: In ceilings with cut-out openings (mounting brackets included). with L/LL option is designed for in-line connection. Push-in terminal, 3x2x2.5mm²

ENVIRONMENT: Indoor

APPLICATION: Office, education, hotel, corridor, retail, public place



PRODUCT	LENGTH, mm	WIDTH, mm	HEIGHT, mm	CUT-OUT, mm	LUMINAIRE OUTPUT*, lm	SYSTEM POWER*, W	SYSTEM EFFICACY*, lm/W	CRI	CCT*, K	WEIGHT, kg
Serpens O LED1x3800 J307 T840 L75 LO1 SB	1164	77	68	1158x68	3796	21,8	174	80+	4000	2,5
Serpens O LED1x5300 J308 T840 L75 LO2 SB	1164	77	68	1158x68	5260	31,7	166	80+	4000	2,5
Serpens O LED1x5550 J309 T840 L75 LO3 SB	1164	77	68	1158x68	5523	30,0	184	80+	4000	2,5
Serpens O LED1x6600 J310 T840 L75 LO4 SB	1164	77	68	1158x68	6567	35,9	183	80+	4000	2,5
Serpens O LED1x7600 J311 T840 L75 LO5 SB	1164	77	68	1158x68	7554	41,6	182	80+	4000	2,5
Serpens O LED1x4750 J312 T840 L75 LO1 SB	1444	77	68	1438x68	4746	27,0	176	80+	4000	2,9
Serpens O LED1x6600 J313 T840 L75 LO2 SB	1444	77	68	1438x68	6575	38,7	170	80+	4000	2,9
Serpens O LED1x6950 J314 T840 L75 LO3 SB	1444	77	68	1438x68	6904	36,7	188	80+	4000	2,9
Serpens O LED1x8250 J315 T840 L75 LO4 SB	1444	77	68	1438x68	8209	44,4	185	80+	4000	2,9
Serpens O LED1x9450 J316 T840 L75 LO5 SB	1444	77	68	1438x68	9442	51,5	183	80+	4000	2,9
Serpens O LED1x9500 J317 T840 L75 LO1 SB	2847	77	68	2841x68	9491	51,6	184	80+	4000	5,8
Serpens O LED1x13150 J318 T840 L75 LO2 SB	2847	77	68	2841x68	13150	75,0	175	80+	4000	5,8
Serpens O LED1x13850 J319 T840 L75 LO3 SB	2847	77	68	2841x68	13808	72,7	190	80+	4000	5,8
Serpens O LED1x16450 J320 T840 L75 LO4 SB	2847	77	68	2841x68	16418	87,0	189	80+	4000	5,8
Serpens O LED1x18900 J321 T840 L75 LO5 SB	2847	77	68	2841x68	18884	101,9	185	80+	4000	5,8

*Tolerance range for optical and electrical data: ±10%. Values apply to an ambient temperature of 25°C. NORTHCLIFFE LIGHTING is constantly developing and improving its products. The right is reserved to change any product specifications without prior notification

AVAILABLE ACCESSORIES:



Product: BLANK Serpens LED L1000mm LL RAL9003S
Description: Blank part kit for connecting luminaires in-line 1000mm long, 1pcs
**note - indicate length, location and RAL colour before placing order*
**note - BLANK through wiring option must meet luminaire options*

BLANK Serpens O LED with Capheus B LED
(ask for special model)



OPTIONS AVAILABLE ON REQUEST:

LED	REFLECTOR AND OPTICS	CONTROL GEAR	SENSORS	EMERGENCY	CONNECTION	OTHER	COLOUR
T830	L30	DALI ¹	MW ^{4 7}	EM3	1LIN	L ¹⁰	RAL
T840	L40x75	EAIRB-M ^{2 3 4 5 6}	PIR ^{4 8 9}	EM3B	2LIN	LL ¹¹	
	L75	EAIRB-S ^{5 6}		EM3A	3LIN		
	L75W	BLT		EM3D	CBF3-2.0m clear		
	L90W	COR					
	L100	COR1min					
	L1A18-L	COR30min					
	L1A18-R						
	L2A25						

- 1 For DALI LIN option wires are 2x0.5mm²
- 2 Ingress protection IP20
- 3 For option EAIRB-M luminaire housing is 40mm longer
- 4 The EAIRB, MW, PIR sensors are positioned in the end of the luminaire for lengths up to 1800mm, and in the middle of the luminaire for lengths over 1800mm
- 5 Max system size 1x EAIRB-M + 3x EAIRB-S
- 6 Max wire length from EAIRB-M to last EAIRB-S - 11 m
- 7 For option MW luminaire housing is 72mm longer
- 8 Ingress protection IP40
- 9 For option PIR luminaire housing is 50mm longer
- 10 First/end luminaire, body is 16mm shorter than standalone version
- 11 In-line luminaire, body is 32mm shorter than standalone version

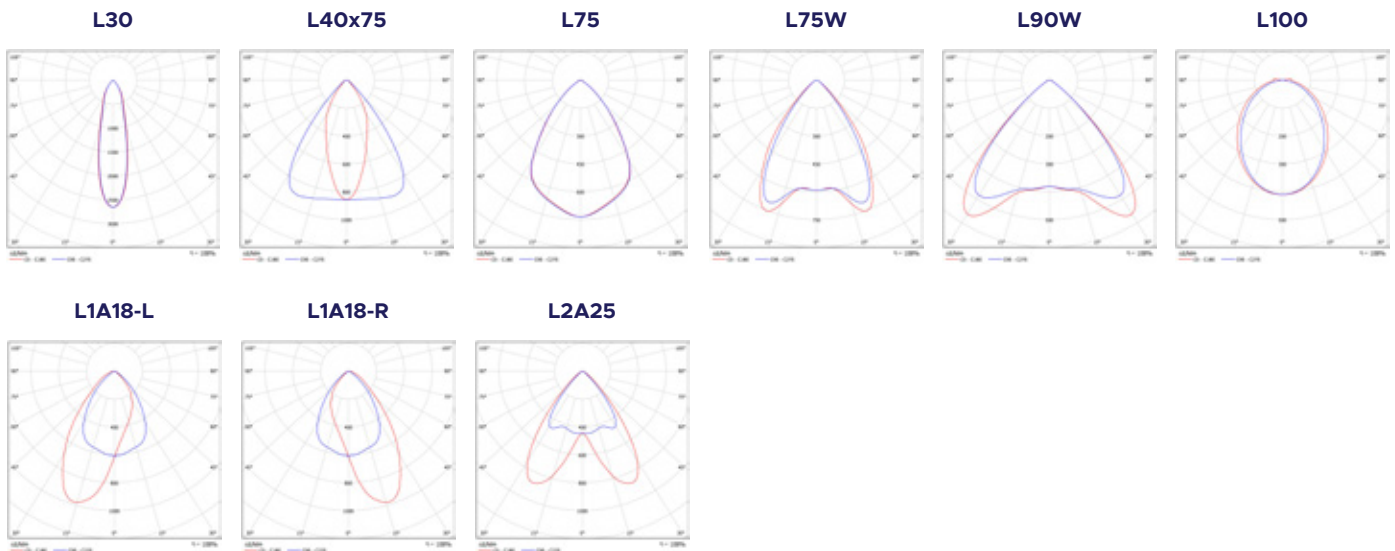

DECOR S LED

Aluminum Profile Luminaires



DESCRIPTION: Surface mounted or suspended slim profile LED luminaire for in-line connection
Light distribution type: direct
Optical system: opal polycarbonate diffuser
Housing: aluminium
Colour: light grey, RAL9006S; white, RAL9003S; black, RAL9005S

GENERAL DATA: **Mains voltage:** 220-240V, 0/50-60Hz
LED lifetime, h: 50000/L80B10
SDCM: 3
Protection class IEC: I
Ingress protection code: IP40
Mechanical impact resistance: IK05
Glow wire test, °C: 650
Operating temperature range, °C: ta 0...+35

INSTALLATION: On the ceiling or suspended (wire, cable and cap to be ordered separately) with L/LL options is designed for in-line connection. Push-in terminal, 3x2x2.5mm²

ENVIRONMENT: Indoor

APPLICATION: Office, education, hotel, corridor, retail, public place

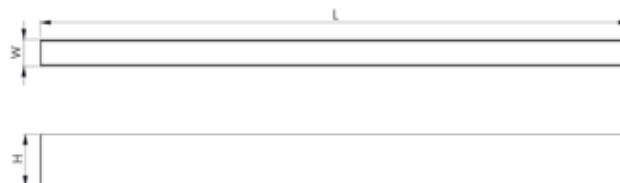

PRODUCT	LENGTH, mm	WIDTH, mm	HEIGHT, mm	LUMINAIRE OUTPUT*, lm	SYSTEM POWER*, W	SYSTEM EFFICACY*, lm/W	CRI	CCT*, K	WEIGHT, kg
Decor S LED1x650 G384 T840 OP LO1	578	40	75	610	6,8	90	80+	4000	1,3
Decor S LED1x850 G385 T840 OP LO2	578	40	75	832	9,6	86	80+	4000	1,3
Decor S LED1x1150 G386 T840 OP LO3	578	40	75	1143	13,3	86	80+	4000	1,3
Decor S LED1x1750 J853 T840 OP LO4	578	40	75	1715	18,9	91	80+	4000	1,3
Decor S LED1x950 G387 T840 OP LO1	858	40	75	916	10,1	90	80+	4000	1,8
Decor S LED1x1250 G388 T840 OP LO2	858	40	75	1247	13,6	91	80+	4000	1,8
Decor S LED1x1750 G389 T840 OP LO3	858	40	75	1715	18,9	91	80+	4000	1,8
Decor S LED1x2600 J854 T840 OP LO4	858	40	75	2572	28,7	90	80+	4000	1,8
Decor S LED1x1250 G390 T840 OP LO1	1138	40	75	1220	12,7	96	80+	4000	2,4
Decor S LED1x1700 G391 T840 OP LO2	1138	40	75	1663	17,1	97	80+	4000	2,4
Decor S LED1x2300 G392 T840 OP LO3	1138	40	75	2286	24,7	93	80+	4000	2,4
Decor S LED1x3450 J855 T840 OP LO4	1138	40	75	3430	38,6	89	80+	4000	2,4
Decor S LED1x1550 G393 T840 OP LO1	1418	40	75	1526	15,9	96	80+	4000	2,9
Decor S LED1x2100 G394 T840 OP LO2	1418	40	75	2079	21,4	97	80+	4000	2,9
Decor S LED1x2900 G395 T840 OP LO3	1418	40	75	2858	30,8	93	80+	4000	2,9
Decor S LED1x4300 J856 T840 OP LO4	1418	40	75	4287	47,8	90	80+	4000	2,9
Decor S LED1x1850 G396 T840 OP LO1	1698	40	75	1831	18,0	102	80+	4000	3,4
Decor S LED1x2500 G397 T840 OP LO2	1698	40	75	2495	25,2	99	80+	4000	3,4
Decor S LED1x3450 G398 T840 OP LO3	1698	40	75	3430	37,0	93	80+	4000	3,4
Decor S LED1x5150 J857 T840 OP LO4	1698	40	75	5144	56,7	91	80+	4000	3,4

PRODUCT	LENGTH, mm	WIDTH, mm	HEIGHT, mm	LUMINAIRE OUTPUT*, lm	SYSTEM POWER*, W	SYSTEM EFFICACY*, lm/W	CRI	CCT*, K	WEIGHT, kg
Decor S LED1x2150 G399 T840 OP LO1	1978	40	75	2136	21,0	102	80+	4000	4,0
Decor S LED1x2950 G400 T840 OP LO2	1978	40	75	2911	29,3	99	80+	4000	4,0
Decor S LED1x4050 G401 T840 OP LO3	1978	40	75	4001	43,2	93	80+	4000	4,0
Decor S LED1x6450 J858 T840 OP LO4	1978	40	75	6430	70,1	92	80+	4000	4,0
Decor S LED1x2450 G590 T840 OP LO1	2258	40	75	2441	23,5	104	80+	4000	4,6
Decor S LED1x3350 G591 T840 OP LO2	2258	40	75	3326	33,6	99	80+	4000	4,6
Decor S LED1x4600 G592 T840 OP LO3	2258	40	75	4573	48,7	94	80+	4000	4,6
Decor S LED1x6900 J859 T840 OP LO4	2258	40	75	6859	77,3	89	80+	4000	4,6
Decor S LED1x2750 G593 T840 OP LO1	2538	40	75	2746	26,4	104	80+	4000	5,1
Decor S LED1x3750 G594 T840 OP LO2	2538	40	75	3742	37,7	99	80+	4000	5,1
Decor S LED1x5150 G595 T840 OP LO3	2538	40	75	5144	54,8	94	80+	4000	5,1
Decor S LED1x7750 J860 T840 OP LO4	2538	40	75	7716	83,2	93	80+	4000	5,1
Decor S LED1x3250 G596 T840 OP LO1	2958	40	75	3204	30,9	104	80+	4000	6,0
Decor S LED1x4400 G597 T840 OP LO2	2958	40	75	4366	44,0	99	80+	4000	6,0
Decor S LED1x6050 G598 T840 OP LO3	2958	40	75	6001	64,0	94	80+	4000	6,0

*Tolerance range for optical and electrical data: ±10%. Values apply to an ambient temperature of 25°C. NORTHCLIFFE LIGHTING is constantly developing and improving its products. The right is reserved to change any product specifications without prior notification

AVAILABLE ACCESSORIES:



Product: Suspension MTG KIT SUSI
Description: Suspension wire set "I" type, 1.5m adjustable, 1pcs
**note - 2pcs MTG SUSI KIT for length up to 2000mm*
**note - SUS option is required*



Product: CAP cable 3x0.75 2.0m clear
Description: Cable 3x0.75mm² for suspended luminaire up to 2.0 meters, transparent



Product: WALL MTG KIT - Decor S LED RAL9006S
Description: Support bracket for Decor S LED luminaire installation onto the wall, 1pcs
**note - 2pcs WALL MTG KIT for length up to 2000mm*



Product: CAP4, light grey/ white/ black
Description: Square decorative metal cap for hiding cable inlet with suspension wire attachment point, push-in terminals 3x1x1.5mm², light grey/ white/ black



Product: CAP cable clip D6.3mm SET clear
Description: Cable and suspension wire clip set, 4pcs. For cable diameter up to 6,3mm and wire diameter 1mm



Product: CAP5, light grey/ white/ black
Description: Square decorative metal cap for hiding cable inlet with suspension wire attachment point, push-in terminals 5x1x1.5mm², light grey/ white/ black



Product: Panel removal tool
Description: A pair of Serpens S / Decor S panel removal tools for neat panel removal during installation

OPTIONS AVAILABLE ON REQUEST:

LED	REFLECTOR AND OPTICS	CONTROL GEAR	EMERGENCY	CONNECTION	OTHER	COLOUR
T830	OP	DALI ¹	EM3 ³	1LIN ⁴	L ⁵ 6	RAL
T840		PULL ²	EM3B ³	2LIN ⁴	LL ⁵ 7	
		PULLDIM ²	EM3A ³	3LIN ⁴	SUS ⁸	
		BLT	EM3D ³	2G		
				CBF3-2.0m clear		
				CBF3-3.0m clear		
				CBF5-2.0m clear		
				CBF5-3.0m clear		

- 1 For DALI LIN option wires are 2x0.5mm²
- 2 For PULL and PULLDIM option luminaire housing is 40mm longer and switch is positioned at the end of luminaire
- 3 EM options applicable for models longer than 1000mm
- 4 LIN options applicable for models longer than 800mm
- 5 For L and LL models 3LIN option applicable for models longer than 800mm
- 6 First/end luminaire, body is 9mm shorter than standalone version
- 7 In-line luminaire, body is 15mm shorter than standalone version
- 8 For suspended luminaires it is recommended to use one of CBF option for easier mounting

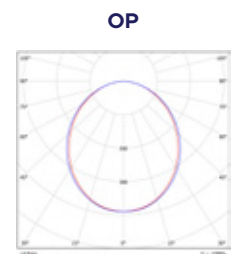

DECOR LED

Aluminum Profile Luminaires



DESCRIPTION: **Surface mounted or suspended middle profile LED luminaire for in-line connection**
Light distribution type: direct
Optical system: opal polycarbonate diffuser / matt micro-prismatic polycarbonate diffuser, low glare
Housing: aluminium
Colour: light grey, RAL9006S; white, RAL9003S; black, RAL9005S

GENERAL DATA: **Mains voltage:** 220-240V, 0/50-60Hz
LED lifetime, h: 50000/L80B10
SDCM: 3
Protection class IEC: I
Ingress protection code: IP40 (IP44 optional)
Mechanical impact resistance: IK05
Glow wire test, °C: 650
Operating temperature range, °C: ta -15...+35

INSTALLATION: On the ceiling or suspended (wire, cable and cap to be ordered separately), with L/LL option is designed for in-line connection. Push-in terminal, 3x2x2.5mm²

ENVIRONMENT: Indoor

APPLICATION: Office, education, hotel, corridor, retail, public place



PRODUCT	LENGTH, mm	WIDTH, mm	HEIGHT, mm	LUMINAIRE OUTPUT*, lm	SYSTEM POWER*, W	SYSTEM EFFICACY*, lm/W	CRI	CCT*, K	WEIGHT, kg
Decor LED1x850 G210 T840 OP LO1	573	58	68	803	6,8	119	80+	4000	1,3
Decor LED1x1100 G211 T840 OP LO2	573	58	68	1095	9,6	114	80+	4000	1,3
Decor LED1x1550 G212 T840 OP LO3	573	58	68	1505	13,3	113	80+	4000	1,3
Decor LED1x2300 J654 T840 OP LO4	573	58	68	2258	18,9	119	80+	4000	1,3
Decor LED1x1250 G213 T840 OP LO1	853	58	68	1206	10,1	119	80+	4000	1,8
Decor LED1x1650 G214 T840 OP LO2	853	58	68	1642	13,6	120	80+	4000	1,8
Decor LED1x2300 G215 T840 OP LO3	853	58	68	2258	18,9	120	80+	4000	1,8
Decor LED1x3400 J655 T840 OP LO4	853	58	68	3387	28,7	118	80+	4000	1,8
Decor LED1x1650 G216 T840 OP LO1	1133	58	68	1607	12,7	126	80+	4000	2,3
Decor LED1x2200 G217 T840 OP LO2	1133	58	68	2190	17,1	128	80+	4000	2,3
Decor LED1x3050 G218 T840 OP LO3	1133	58	68	3010	24,7	122	80+	4000	2,3
Decor LED1x4550 J656 T840 OP LO4	1133	58	68	4516	38,6	117	80+	4000	2,3
Decor LED1x2050 G219 T840 OP LO1	1413	58	68	2009	15,9	126	80+	4000	2,6
Decor LED1x2750 G220 T840 OP LO2	1413	58	68	2737	21,4	128	80+	4000	2,6
Decor LED1x3800 G221 T840 OP LO3	1413	58	68	3763	30,8	122	80+	4000	2,6
Decor LED1x5650 J657 T840 OP LO4	1413	58	68	5645	47,8	118	80+	4000	2,6
Decor LED1x2450 G222 T840 OP LO1	1693	58	68	2410	18,0	134	80+	4000	3,1
Decor LED1x3300 G223 T840 OP LO2	1693	58	68	3285	25,2	130	80+	4000	3,1
Decor LED1x4550 G224 T840 OP LO3	1693	58	68	4516	37,0	122	80+	4000	3,1

PRODUCT	LENGTH, mm	WIDTH, mm	HEIGHT, mm	LUMINAIRE OUTPUT*, lm	SYSTEM POWER*, W	SYSTEM EFFICACY*, lm/W	CRI	CCT*, K	WEIGHT, kg
Decor LED1x6800 J658 T840 OP LO4	1693	58	68	6773	56,7	119	80+	4000	3,1
Decor LED1x2850 G225 T840 OP LO1	1973	58	68	2812	21,0	134	80+	4000	3,4
Decor LED1x3850 G226 T840 OP LO2	1973	58	68	3832	29,3	131	80+	4000	3,4
Decor LED1x5300 G227 T840 OP LO3	1973	58	68	5268	43,2	122	80+	4000	3,4
Decor LED1x8500 J659 T840 OP LO4	2113	58	68	8466	70,1	121	80+	4000	3,7
Decor LED1x3250 G228 T840 OP LO1	2253	58	68	3214	23,5	137	80+	4000	4,0
Decor LED1x4400 G229 T840 OP LO2	2253	58	68	4380	33,6	130	80+	4000	4,0
Decor LED1x6050 G230 T840 OP LO3	2253	58	68	6021	48,7	124	80+	4000	4,0
Decor LED1x9050 J660 T840 OP LO4	2253	58	68	9030	77,3	117	80+	4000	4,0
Decor LED1x3650 G231 T840 OP LO1	2533	58	68	3616	26,4	137	80+	4000	4,6
Decor LED1x4950 G232 T840 OP LO2	2533	58	68	4927	37,7	131	80+	4000	4,6
Decor LED1x6800 G233 T840 OP LO3	2533	58	68	6773	54,8	124	80+	4000	4,6
Decor LED1x10200 J661 T840 OP LO4	2533	58	68	10159	83,2	122	80+	4000	4,6
Decor LED1x4250 G234 T840 OP LO1	2953	58	68	4219	30,9	137	80+	4000	5,0
Decor LED1x5750 G235 T840 OP LO2	2953	58	68	5748	44,0	131	80+	4000	5,0
Decor LED1x7950 G236 T840 OP LO3	2953	58	68	7902	64,0	124	80+	4000	5,0
Decor LED1x750 G210 T840 DPRZ LT80 LO1	573	58	68	702	6,8	104	80+	4000	1,3
Decor LED1x1000 G211 T840 DPRZ LT80 LO2	573	58	68	956	9,6	99	80+	4000	1,3
Decor LED1x1350 G212 T840 DPRZ LT80 LO3	573	58	68	1314	13,3	99	80+	4000	1,3
Decor LED1x2000 J654 T840 DPRZ LT80 LO4	573	58	68	1972	18,9	104	80+	4000	1,3
Decor LED1x1100 G213 T840 DPRZ LT80 LO1	853	58	68	1053	10,1	104	80+	4000	1,8
Decor LED1x1450 G214 T840 DPRZ LT80 LO2	853	58	68	1435	13,6	105	80+	4000	1,8
Decor LED1x2000 G215 T840 DPRZ LT80 LO3	853	58	68	1972	18,9	104	80+	4000	1,8
Decor LED1x3000 J655 T840 DPRZ LT80 LO4	853	58	68	2958	28,7	103	80+	4000	1,8
Decor LED1x1450 G216 T840 DPRZ LT80 LO1	1133	58	68	1403	12,7	110	80+	4000	2,3
Decor LED1x1950 G217 T840 DPRZ LT80 LO2	1133	58	68	1913	17,1	112	80+	4000	2,3
Decor LED1x2650 G218 T840 DPRZ LT80 LO3	1133	58	68	2629	24,7	107	80+	4000	2,3
Decor LED1x3950 J656 T840 DPRZ LT80 LO4	1133	58	68	3944	38,6	102	80+	4000	2,3
Decor LED1x1800 G219 T840 DPRZ LT80 LO1	1413	58	68	1755	15,9	110	80+	4000	2,6
Decor LED1x2400 G220 T840 DPRZ LT80 LO2	1413	58	68	2391	21,4	111	80+	4000	2,6
Decor LED1x3300 G221 T840 DPRZ LT80 LO3	1413	58	68	3286	30,8	107	80+	4000	2,6
Decor LED1x4950 J657 T840 DPRZ LT80 LO4	1413	58	68	4930	47,8	103	80+	4000	2,6
Decor LED1x2150 G222 T840 DPRZ LT80 LO1	1693	58	68	2105	18,0	117	80+	4000	3,1
Decor LED1x2900 G223 T840 DPRZ LT80 LO2	1693	58	68	2869	25,2	114	80+	4000	3,1
Decor LED1x3950 G224 T840 DPRZ LT80 LO3	1693	58	68	3944	37,0	107	80+	4000	3,1
Decor LED1x5950 J658 T840 DPRZ LT80 LO4	1693	58	68	5915	56,7	104	80+	4000	3,1
Decor LED1x2500 G225 T840 DPRZ LT80 LO1	1973	58	68	2456	21,0	117	80+	4000	3,4
Decor LED1x3350 G226 T840 DPRZ LT80 LO2	1973	58	68	3347	29,3	114	80+	4000	3,4
Decor LED1x4650 G227 T840 DPRZ LT80 LO3	1973	58	68	4601	43,2	107	80+	4000	3,4
Decor LED1x7400 J659 T840 DPRZ LT80 LO4	2113	58	68	7395	70,1	105	80+	4000	3,7
Decor LED1x2850 G228 T840 DPRZ LT80 LO1	2253	58	68	2807	23,5	120	80+	4000	4,0
Decor LED1x3850 G229 T840 DPRZ LT80 LO2	2253	58	68	3825	33,6	114	80+	4000	4,0
Decor LED1x5300 G230 T840 DPRZ LT80 LO3	2253	58	68	5258	48,7	108	80+	4000	4,0
Decor LED1x7900 J660 T840 DPRZ LT80 LO4	2253	58	68	7887	77,3	102	80+	4000	4,0
Decor LED1x3200 G231 T840 DPRZ LT80 LO1	2533	58	68	3158	26,4	120	80+	4000	4,6
Decor LED1x4350 G232 T840 DPRZ LT80 LO2	2533	58	68	4304	37,7	114	80+	4000	4,6
Decor LED1x5950 G233 T840 DPRZ LT80 LO3	2533	58	68	5915	54,8	108	80+	4000	4,6
Decor LED1x8900 J661 T840 DPRZ LT80 LO4	2533	58	68	8873	83,2	107	80+	4000	4,6
Decor LED1x3700 G234 T840 DPRZ LT80 LO1	2953	58	68	3685	30,9	119	80+	4000	5,0
Decor LED1x5050 G235 T840 DPRZ LT80 LO2	2953	58	68	5020	44,0	114	80+	4000	5,0
Decor LED1x6950 G236 T840 DPRZ LT80 LO3	2953	58	68	6901	64,0	108	80+	4000	5,0

*Tolerance range for optical and electrical data: ±10%. Values apply to an ambient temperature of 25°C. NORTHCLIFFE LIGHTING is constantly developing and improving its products. The right is reserved to change any product specifications without prior notification

AVAILABLE ACCESSORIES:



Product: Suspension MTG KIT SUSI
Description: Suspension wire set "I" type, 1.5m adjustable, 1pcs
**note - 2pcs MTG SUSI KIT for length up to 2000mm, 3pcs MTG SUSI KIT for lengths 2000 - 3000mm*
**note - SUS option is required*



Product: CAP cable 3x0.75 2.0m clear
Description: Cable 3x0.75mm² for suspended luminaire up to 2.0 meters, transparent



Product: WALL MTG KIT - Decor LED RAL9006S
Description: Support bracket for luminaire installation onto the wall. Decor LED, 1pcs
**note - 2pcs WALL MTG KIT for length up to 2000mm, 3pcs WALL MTG KIT for length 2000 - 3000mm*



Product: I-JOIN MTG KIT Decor LED RAL9006S
Description: "I" type joint kit for connecting luminaires in-line
**note - check RAL colour to match luminaire*



Product: L-JOIN MTG KIT Decor LED RAL9006S
Description: "L" type joint kit for connecting luminaires in-line
**note - check RAL colour to match luminaire*



Product: T-JOIN MTG KIT Decor LED RAL9006S
Description: "T" type joint kit for connecting luminaires in-line
**note - check RAL colour to match luminaire*



Product: X-JOIN MTG KIT Decor LED RAL9006S
Description: "X" type joint kit for connecting luminaires in-line
**note - check RAL colour to match luminaire*



Product: BLANK Decor LED L1000mm RAL9006S
Description: Blank DECOR LED kit for connecting luminaires in-line 1000mm long, 1pcs
**note - BLANK through wiring option must meet luminaire options*
**note - indicate needed length, location and RAL colour placing order*



Product: CAP4, light grey/ white/ black
Description: Square decorative metal cap for hiding cable inlet with suspension wire attachment point, push-in terminals 3x1x1.5mm², light grey/ white/ black



Product: CAP5, light grey/ white/ black
Description: Square decorative metal cap for hiding cable inlet with suspension wire attachment point, push-in terminals 5x1x1.5mm², light grey/ white/ black

Product: CAP cable clip D6.3mm SET clear
Description: Cable and suspension wire clip set, 4pcs. For cable diameter up to 6,3mm and wire diameter 1mm

OPTIONS AVAILABLE ON REQUEST:

LED	REFLECTOR AND OPTICS	CONTROL GEAR	SENSORS	EMERGENCY	CONNECTION	OTHER	PROTECTION	COLOUR
T830	OP	DALI ¹	MW ^{6,7}	EM3 ^{11,12}	1LIN ¹³	L ^{14,15}	IP44 ²⁰	RAL
T840	DPRZ LT80	EAIRB ^{2,3,4,5,6,7}	PIR ^{3,7,9,10}	EM3B ^{11,12}	2LIN ¹³	LL ^{14,16}		
		TW ⁵		EM3A ^{11,12}	3LIN ¹³	I-join L ^{17,18}		
		PULL ⁸		EM3D ^{11,12}	2G	I-join LL ^{17,18}		
		PULLDIM ⁹			CBF3-2.0m clear	L I-join LL ^{17,18}		
		BLT			CBF3-3.0m clear	SUS ¹⁹		
					CBF5-2.0m clear			
					CBF5-3.0m clear			

- 1 For DALI LIN option wires are 2x0.5mm²
- 2 Ingress protection IP20
- 3 The EAIRB and PIR options are not applicable for lengths under 800mm
- 4 For models G216..G218 and J656 EAIRB option cannot be combined with EM options
- 5 Please ask for special models with options EAIRB and TW
- 6 For MW option luminaire housing is 72mm longer, and visible part of the sensor is white. MW option is not applicable for 573mm long versions
- 7 The EAIRB, MW and PIR sensors is positioned in the end of the luminaire for lengths up to 1800mm, and in the middle of the luminaire for lengths over 1800mm
- 8 For PULL and PULLDIM options luminaire housing is 50mm longer and switch is positioned at the end of luminaire
- 9 Ingress protection IP40
- 10 For option PIR luminaire housing is 50mm longer
- 11 EM options applicable for models longer than 1000mm
- 12 Operating temperature range for Luminaires with EM option, °C: ta 0... +35
- 13 LIN options applicable for models longer than 800mm, for shorter models 5 pole terminal block included as standard
- 14 For L and LL models joint kit and 1LIN option included (5TB option for lengths up to 800mm)
- 15 First/end luminaire, body is 5mm shorter than standalone version
- 16 In-line luminaire, body is 10mm shorter than standalone version
- 17 For I-join L and I-join LL models joint kit not included, 1LIN option included (5TB option for lengths up to 800mm)
- 18 The luminaire must have I-join L, I-join LL or L I-join LL options, depending on installation position
- 19 For suspended luminaires it is recommended to use one of CBF option for easier mounting
- 20 IP44 option not applicable for L and LL models

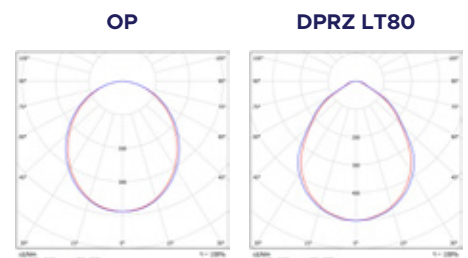



DECOR LED CORNER90

Aluminum Profile Luminaires

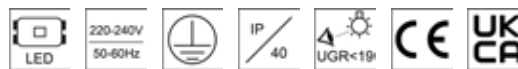

DESCRIPTION: **Surface mounted or suspended LED luminaire**
Light distribution type: direct
Optical system: opal polycarbonate diffuser / matt micro-prismatic polycarbonate diffuser, low glare
Housing: aluminium
Colour: light grey, RAL9006S; white, RAL9003S; black, RAL9005S

GENERAL DATA: **Mains voltage:** 220-240V, 0/50-60Hz
LED lifetime, h: 50000/L80B10
SDCM: 3
Protection class IEC: I
Ingress protection code: IP40
Mechanical impact resistance: IK05
Glow wire test, °C: 650
Operating temperature range, °C: ta -15...+35

INSTALLATION: On the ceiling or suspended (wire, cable and cap to be ordered separately), with L/LL option is designed for in-line connection. Through wired, 3x1.5mm², push-in terminal 3x2x2.5mm² and supply cord

ENVIRONMENT: Indoor

APPLICATION: Office, education, hotel, corridor, retail, public place

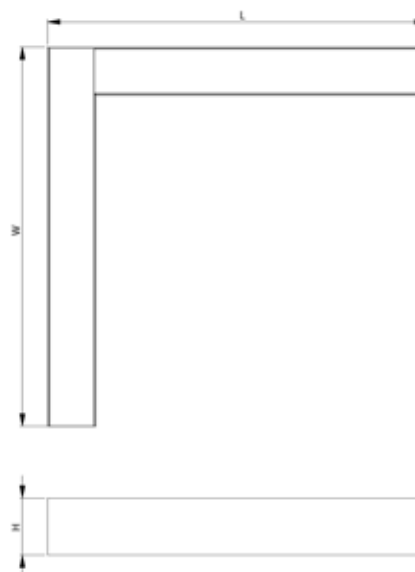

PRODUCT	LENGTH, mm	WIDTH, mm	HEIGHT, mm	LUMINAIRE OUTPUT*, lm	SYSTEM POWER*, W	SYSTEM EFFICACY*, lm/W	CRI	CCT*, K	WEIGHT, kg
Decor LED1x1250 G628 T840 OP LO1 1LIN LL CORNER90	455	455	68	1206	10,1	119	80+	4000	1,9
Decor LED1x1650 G629 T840 OP LO2 1LIN LL CORNER90	455	455	68	1642	13,6	120	80+	4000	1,9
Decor LED1x2300 G630 T840 OP LO3 1LIN LL CORNER90	455	455	68	2258	18,9	120	80+	4000	1,9
Decor LED1x1100 G628 T840 DPRZ LT80 LO1 1LIN LL CORNER90	455	455	68	1053	10,1	104	80+	4000	1,9
Decor LED1x1450 G629 T840 DPRZ LT80 LO2 1LIN LL CORNER90	455	455	68	1435	13,6	105	80+	4000	1,9
Decor LED1x2000 G630 T840 DPRZ LT80 LO3 1LIN LL CORNER90	455	455	68	1972	18,9	104	80+	4000	1,9

*Tolerance range for optical and electrical data: ±10%. Values apply to an ambient temperature of 25°C. NORTHCLIFFE LIGHTING is constantly developing and improving its products. The right is reserved to change any product specifications without prior notification

AVAILABLE ACCESSORIES:



Product: Suspension MTG KIT SUSI
Description: Suspension wire set "I" type, 1.5m adjustable, 1pcs
**note - 1pcs MTG SUSI KIT for corner luminaire*
**note - SUS option is required*



Product: CAP cable clip D6.3mm SET clear
Description: Cable and suspension wire clip set, 4pcs. For cable diameter up to 6,3mm and wire diameter 1mm



Product: CAP cable 3x0.75 2.0m clear
Description: Cable 3x0.75mm² for suspended luminaire up to 2.0 meters, transparent



Product: CAP4, light grey/ white/ black
Description: Square decorative metal cap for hiding cable inlet with suspension wire attachment point, push-in terminals 3x1x1.5mm², light grey/ white/ black

Product: CAP5, light grey/ white/ black
Description: Square decorative metal cap for hiding cable inlet with suspension wire attachment point, push-in terminals 5x1x1.5mm², light grey/ white/ black

OPTIONS AVAILABLE ON REQUEST:

LED	REFLECTOR AND OPTICS	CONTROL GEAR	CONNECTION	OTHER	COLOUR
T830	OP	DALI ¹	1LIN	LL ³	RAL
T840	DPRZ LT80	BLT	2LIN	SUS ⁴	
		TW ²	3LIN		
			2G		
			CBF3-2.0m clear		
			CBF3-3.0m clear		
			CBF5-2.0m clear		
			CBF5-3.0m clear		

- 1 For DALI LIN option wires are 2x0.5mm²
- 2 Ask for special models with option TW
- 3 For L and LL models joint kit and 1LIN option included
- 4 For suspended luminaires it is recommended to use one of CBF option for easier mounting

OP

DPRZ LT80

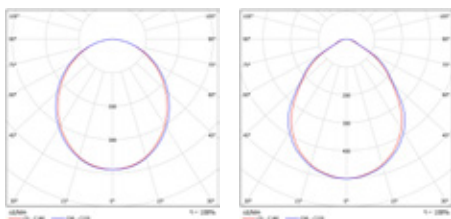

DECOR P LED

Aluminum Profile Luminaires



DESCRIPTION: Surface mounted or suspended slim profile LED luminaire for in-line connection
Light distribution type: direct
Optical system: double parabolic reflector with lenses, low glare
Housing: aluminium
Colour: light grey, RAL9006S; white, RAL9003S; black, RAL9005S

GENERAL DATA: Mains voltage: 220-240V, 0/50-60Hz
 LED lifetime, h: 100000/L80B10
 SDCM: 3
 Protection class IEC: I
 Ingress protection code: IP40
 Mechanical impact resistance: IK05
 Operating temperature range, °C: ta 0..+35

INSTALLATION: On the ceiling or suspended (wire, cable and cap to be ordered separately), with L/LL option is designed for in-line connection. Push-in terminal, 3x2x2.5mm²

ENVIRONMENT: Indoor

APPLICATION: Office, education, hotel, corridor, retail, public place

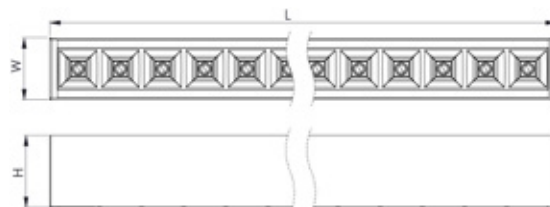

PRODUCT	LENGTH, mm	WIDTH, mm	HEIGHT, mm	LUMINAIRE OUTPUT*, lm	SYSTEM POWER*, W	SYSTEM EFFICACY*, lm/W	CRI	CCT*, K	WEIGHT, kg
Decor P LED1x2950 J273 T840 WGC LO1	1134	58	68	2920	17,6	166	80+	4000	2,3
Decor P LED1x3600 J274 T840 WGC LO2	1134	58	68	3583	21,9	164	80+	4000	2,3
Decor P LED1x4250 J275 T840 WGC LO3	1134	58	68	4223	26,1	162	80+	4000	2,3
Decor P LED1x4900 J276 T840 WGC LO4	1134	58	68	4867	30,8	158	80+	4000	2,3
Decor P LED1x3650 J277 T840 WGC LO1	1413	58	68	3650	21,7	168	80+	4000	2,6
Decor P LED1x4500 J278 T840 WGC LO2	1413	58	68	4479	26,8	167	80+	4000	2,6
Decor P LED1x5300 J279 T840 WGC LO3	1413	58	68	5278	32,0	165	80+	4000	2,6
Decor P LED1x6150 J280 T840 WGC LO4	1413	58	68	6147	37,8	163	80+	4000	2,6
Decor P LED1x5850 J281 T840 WGC LO1	2250	58	68	5840	33,3	175	80+	4000	4,0
Decor P LED1x7200 J282 T840 WGC LO2	2250	58	68	7166	41,9	171	80+	4000	4,0
Decor P LED1x8450 J283 T840 WGC LO3	2250	58	68	8446	50,6	167	80+	4000	4,0
Decor P LED1x9750 J284 T840 WGC LO4	2250	58	68	9734	59,0	165	80+	4000	4,0
Decor P LED1x7300 J285 T840 WGC LO1	2808	58	68	7300	41,6	175	80+	4000	5,0
Decor P LED1x9000 J286 T840 WGC LO2	2808	58	68	8957	52,4	171	80+	4000	5,0
Decor P LED1x10600 J287 T840 WGC LO3	2808	58	68	10557	62,6	169	80+	4000	5,0
Decor P LED1x12300 J288 T840 WGC LO4	2808	58	68	12293	73,3	168	80+	4000	5,0

PRODUCT	LENGTH, mm	WIDTH, mm	HEIGHT, mm	LUMINAIRE OUTPUT*, lm	SYSTEM POWER*, W	SYSTEM EFFICACY*, lm/W	CRI	CCT*, K	WEIGHT, kg
Decor P LED1x2700 J273 T840 BGC LO1	1134	58	68	2695	17,6	153	80+	4000	2,3
Decor P LED1x3350 J274 T840 BGC LO2	1134	58	68	3307	21,9	151	80+	4000	2,3
Decor P LED1x3900 J275 T840 BGC LO3	1134	58	68	3898	26,1	149	80+	4000	2,3
Decor P LED1x4500 J276 T840 BGC LO4	1134	58	68	4492	30,8	146	80+	4000	2,3
Decor P LED1x3400 J277 T840 BGC LO1	1413	58	68	3369	21,7	155	80+	4000	2,6
Decor P LED1x4150 J278 T840 BGC LO2	1413	58	68	4134	26,8	154	80+	4000	2,6
Decor P LED1x4900 J279 T840 BGC LO3	1413	58	68	4872	32,0	152	80+	4000	2,6
Decor P LED1x5700 J280 T840 BGC LO4	1413	58	68	5674	37,8	150	80+	4000	2,6
Decor P LED1x5400 J281 T840 BGC LO1	2250	58	68	5391	33,3	162	80+	4000	4,0
Decor P LED1x6650 J282 T840 BGC LO2	2250	58	68	6615	41,9	158	80+	4000	4,0
Decor P LED1x7800 J283 T840 BGC LO3	2250	58	68	7796	50,6	154	80+	4000	4,0
Decor P LED1x9000 J284 T840 BGC LO4	2250	58	68	8985	59,0	152	80+	4000	4,0
Decor P LED1x6750 J285 T840 BGC LO1	2808	58	68	6738	41,6	162	80+	4000	5,0
Decor P LED1x8300 J286 T840 BGC LO2	2808	58	68	8268	52,4	158	80+	4000	5,0
Decor P LED1x9750 J287 T840 BGC LO3	2808	58	68	9745	62,6	156	80+	4000	5,0
Decor P LED1x11350 J288 T840 BGC LO4	2808	58	68	11348	73,3	155	80+	4000	5,0

*Tolerance range for optical and electrical data: ±10%. Values apply to an ambient temperature of 25°C. NORTHCLIFFE LIGHTING is constantly developing and improving its products. The right is reserved to change any product specifications without prior notification

AVAILABLE ACCESSORIES:



Product: Suspension MTG KIT SUSI
Description: Suspension wire set "I" type, 1.5m adjustable, 1pcs
**note - at least 2pcs MTG KIT SUSI for one fitting required. For exact quantity please refer to installation manual*
**note - SUS option is required*



Product: CAP cable 3x0.75 2.0m clear
Description: Cable 3x0.75mm² for suspended luminaire up to 2.0 meters, transparent



Product: CAP cable clip D6.3mm SET clear
Description: Cable and suspension wire clip set, 4pcs. For cable diameter up to 6,3mm and wire diameter 1mm

Product: CAP4, light grey/ white/ black
Description: Square decorative metal cap for hiding cable inlet with suspension wire attachment point, push-in terminals 3x1x1.5mm², light grey/ white/ black



Product: CAP5, light grey/ white/ black
Description: Square decorative metal cap for hiding cable inlet with suspension wire attachment point, push-in terminals 5x1x1.5mm², light grey/ white/ black



Product: I-JOIN MTG KIT Decor LED RAL9006S
Description: "I" type joint kit for connecting luminaires in-line
**note - check RAL colour to match luminaire*



Product: T-JOIN MTG KIT Decor LED RAL9006S
Description: "T" type joint kit for connecting luminaires in-line
**note - check RAL colour to match luminaire*



Product: L-JOIN MTG KIT Decor LED RAL9006S
Description: "L" type joint kit for connecting luminaires in-line
**note - check RAL colour to match luminaire*



Product: X-JOIN MTG KIT Decor LED RAL9006S
Description: "X" type joint kit for connecting luminaires in-line
**note - check RAL colour to match luminaire*



Product: BLANK Decor LED L1000mm RAL9006S
Description: Blank DECOR LED kit for connecting luminaires in-line 1000mm long, 1pcs
**note - BLANK through wiring option must meet luminaire options*
**note - indicate needed length, location and RAL colour placing order*

BLANK Decor P LED with Capheus B LED
(ask for special model)



OPTIONS AVAILABLE ON REQUEST:

LED	REFLECTOR AND OPTICS	CONTROL GEAR	SENSORS	EMERGENCY	CONNECTION	OTHER	COLOUR
T830	WGC	DALI ¹	MW ⁴ 7	EM3	1LIN	L ¹⁰	RAL
T840	BGC	EAIRB-M ² 3 4 5 6	PIR ⁴ 8 9	EM3B	2LIN	LL ¹¹	
	WMC	EAIRB-S ⁵ 6		EM3A	3LIN	I-join L ^{12 13}	
	BMC	BLT		EM3D	CBF3-2.0m clear	I-join LL ^{12 13}	
	MGC	COR			CBF3-3.0m clear	L I-join LL ^{12 13}	
	MMC	COR1min			CBF5-2.0m clear	SUS	
	WAC/BAC	COR30min			CBF5-3.0m clear		

- 1 For DALI LIN option wires are 2x0.5mm²
- 2 Ingress protection IP20
- 3 For option EAIRB-M luminaire housing is 40mm longer
- 4 The EAIRB, MW, PIR sensors are positioned in the end of the luminaire for lengths up to 1800mm, and in the middle of the luminaire for lengths over 1800mm
- 5 Max system size 1x EAIRB-M + 3x EAIRB-S
- 6 Max wire length from EAIRB-M to last EAIRB-S - 11 m
- 7 For option MW luminaire housing is 72mm longer
- 8 Ingress protection IP40
- 9 For option PIR luminaire housing is 50mm longer
- 10 First/end luminaire, body is 7mm shorter than standalone version
- 11 In-line luminaire, body is 14mm shorter than standalone version
- 12 For I-join L, I-join LL and L I-join LL models joint kit not included, 1LIN option included
- 13 Intermediate luminaire must have I-JOIN L, I-JOIN LL or L I-JOIN LL options, depending on installation position

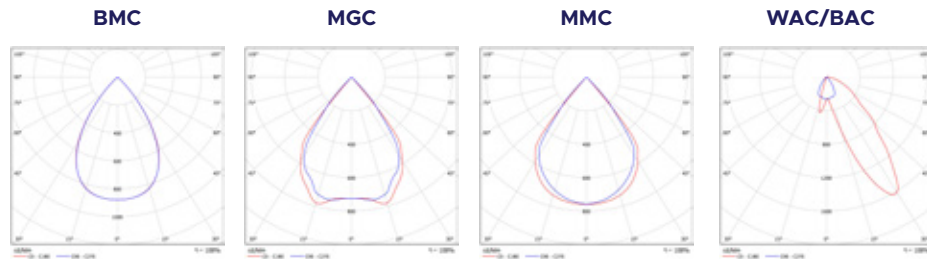
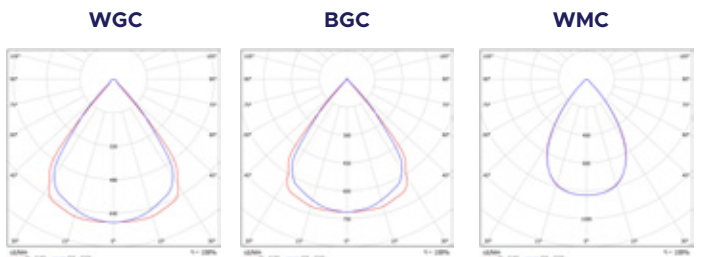

DECOR O LED

Aluminium Profile Luminaires



DESCRIPTION: Surface mounted or suspended slim profile LED luminaire for in-line connection
Light distribution type: direct
Optical system: lenses, low glare
Housing: aluminium
Colour: light grey, RAL9006S; white, RAL9003S; black, RAL9005S

GENERAL DATA: Mains voltage: 220-240V, 0/50-60Hz
LED lifetime, h: 100000/L80B10
SDCM: 3
Protection class IEC: I
Ingress protection code: IP40
Mechanical impact resistance: IK05
Operating temperature range, °C: ta 0...+35

INSTALLATION: On the ceiling or suspended (wire, cable and cap to be ordered separately), with L/LL option is designed for in-line connection. Push-in terminal, 3x2x2.5mm²

ENVIRONMENT: Indoor

APPLICATION: Office, education, hotel, corridor, retail, public place

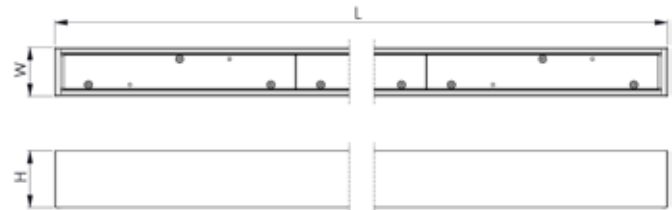

PRODUCT	LENGTH, mm	WIDTH, mm	HEIGHT, mm	LUMINAIRE OUTPUT*, lm	SYSTEM POWER*, W	SYSTEM EFFICACY*, lm/W	CRI	CCT*, K	WEIGHT, kg
Decor O LED1x3800 J292 T840 L75 LO1	1148	58	68	3796	21,8	174	80+	4000	2,3
Decor O LED1x5300 J293 T840 L75 LO2	1148	58	68	5260	31,7	166	80+	4000	2,3
Decor O LED1x5550 J294 T840 L75 LO3	1148	58	68	5523	30,0	184	80+	4000	2,3
Decor O LED1x6600 J295 T840 L75 LO4	1148	58	68	6567	35,9	183	80+	4000	2,3
Decor O LED1x7600 J296 T840 L75 LO5	1148	58	68	7554	41,6	182	80+	4000	2,3
Decor O LED1x4750 J297 T840 L75 LO1	1428	58	68	4746	27,0	176	80+	4000	2,6
Decor O LED1x6600 J298 T840 L75 LO2	1428	58	68	6575	38,7	170	80+	4000	2,6
Decor O LED1x6950 J299 T840 L75 LO3	1428	58	68	6904	36,7	188	80+	4000	2,6
Decor O LED1x8250 J300 T840 L75 LO4	1428	58	68	8209	44,4	185	80+	4000	2,6
Decor O LED1x9450 J301 T840 L75 LO5	1428	58	68	9442	51,5	183	80+	4000	2,6
Decor O LED1x9500 J302 T840 L75 LO1	2831	58	68	9491	51,6	184	80+	4000	5,0
Decor O LED1x13150 J303 T840 L75 LO2	2831	58	68	13150	75,0	175	80+	4000	5,0
Decor O LED1x13850 J304 T840 L75 LO3	2831	58	68	13808	72,7	190	80+	4000	5,0
Decor O LED1x16450 J305 T840 L75 LO4	2831	58	68	16418	87,0	189	80+	4000	5,0
Decor O LED1x18900 J306 T840 L75 LO5	2831	58	68	18884	101,9	185	80+	4000	5,0

*Tolerance range for optical and electrical data: ±10%. Values apply to an ambient temperature of 25°C. NORTHCLIFFE LIGHTING is constantly developing and improving its products. The right is reserved to change any product specifications without prior notification

AVAILABLE ACCESSORIES:



Product: Suspension MTG KIT SUSI
Description: Suspension wire set "I" type, 1.5m adjustable, 1pcs
**note - 2pcs MTG SUSI KIT for length up to 2000mm, 3pcs MTG SUSI KIT for lengths 2000 - 3000mm*
**note - SUS option is required*



Product: CAP cable 3x0.75 2.0m clear
Description: Cable 3x0.75mm² for suspended luminaire up to 2.0 meters, transparent



Product: CAP cable clip D6.3mm SET clear
Description: Cable and suspension wire clip set, 4pcs. For cable diameter up to 6,3mm and wire diameter 1mm



Product: CAP4, light grey/ white/ black
Description: Square decorative metal cap for hiding cable inlet with suspension wire attachment point, push-in terminals 3x1x1.5mm², light grey/ white/ black



Product: I-JOIN MTG KIT Decor LED RAL9006S
Description: "I" type joint kit for connecting luminaires in-line
**note - check RAL colour to match luminaire*

Product: CAP5, light grey/ white/ black
Description: Square decorative metal cap for hiding cable inlet with suspension wire attachment point, push-in terminals 5x1x1.5mm², light grey/ white/ black



Product: L-JOIN MTG KIT Decor LED RAL9006S
Description: "L" type joint kit for connecting luminaires in-line
**note - check RAL colour to match luminaire*



Product: T-JOIN MTG KIT Decor LED RAL9006S
Description: "T" type joint kit for connecting luminaires in-line
**note - check RAL colour to match luminaire*



Product: X-JOIN MTG KIT Decor LED RAL9006S
Description: "X" type joint kit for connecting luminaires in-line
**note - check RAL colour to match luminaire*



Product: BLANK Decor LED L1000mm RAL9006S
Description: Blank DECOR LED kit for connecting luminaires in-line 1000mm long, 1pcs
**note - BLANK through wiring option must meet luminaire options*
**note - indicate needed length, location and RAL colour placing order*

BLANK Decor O LED with Capheus B LED
(ask for special model)



OPTIONS AVAILABLE ON REQUEST:

LED	REFLECTOR AND OPTICS	CONTROL GEAR	SENSORS	EMERGENCY	CONNECTION	OTHER	COLOUR
T830	L30	DALI ¹	MW ^{4 7}	EM3	1LIN	L	RAL
T840	L40x75	EAIRB-M ^{2 3 4 5 6}	PIR ^{4 8 9}	EM3B	2LIN	LL	
	L75	EAIRB-S ^{5 6}		EM3A	3LIN	I-join L ^{10 11}	
	L75W	BLT		EM3D	CBF3-2.0m clear	I-join LL ^{10 11}	
	L90W	COR			CBF3-3.0m clear	L I-join LL ^{10 11}	
	L100	COR1min			CBF5-2.0m clear	SUS ¹²	
	L1A18-L	COR30min			CBF5-3.0m clear		
	L1A18-R						
	L2A25						

1 For DALI LIN option wires are 2x0.5mm²
 2 Ingress protection IP20
 3 For option EAIRB-M luminaire housing is 40mm longer
 4 The EAIRB, MW, PIR sensors are positioned in the end of the luminaire for lengths up to 1800mm, and in the middle of the luminaire for lengths over 1800mm
 5 Max system size 1x EAIRB-M + 3x EAIRB-S
 6 Max wire length from EAIRB-M to last EAIRB-S - 11 m
 7 For option MW luminaire housing is 72mm longer
 8 Ingress protection IP40
 9 For option PIR luminaire housing is 50mm longer
 10 For I-join L; I-join LL and L I-join LL models joint kit not included, 1LIN option included
 11 Intermediate luminaire must have I-JOIN L, I-JOIN LL or L I-JOIN LL options, depending on installation position
 12 For suspended luminaires it is recommended to use one of CBF option for easier mounting

L30

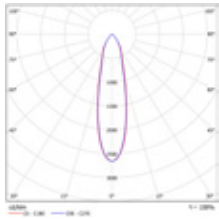

L40x75

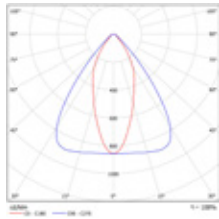

L75

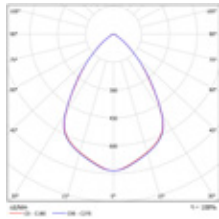

L75W

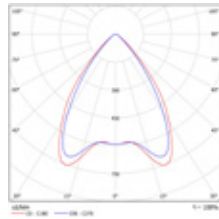

L90W

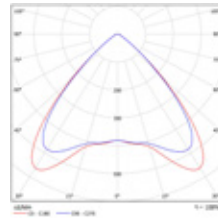

L100

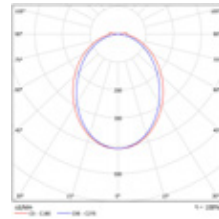

L1A18-L

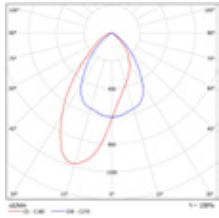

L1A18-R

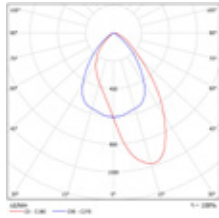

L2A25

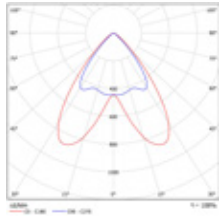

DECOR L LED

Aluminum Profile Luminaires

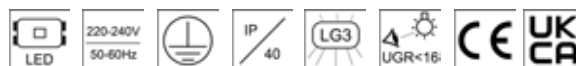

DESCRIPTION: **Suspended middle profile LED luminaire for in-line connection**

Light distribution type: direct/indirect
Optical system: opal polycarbonate diffuser / matt micro-prismatic polycarbonate diffuser, low glare
Housing: aluminium
Colour: light grey, RAL9006S; white, RAL9003S; black, RAL9005S

GENERAL DATA: **Mains voltage:** 220-240V, 0/50-60Hz
LED lifetime, h: 50000/L80B10
SDCM: 3
Protection class IEC: I
Ingress protection code: IP40
Mechanical impact resistance: IK05
Glow wire test, °C: 650
Operating temperature range, °C: ta 0...+35

INSTALLATION: Suspended (wire, cable and cap to be ordered separately), with L/LL option is designed for in-line connection. Push-in terminal, 3x2x2.5mm²

ENVIRONMENT: Indoor

APPLICATION: Office, education, hotel, retail, public place

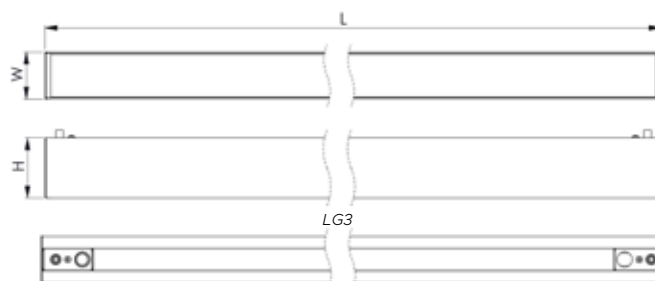

PRODUCT	LENGTH, mm	WIDTH, mm	HEIGHT, mm	LUMINAIRE OUTPUT*, lm	SYSTEM POWER*, W	SYSTEM EFFICACY*, lm/W	CRI	CCT*, K	WEIGHT, kg
Decor L LED1x1650/1050 G408 T840 OP LG3 LO1 SUS	1135	58	75	2644	21,0	125	80+	4000	2,7
Decor L LED1x2200/1450 G409 T840 OP LG3 LO2 SUS	1135	58	75	3604	29,4	122	80+	4000	2,7
Decor L LED1x3050/1950 G410 T840 OP LG3 LO3 SUS	1135	58	75	4953	43,1	114	80+	4000	2,7
Decor L LED1x2050/1400 G411 T840 OP LG3 LO1 SUS	1415	58	75	3392	26,4	128	80+	4000	3,2
Decor L LED1x2750/1900 G412 T840 OP LG3 LO2 SUS	1415	58	75	4622	37,8	122	80+	4000	3,2
Decor L LED1x3800/2600 G413 T840 OP LG3 LO3 SUS	1415	58	75	6354	54,9	116	80+	4000	3,2
Decor L LED1x1450/1050 G408 T840 DPRZ LT80 LG3 LO1 SUS	1135	58	75	2441	21,0	117	80+	4000	2,7
Decor L LED1x1950/1450 G409 T840 DPRZ LT80 LG3 LO2 SUS	1135	58	75	3327	29,4	114	80+	4000	2,7
Decor L LED1x2650/1950 G410 T840 DPRZ LT80 LG3 LO3 SUS	1135	58	75	4572	43,1	107	80+	4000	2,7
Decor L LED1x1800/1400 G411 T840 DPRZ LT80 LG3 LO1 SUS	1415	58	75	3138	26,4	120	80+	4000	3,2
Decor L LED1x2400/1900 G412 T840 DPRZ LT80 LG3 LO2 SUS	1415	58	75	4276	37,8	114	80+	4000	3,2
Decor L LED1x3300/2600 G413 T840 DPRZ LT80 LG3 LO3 SUS	1415	58	75	5878	54,9	108	80+	4000	3,2

*Tolerance range for optical and electrical data: ±10%. Values apply to an ambient temperature of 25°C. NORTHCLIFFE LIGHTING is constantly developing and improving its products. The right is reserved to change any product specifications without prior notification

AVAILABLE ACCESSORIES:



Product: Suspension MTG KIT SUSI
Description: Suspension wire set "I" type, 1.5m adjustable, 1pcs
**note - 2pcs MTG SUSI KIT for length up to 2000mm*



Product: CAP cable clip D6.3mm SET clear
Description: Cable and suspension wire clip set, 4pcs. For cable diameter up to 6,3mm and wire diameter 1mm



Product: CAP cable 3x0.75 2.0m clear
Description: Cable 3x0.75mm² for suspended luminaire up to 2.0 meters, transparent



Product: CAP4, light grey/ white/ black
Description: Square decorative metal cap for hiding cable inlet with suspension wire attachment point, push-in terminals 3x1x1.5mm², light grey/ white/ black



Product: CAP5, light grey/ white/ black
Description: Square decorative metal cap for hiding cable inlet with suspension wire attachment point, push-in terminals 5x1x1.5mm², light grey/ white/ black

Product: WALL MTG KIT - Decor L/LP LED RAL9006S (P)
Description: Support bracket for luminaire installation onto wall. Decor L/LP LED, 1pcs
**note - 2pcs WALL MTG KIT for length up to 2000mm*

OPTIONS AVAILABLE ON REQUEST:

LED	REFLECTOR AND OPTICS	CONTROL GEAR	SENSORS	EMERGENCY	CONNECTION	OTHER	COLOUR
T830	OP	DALI ¹	MW ^{4 6}	EM3 ^{8 9}	1LIN	L ^{10 11}	RAL
T840	DPRZ LT80	DALIsep ¹	PIR ^{4 7}	EM3B ^{8 9}	2LIN	LL ^{10 12}	
		EAIRB ^{2 3 4}		EM3A ^{8 9}	3LIN		
		BLT		EM3D ^{8 9}	2G		
		TW			CBF3-2.0m clear		
		PULL ⁵			CBF3-3.0m clear		
		PULLDIM ⁵			CBF5-2.0m clear		
		Lsep			CBF5-3.0m clear		

- 1 For DALI LIN option wires are 2x0.5mm²
- 2 Ingress protection IP20
- 3 For options EAIRB luminaire housing is 65mm longer
- 4 The EAIRB, MW and PIR sensors are positioned in the end of the luminaire for lengths up to 1800mm, and in the middle of the luminaire for lengths over 1800mm
- 5 For PULL and PULLDIM options luminaire housing is 50mm longer and switch is positioned at the end of luminaire
- 6 For option MW luminaire housing is 72mm longer
- 7 For option PIR luminaire housing is 50mm longer
- 8 EM options applicable for models longer than 1000mm
- 9 Operating temperature range for Luminaires with EM option, °C: ta 0... +35
- 10 For L and LL models joint kit and 1LIN option included (5TB option for lengths up to 800mm)
- 11 First/end luminaire, body is 7mm shorter than standalone version
- 12 In-line luminaire, body is 14mm shorter than standalone version

OP LG3

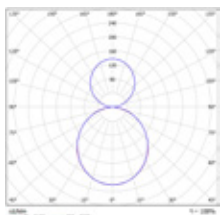

DPRZ LT80 LG3

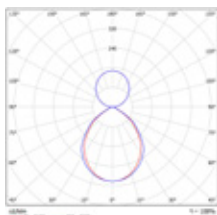

DECOR L LED CORNER90

Aluminum Profile Luminaires

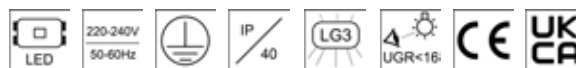

DESCRIPTION: **Suspended middle profile LED luminaire for in-line connection**
Light distribution type: direct/indirect
Optical system: opal polycarbonate / matt micro-prismatic polycarbonate diffuser, low glare
Housing: aluminium
Colour: light grey, RAL9006S; white, RAL9003S; black, RAL9005S

GENERAL DATA: **Mains voltage:** 220-240V, 0/50-60Hz
LED lifetime, h: 50000/L80B10
SDCM: 3
Protection class IEC: I
Ingress protection code: IP40
Mechanical impact resistance: IK05
Operating temperature range, °C: ta 0...+35

INSTALLATION: Suspended (wire, cable and cap to be ordered separately), with L/LL option is designed for in-line connection. Through wired, 3x1.5mm², push-in terminal, 3x2x2.5mm² and supply cord

ENVIRONMENT: Indoor

APPLICATION: Office, education, hotel, retail, public place

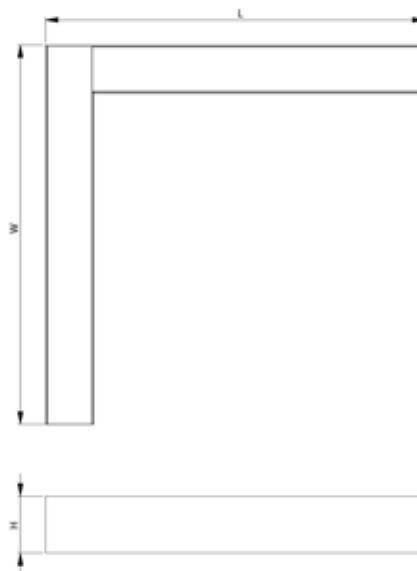

PRODUCT	LENGTH, mm	WIDTH, mm	HEIGHT, mm	LUMINAIRE OUTPUT*, lm	SYSTEM POWER*, W	SYSTEM EFFICACY*, lm/W	CRI	CCT*, K	WEIGHT, kg
DECOR L LED1x1250/700 J289 T840 OP LG3 LO1 1LIN LL CORNER90 SUS	455	455	75	1898	16,1	118	80+	4000	2,4
DECOR L LED1x1650/950 J290 T840 OP LG3 LO2 1LIN LL CORNER90 SUS	455	455	75	2584	22,4	115	80+	4000	2,4
DECOR L LED1x2300/1300 J291 T840 OP LG3 LO3 1LIN LL CORNER90 SUS	455	455	75	3553	32,5	109	80+	4000	2,4
DECOR L LED1x1100/700 J289 T840 DPRZ LT80 LG3 LO1 1LIN LL CORNER90 SUS	455	455	75	1745	16,1	108	80+	4000	2,4
DECOR L LED1x1450/950 J290 T840 DPRZ LT80 LG3 LO2 1LIN LL CORNER90 SUS	455	455	75	2377	22,4	106	80+	4000	2,4
DECOR L LED1x2000/1300 J291 T840 DPRZ LT80 LG3 LO3 1LIN LL CORNER90 SUS	455	455	75	3267	32,5	101	80+	4000	2,4

*Tolerance range for optical and electrical data: ±10%. Values apply to an ambient temperature of 25°C. NORTHCLIFFE LIGHTING is constantly developing and improving its products. The right is reserved to change any product specifications without prior notification

AVAILABLE ACCESSORIES:



Product: Suspension MTG KIT SUSI
Description: Suspension wire set "I" type, 1.5m adjustable, 1pcs
**note - at least 2pcs MTG KIT SUSI for one fitting required. For exact quantity please refer to installation manual*



Product: CAP cable 3x0.75 2.0m clear
Description: Cable 3x0.75mm² for suspended luminaire up to 2.0 meters, transparent



Product: CAP4, light grey/ white/ black
Description: Square decorative metal cap for hiding cable inlet with suspension wire attachment point, push-in terminals 3x1x1.5mm², light grey/ white/ black



Product: CAP cable clip D6.3mm SET clear
Description: Cable and suspension wire clip set, 4pcs. For cable diameter up to 6,3mm and wire diameter 1mm

Product: CAP5, light grey/ white/ black
Description: Square decorative metal cap for hiding cable inlet with suspension wire attachment point, push-in terminals 5x1x1.5mm², light grey/ white/ black

OPTIONS AVAILABLE ON REQUEST:

LED	REFLECTOR AND OPTICS	CONTROL GEAR	CONNECTION	COLOUR
T830	OP	DALI	1LIN	RAL
T840	DPRZ LT80	EAIRB-S ¹ 2	2LIN	
		BLT	3LIN	
			CBF3-2.0m clear	
			CBF3-3.0m clear	
			CBF5-2.0m clear	
			CBF5-3.0m clear	

- 1 Max system size 1x EAIRB-M + 3x EAIRB-S
- 2 Max wire length from EAIRB-M to last EAIRB-S - 11 m

OP LG3

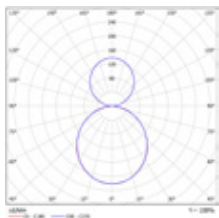

DPRZ LT80 LG3

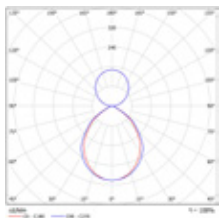

DECOR LP LED

Aluminum Profile Luminaires

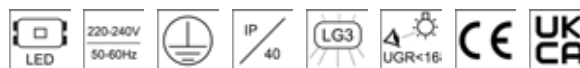

DESCRIPTION: **Suspended middle profile LED luminaire for in-line connection**

Light distribution type: direct/indirect

Optical system: double parabolic reflector with lenses, low glare

Housing: aluminium

Colour: light grey, RAL9006S; white, RAL9003S; black, RAL9005S

GENERAL DATA: **Mains voltage:** 220-240V, 0/50-60Hz

LED lifetime, h: 100000/L80B10

SDCM: 3

Protection class IEC: I

Ingress protection code: IP40

Mechanical impact resistance: IK05

Operating temperature range, °C: ta 0...+35

INSTALLATION: Suspended (wire, cable and cap to be ordered separately), with L/LL option is designed for in-line connection. Push-in terminal, 3x2x2.5mm²

ENVIRONMENT: Indoor

APPLICATION: Office, education, retail, public place

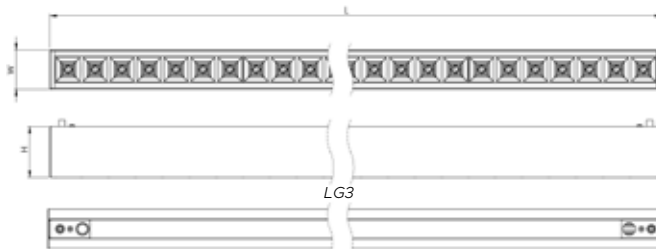

PRODUCT	LENGTH, mm	WIDTH, mm	HEIGHT, mm	LUMINAIRE OUTPUT*, lm	SYSTEM POWER*, W	SYSTEM EFFICACY*, lm/W	CRI	CCT*, K	WEIGHT, kg
DECOR LP LED1x2950/1050 J322 T840 WGC LG3 LO1	1134	58	75	3966	25,5	156	80+	4000	2,7
DECOR LP LED1x3600/1300 J323 T840 WGC LG3 LO2	1134	58	75	4868	32,2	151	80+	4000	2,7
DECOR LP LED1x4250/1550 J324 T840 WGC LG3 LO3	1134	58	75	5738	38,5	149	80+	4000	2,7
DECOR LP LED1x4900/1800 J325 T840 WGC LG3 LO4	1134	58	75	6618	45,3	146	80+	4000	2,7
DECOR LP LED1x3650/1300 J326 T840 WGC LG3 LO1	1413	58	75	4905	31,8	154	80+	4000	3,2
DECOR LP LED1x4500/1550 J327 T840 WGC LG3 LO2	1413	58	75	6021	39,7	152	80+	4000	3,2
DECOR LP LED1x5300/1850 J328 T840 WGC LG3 LO3	1413	58	75	7095	48,0	148	80+	4000	3,2
DECOR LP LED1x6150/2100 J329 T840 WGC LG3 LO4	1413	58	75	8247	56,1	147	80+	4000	3,2
DECOR LP LED1x5850/2100 J330 T840 WGC LG3 LO1	2250	58	75	7932	49,9	159	80+	4000	5,3
DECOR LP LED1x7200/2600 J331 T840 WGC LG3 LO2	2250	58	75	9737	62,3	156	80+	4000	5,3
DECOR LP LED1x8450/3050 J332 T840 WGC LG3 LO3	2250	58	75	11476	75,3	152	80+	4000	5,3
DECOR LP LED1x9750/3550 J333 T840 WGC LG3 LO4	2250	58	75	13237	88,8	149	80+	4000	5,3
DECOR LP LED1x7300/2550 J334 T840 WGC LG3 LO1	2808	58	75	9810	61,6	159	80+	4000	6,6
DECOR LP LED1x9000/3100 J335 T840 WGC LG3 LO2	2808	58	75	12041	77,7	155	80+	4000	6,6
DECOR LP LED1x10600/3650 J336 T840 WGC LG3 LO3	2808	58	75	14192	94,0	151	80+	4000	6,6
DECOR LP LED1x12300/4250 J337 T840 WGC LG3 LO4	2808	58	75	16494	111,1	148	80+	4000	6,6

PRODUCT	LENGTH, mm	WIDTH, mm	HEIGHT, mm	LUMINAIRE OUTPUT*, lm	SYSTEM POWER*, W	SYSTEM EFFICACY*, lm/W	CRI	CCT*, K	WEIGHT, kg
DECOR LP LED1x2700/1050 J322 T840 BGC LG3 LO1	1134	58	75	3741	25,5	147	80+	4000	2,7
DECOR LP LED1x3350/1300 J323 T840 BGC LG3 LO2	1134	58	75	4592	32,2	143	80+	4000	2,7
DECOR LP LED1x3900/1550 J324 T840 BGC LG3 LO3	1134	58	75	5413	38,5	141	80+	4000	2,7
DECOR LP LED1x4500/1800 J325 T840 BGC LG3 LO4	1134	58	75	6243	45,3	138	80+	4000	2,7
DECOR LP LED1x3400/1300 J326 T840 BGC LG3 LO1	1413	58	75	4624	31,8	145	80+	4000	3,2
DECOR LP LED1x4150/1550 J327 T840 BGC LG3 LO2	1413	58	75	5676	39,7	143	80+	4000	3,2
DECOR LP LED1x4900/1850 J328 T840 BGC LG3 LO3	1413	58	75	6689	48,0	139	80+	4000	3,2
DECOR LP LED1x5700/2100 J329 T840 BGC LG3 LO4	1413	58	75	7774	56,1	139	80+	4000	3,2
DECOR LP LED1x5400/2100 J330 T840 BGC LG3 LO1	2250	58	75	7483	49,9	150	80+	4000	5,3
DECOR LP LED1x6650/2600 J331 T840 BGC LG3 LO2	2250	58	75	9186	62,3	147	80+	4000	5,3
DECOR LP LED1x7800/3050 J332 T840 BGC LG3 LO3	2250	58	75	10826	75,3	144	80+	4000	5,3
DECOR LP LED1x9000/3550 J333 T840 BGC LG3 LO4	2250	58	75	12488	88,8	141	80+	4000	5,3
DECOR LP LED1x6750/2550 J334 T840 BGC LG3 LO1	2808	58	75	9248	61,6	150	80+	4000	6,6
DECOR LP LED1x8300/3100 J335 T840 BGC LG3 LO2	2808	58	75	11352	77,7	146	80+	4000	6,6
DECOR LP LED1x9750/3650 J336 T840 BGC LG3 LO3	2808	58	75	13380	94,0	142	80+	4000	6,6
DECOR LP LED1x11350/4250 J337 T840 BGC LG3 LO4	2808	58	75	15549	111,1	140	80+	4000	6,6

*Tolerance range for optical and electrical data: ±10%. Values apply to an ambient temperature of 25°C. NORTHCLIFFE LIGHTING is constantly developing and improving its products. The right is reserved to change any product specifications without prior notification

AVAILABLE ACCESSORIES:



Product: Suspension MTG KIT SUSI
Description: Suspension wire set "I" type, 1.5m adjustable, 1pcs
**note - at least 2pcs MTG KIT SUSI for one fitting required. For exact quantity please refer to installation manual*



Product: CAP4, light grey/ white/ black
Description: Square decorative metal cap for hiding cable inlet with suspension wire attachment point, push-in terminals 3x1x1.5mm², light grey/ white/ black

Product: CAP5, light grey/ white/ black
Description: Square decorative metal cap for hiding cable inlet with suspension wire attachment point, push-in terminals 5x1x1.5mm², light grey/ white/ black



Product: CAP cable 3x0.75 2.0m clear
Description: Cable 3x0.75mm² for suspended luminaire up to 2.0 meters, transparent



Product: CAP cable clip D6.3mm SET clear
Description: Cable and suspension wire clip set, 4pcs. For cable diameter up to 6,3mm and wire diameter 1mm

Product: WALL MTG KIT - Decor L/LP LED RAL9006S (P)
Description: Support bracket for luminaire installation onto wall. Decor L/LP LED, 1pcs
**note - 2pcs WALL MTG KIT for length up to 2000mm*

OPTIONS AVAILABLE ON REQUEST:

LED	REFLECTOR AND OPTICS	CONTROL GEAR	SENSORS	EMERGENCY	CONNECTION	OTHER	COLOUR
T830	WGC	DALI	MW ^{6 7}	EM3	1LIN	L ⁹	RAL
T840	BGC	DALIsep	PIR ^{7 8}	EM3B	2LIN	LL ¹⁰	
	WMC	EAIRB-M ^{1 2 3 4}		EM3A	3LIN		
	BMC	EAIRB-S ^{2 3 4}		EM3D	CBF3-2.0m clear		
	MGC	BLT			CBF3-3.0m clear		
	MMC	PULL ⁵			CBF5-2.0m clear		
		PULLDIM ⁵			CBF5-3.0m clear		
		Lsep					

- For EAIRB-M option ingress protection IP20
- Please ask for special models with options EAIRB
- Max system size 1x EAIRB-M + 3x EAIRB-S
- Max wire length from EAIRB-M to last EAIRB-S - 11 m
- For PULL and PULLDIM options luminaire housing is 50mm longer and switch is positioned at the end of luminaire
- For option MW luminaire housing is 72mm longer
- The MW and PIR sensors are positioned in the end of the luminaire for lengths up to 1800mm, and in the middle of the luminaire for lengths over 1800mm
- For option PIR luminaire housing is 50mm longer
- First/end luminaire, body is 7mm shorter than standalone version
- In-line luminaire, body is 14mm shorter than standalone version

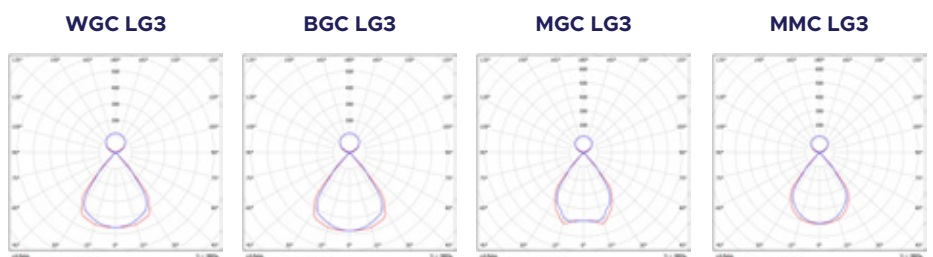

DECOR LO LED

Aluminum Profile Luminaires

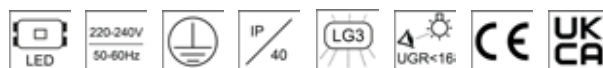

DESCRIPTION: Suspended slim profile LED luminaire for in-line connection

Light distribution type: direct/indirect

Optical system: lenses

Housing: aluminium

Colour: light grey, RAL9006S; white, RAL9003S; black, RAL9005S

GENERAL DATA: Mains voltage: 220-240V, 0/50-60Hz

LED lifetime, h: 100000/L80B10

SDCM: 3

Protection class IEC: I

Ingress protection code: IP40

Mechanical impact resistance: IK05

Operating temperature range, °C: ta 0...+35

INSTALLATION: Suspended (wire, cable and cap to be ordered separately), with L/LL option is designed for in-line connection. Push-in terminal, 3x2x2.5mm²

ENVIRONMENT: Indoor

APPLICATION: Office, education, retail, public place

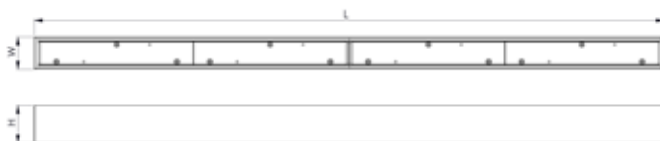

PRODUCT	LENGTH, mm	WIDTH, mm	HEIGHT, mm	LUMINAIRE OUTPUT*, lm	SYSTEM POWER*, W	SYSTEM EFFICACY*, lm/W	CRI	CCT*, K	WEIGHT, kg
DECOR LO LED1x3800/1800 J338 T840 L75 LG3 LO1	1148	58	75	5563	37,3	149	80+	4000	2,7
DECOR LO LED1x5300/2450 J339 T840 L75 LG3 LO2	1148	58	75	7689	53,2	145	80+	4000	2,7
DECOR LO LED1x4750/2150 J340 T840 L75 LG3 LO1	1428	58	75	6866	44,8	153	80+	4000	3,2
DECOR LO LED1x6600/2950 J341 T840 L75 LG3 LO2	1428	58	75	9490	64,6	147	80+	4000	3,2
DECOR LO LED1x9500/4250 J342 T840 L75 LG3 LO1	2831	58	75	13732	87,6	157	80+	4000	6,6
DECOR LO LED1x13150/5850 J343 T840 L75 LG3 LO2	2831	58	75	18980	126,5	150	80+	4000	6,6

*Tolerance range for optical and electrical data: ±10%. Values apply to an ambient temperature of 25°C. NORTHCLIFFE LIGHTING is constantly developing and improving its products. The right is reserved to change any product specifications without prior notification

AVAILABLE ACCESSORIES:



Product: Suspension MTG KIT SUSI
Description: Suspension wire set "I" type, 1.5m adjustable, 1pcs
**note - at least 2pcs MTG KIT SUSI for one fitting required. For exact quantity please refer to installation manual*



Product: CAP4, light grey/ white/ black
Description: Square decorative metal cap for hiding cable inlet with suspension wire attachment point, push-in terminals 3x1x1.5mm², light grey/ white/ black

Product: CAP5, light grey/ white/ black
Description: Square decorative metal cap for hiding cable inlet with suspension wire attachment point, push-in terminals 5x1x1.5mm², light grey/ white/ black



Product: CAP cable 3x0.75 2.0m clear
Description: Cable 3x0.75mm² for suspended luminaire up to 2.0 meters, transparent



Product: CAP cable clip D6.3mm SET clear
Description: Cable and suspension wire clip set, 4pcs. For cable diameter up to 6.3mm and wire diameter 1mm



Product: WALL MTG KIT - Decor L/LP LED RAL9006S (P)
Description: Support bracket for luminaire installation onto wall. Decor L/LP LED, 1pcs
**note - 2pcs WALL MTG KIT for length up to 2000mm*

OPTIONS AVAILABLE ON REQUEST:

LED	REFLECTOR AND OPTICS	CONTROL GEAR	SENSORS	EMERGENCY	CONNECTION	OTHER	COLOUR
T830	L30	DALI	MW ⁶ 7	EM3	1LIN	L ⁹	RAL
T840	L40x75	DALIsép	PIR ⁷ 8	EM3B	2LIN	LL ¹⁰	
	L75	EAIRB-M ^{1 2 3 4}		EM3A	3LIN		
	L75W	EAIRB-S ^{2 3 4}		EM3D	CBF3-2.0m clear		
	L90W	BLT			CBF3-3.0m clear		
	L1A18-L	PULL ⁵			CBF5-2.0m clear		
	L1A18-R	PULLDIM ⁵			CBF5-3.0m clear		
	L2A25	Lsep					

- 1 For EAIRB-M option ingress protection IP20
- 2 Please ask for special models with options EAIRB
- 3 Max system size 1x EAIRB-M + 3x EAIRB-S
- 4 Max wire length from EAIRB-M to last EAIRB-S - 11 m
- 5 For PULL and PULLDIM options luminaire housing is 50mm longer and switch is positioned at the end of luminaire
- 6 For option MW luminaire housing is 72mm longer
- 7 The MW and PIR sensors are positioned in the end of the luminaire for lengths up to 1800mm, and in the middle of the luminaire for lengths over 1800mm
- 8 For option PIR luminaire housing is 50mm longer
- 9 First/end luminaire, body is 7mm shorter than standalone version
- 10 In-line luminaire, body is 14mm shorter than standalone version

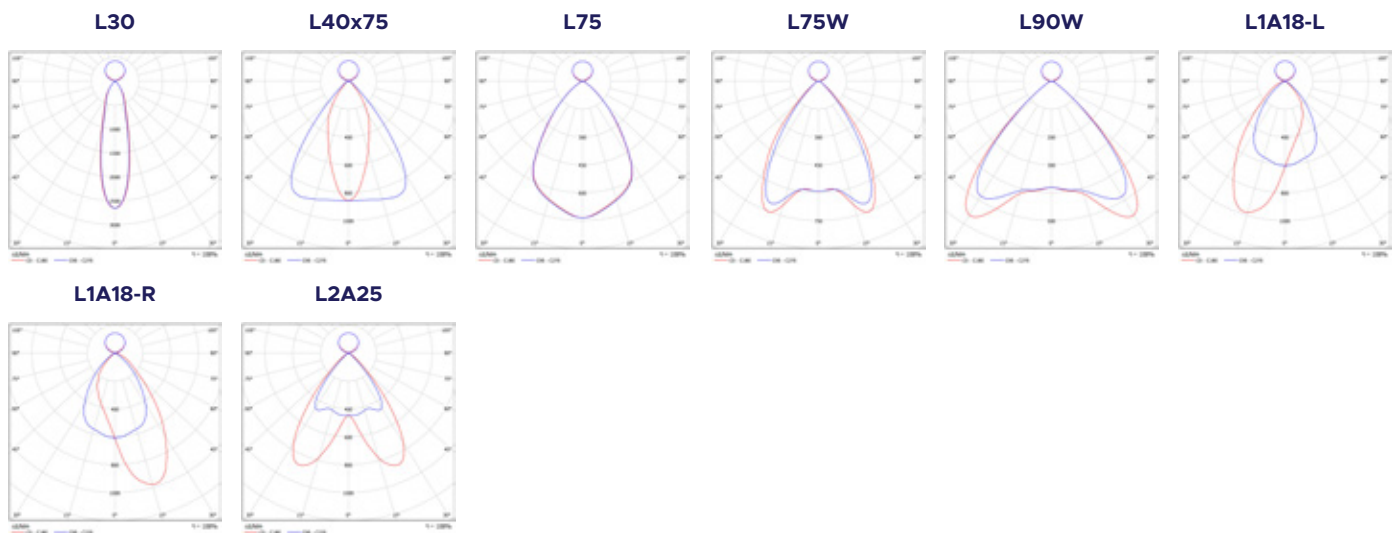

QUADRO LED

Aluminum Profile Luminaires

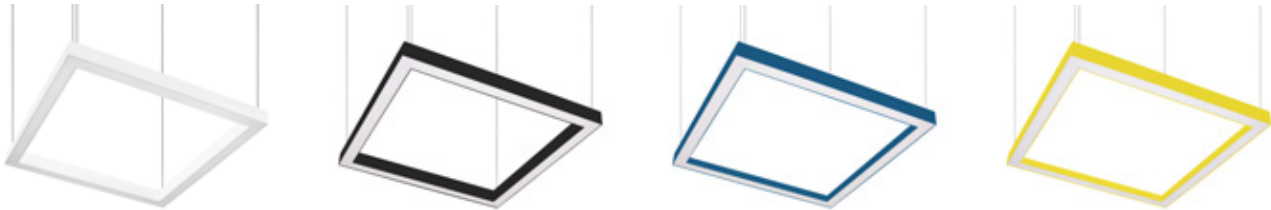
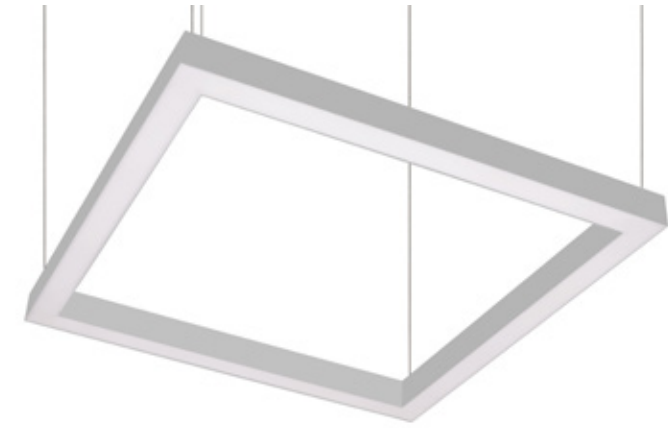

DESCRIPTION: **Suspended decorative LED luminaire**
Light distribution type: direct
Optical system: opal polycarbonate diffuser / matt micro-prismatic polycarbonate diffuser, low glare
Housing: aluminium
Colour: light grey, RAL9006S; white, RAL9003S; black, RAL9005S

GENERAL DATA: **Mains voltage:** 220-240V, 0/50-60Hz
LED lifetime, h: 50000/L80B10
SDCM: 3
Protection class IEC: I
Ingress protection code: IP40
Mechanical impact resistance: IK05
Operating temperature range, °C: ta 0...+35

INSTALLATION: Suspended (wire and cap to be ordered separately). Cable 2.0m, 3x0.75mm², transparent

ENVIRONMENT: Indoor

APPLICATION: Office, education, retail, public place

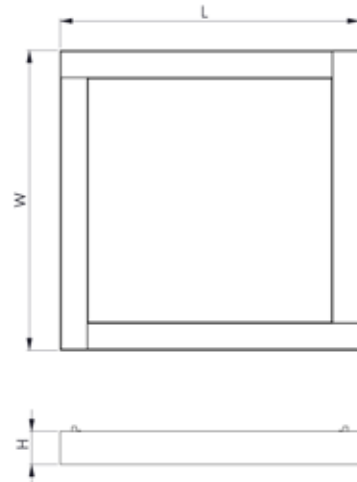

PRODUCT	LENGTH, mm	WIDTH, mm	HEIGHT, mm	LUMINAIRE OUTPUT*, lm	SYSTEM POWER*, W	SYSTEM EFFICACY*, lm/W	CRI	CCT*, K	WEIGHT, kg
Quadro LED1x3250 J344 T840 OP	620	620	68	3214	24,8	130	80+	4000	4,6
Quadro LED1x4400 J345 T840 OP	620	620	68	4380	34,7	126	80+	4000	4,6
Quadro LED1x6050 J346 T840 OP	620	620	68	6021	50,9	118	80+	4000	4,6
Quadro LED1x4550 D906 T840 OP	900	900	68	4542	36,4	125	80+	4000	6,6
Quadro LED1x6200 D907 T840 OP	900	900	68	6181	52,5	118	80+	4000	6,6
Quadro LED1x8400 D908 T840 OP	900	900	68	8383	77,8	108	80+	4000	6,6
Quadro LED1x6100 D909 T840 OP	1180	1180	68	6056	48,5	125	80+	4000	8,8
Quadro LED1x8250 D910 T840 OP	1180	1180	68	8241	70,0	118	80+	4000	8,8
Quadro LED1x11200 D911 T840 OP	1180	1180	68	11177	103,7	108	80+	4000	8,8
Quadro LED1x2850 J344 T840 DPRZ LT80	620	620	68	2807	24,8	113	80+	4000	4,6
Quadro LED1x3850 J345 T840 DPRZ LT80	620	620	68	3825	34,7	110	80+	4000	4,6
Quadro LED1x5300 J346 T840 DPRZ LT80	620	620	68	5258	50,9	103	80+	4000	4,6
Quadro LED1x4550 D906 T840 DPRZ LT80	900	900	68	3765	36,4	103	80+	4000	6,6

PRODUCT	LENGTH, mm	WIDTH, mm	HEIGHT, mm	LUMINAIRE OUTPUT*, lm	SYSTEM POWER*, W	SYSTEM EFFICACY*, lm/W	CRI	CCT*, K	WEIGHT, kg
Quadro LED1x6200 D907 T840 DPRZ LT80	900	900	68	5124	52,5	98	80+	4000	6,6
Quadro LED1x8400 D908 T840 DPRZ LT80	900	900	68	6949	77,8	89	80+	4000	6,6
Quadro LED1x6100 D909 T840 DPRZ LT80	1180	1180	68	5020	48,5	103	80+	4000	8,8
Quadro LED1x8250 D910 T840 DPRZ LT80	1180	1180	68	6832	70,0	98	80+	4000	8,8
Quadro LED1x1200 D911 T840 DPRZ LT80	1180	1180	68	9265	103,7	89	80+	4000	8,8

*Tolerance range for optical and electrical data: ±10%. Values apply to an ambient temperature of 25°C. NORTHCLIFFE LIGHTING is constantly developing and improving its products. The right is reserved to change any product specifications without prior notification

AVAILABLE ACCESSORIES:



Product: Suspension MTG KIT SUSI
Description: Suspension wire set "I" type, 1.5m adjustable, 1pcs
**note - 4pcs MTG SUSI KIT for 1 luminaire required*



Product: CAP cable 3x0.75 2.0m clear
Description: Cable 3x0.75mm² for suspended luminaire up to 2.0 meters, transparent



Product: CAP4, light grey/ white/ black
Description: Square decorative metal cap for hiding cable inlet with suspension wire attachment point, push-in terminals 3x1x1.5mm², light grey/ white/ black



Product: CAP cable clip D6.3mm SET clear
Description: Cable and suspension wire clip set, 4pcs. For cable diameter up to 6,3mm and wire diameter 1mm

Product: CAP5, light grey/ white/ black
Description: Square decorative metal cap for hiding cable inlet with suspension wire attachment point, push-in terminals 5x1x1.5mm², light grey/ white/ black

OP

DPRZ LT80

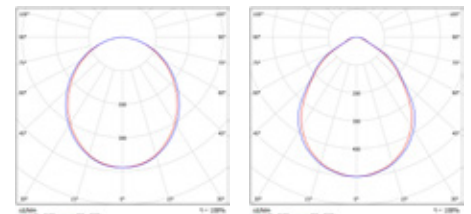

OPTIONS AVAILABLE ON REQUEST:

LED	REFLECTOR AND OPTICS	CONTROL GEAR	EMERGENCY	CONNECTION	OTHER	COLOUR
T830	OP	DALI	EM3	CBF3-2.0m clear	SR	RAL
T840	DPRZ LT80	BLT	EM3B	CBF3-3.0m clear		
			EM3A	CBF5-2.0m clear		
			EM3D	CBF5-3.0m clear		



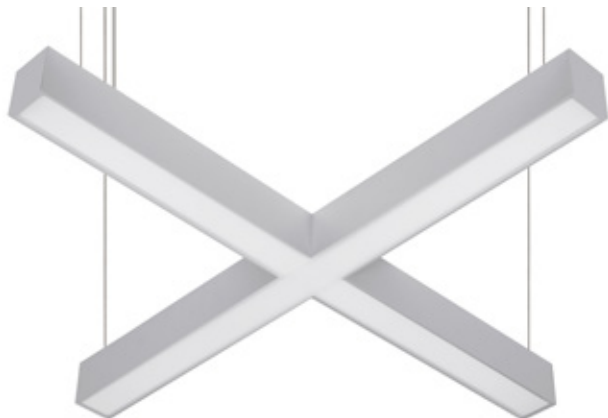

CROSS X LED

Aluminum Profile Luminaires



DESCRIPTION:	Surface mounted or suspended aluminium profile LED luminaire Light distribution type: direct Optical system: opal polycarbonate diffuser Housing: aluminium Colour: light grey, RAL9006S; white, RAL9003S; black, RAL9005S
GENERAL DATA:	Mains voltage: 220-240V, 0/50-60Hz LED lifetime, h: 50000/L80B10 SDCM: 3 Protection class IEC: I Ingress protection code: IP40 Mechanical impact resistance: IK05 Operating temperature range, °C: ta 0...+35
INSTALLATION:	On the ceiling or suspended (wire, cable and cap to be ordered separately). Push-in terminal, 3x2x2.5mm ²
ENVIRONMENT:	Indoor
APPLICATION:	Office, education, hotel, corridor, retail, public place

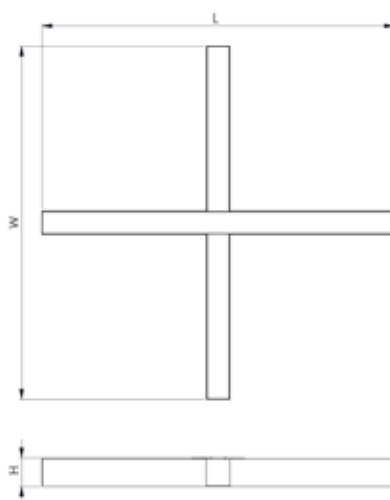

PRODUCT	LENGTH, mm	WIDTH, mm	HEIGHT, mm	LUMINAIRE OUTPUT*, lm	SYSTEM POWER*, W	SYSTEM EFFICACY*, lm/W	CRI	CCT*, K	WEIGHT, kg
Cross X LED1x2450 J356 T840 OP	858	858	68	2410	18,8	128	80+	4000	3,5
Cross X LED1x3300 J357 T840 OP	858	858	68	3285	26,4	124	80+	4000	3,5
Cross X LED1x4550 J358 T840 OP	858	858	68	4516	38,6	117	80+	4000	3,5
Cross X LED1x3250 J359 T840 OP	1138	1138	68	3214	24,8	130	80+	4000	4,6
Cross X LED1x4400 J360 T840 OP	1138	1138	68	4380	34,7	126	80+	4000	4,6
Cross X LED1x6050 J361 T840 OP	1138	1138	68	6021	50,9	118	80+	4000	4,6

*Tolerance range for optical and electrical data: ±10%. Values apply to an ambient temperature of 25°C. NORTHCLIFFE LIGHTING is constantly developing and improving its products. The right is reserved to change any product specifications without prior notification

AVAILABLE ACCESSORIES:



Product: Suspension MTG KIT SUSI
Description: Suspension wire set "I" type, 1.5m adjustable, 1pcs
**note - 4pcs MTG SUSI KIT for 1 luminaire required*
**note - SUS option is required*



Product: CAP4, light grey/ white/ black
Description: Square decorative metal cap for hiding cable inlet with suspension wire attachment point, push-in terminals 3x1x1.5mm², light grey/ white/ black

Product: CAP5, light grey/ white/ black
Description: Square decorative metal cap for hiding cable inlet with suspension wire attachment point, push-in terminals 5x1x1.5mm², light grey/ white/ black



Product: CAP cable 3x0.75 2.0m clear
Description: Cable 3x0.75mm² for suspended luminaire up to 2.0 meters, transparent



Product: CAP cable clip D6.3mm SET clear
Description: Cable and suspension wire clip set, 4pcs. For cable diameter up to 6,3mm and wire diameter 1mm

OPTIONS AVAILABLE ON REQUEST:

LED	REFLECTOR AND OPTICS	CONTROL GEAR	CONNECTION	OTHER	COLOUR
T830	OP	DALI	CBF3-2.0m clear	SUS	RAL
T840	DPRZ LT80		CBF3-3.0m clear		
			CBF5-2.0m clear		
			CBF5-3.0m clear		

OP

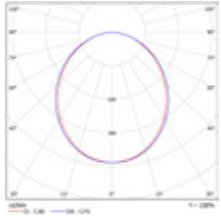

DPRZ LT80

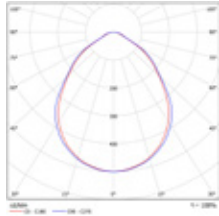

TRIANGLE LED

Aluminum Profile Luminaires



DESCRIPTION: Surface mounted or suspended aluminium profile LED luminaire
Light distribution type: direct
Optical system: opal polycarbonate diffuser
Housing: aluminium
Colour: light grey, RAL9006S; white, RAL9003S; black, RAL9005S

GENERAL DATA: Mains voltage: 220-240V, 0/50-60Hz
 LED lifetime, h: 50000/L80B10
 SDCM: 3
Protection class IEC: I
Ingress protection code: IP40
Mechanical impact resistance: IK05
Operating temperature range, °C: ta 0..+35

INSTALLATION: On the ceiling or suspended (wire, cable and cap to be ordered separately). Push-in terminal, 3x2x2.5mm²

ENVIRONMENT: Indoor

APPLICATION: Office, education, hotel, corridor, retail, public place

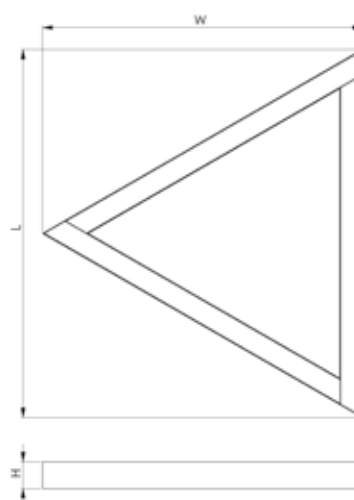

PRODUCT	LENGTH, mm	WIDTH, mm	HEIGHT, mm	LUMINAIRE OUTPUT*, lm	SYSTEM POWER*, W	SYSTEM EFFICACY*, lm/W	CRI	CCT*, K	WEIGHT, kg
Triangle LED1x3650 J386 T840 OP	945	819	68	3616	28,3	128	80+	4000	4,8
Triangle LED1x4950 J387 T840 OP	945	819	68	4927	39,9	123	80+	4000	4,8
Triangle LED1x7000 J388 T840 OP	945	819	68	6979	60,8	115	80+	4000	4,8
Triangle LED1x4850 J389 T840 OP	1225	1061	68	4821	37,3	129	80+	4000	6,3
Triangle LED1x6600 J390 T840 OP	1225	1061	68	6570	52,6	125	80+	4000	6,3
Triangle LED1x9350 J391 T840 OP	1225	1061	68	9305	80,2	116	80+	4000	6,3

*Tolerance range for optical and electrical data: ±10%. Values apply to an ambient temperature of 25°C. NORTHCLIFFE LIGHTING is constantly developing and improving its products. The right is reserved to change any product specifications without prior notification

AVAILABLE ACCESSORIES:



Product: Suspension MTG KIT SUSI
Description: Suspension wire set "I" type, 1.5m adjustable, 1pcs
**note - 3pcs MTG SUSI KIT for 1 luminaire required*
**note - SUS option is required*



Product: CAP cable 3x0.75 2.0m clear
Description: Cable 3x0.75mm² for suspended luminaire up to 2.0 meters, transparent



Product: CAP4, light grey/ white/ black
Description: Square decorative metal cap for hiding cable inlet with suspension wire attachment point, push-in terminals 3x1x1.5mm², light grey/ white/ black



Product: CAP5, light grey/ white/ black
Description: Square decorative metal cap for hiding cable inlet with suspension wire attachment point, push-in terminals 5x1x1.5mm², light grey/ white/ black

Product: CAP cable clip D6.3mm SET clear
Description: Cable and suspension wire clip set, 4pcs. For cable diameter up to 6,3mm and wire diameter 1mm

OPTIONS AVAILABLE ON REQUEST:

LED	REFLECTOR AND OPTICS	CONTROL GEAR	CONNECTION	OTHER	COLOUR
T830	OP	DALI	CBF3-2.0m clear	SUS	RAL
T840	DPRZ LT80		CBF3-3.0m clear		

OP

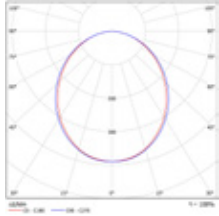

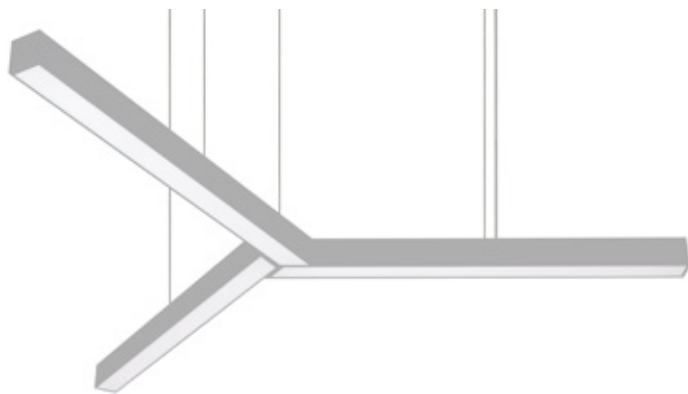

TRIO Y LED

Aluminum Profile Luminaires

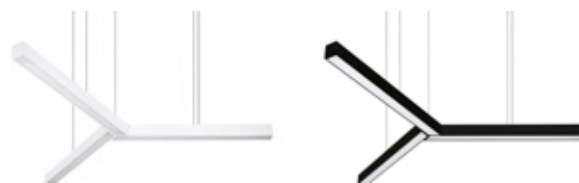

DESCRIPTION: Surface mounted or suspended aluminium profile LED luminaire
Light distribution type: direct
Optical system: opal polycarbonate diffuser
Housing: aluminium
Colour: light grey, RAL9006S; white, RAL9003S; black, RAL9005S

GENERAL DATA: **Mains voltage:** 220-240V, 0/50-60Hz
LED lifetime, h: 50000/L80B10
SDCM: 3
Protection class IEC: I
Ingress protection code: IP40
Mechanical impact resistance: IK05
Operating temperature range, °C: ta 0...+35

INSTALLATION: On the ceiling or suspended, system of three parts (ordered separately) designed for installation into "Y" shape (join element, wire, cable and cap to be ordered separately). Push-in terminal, 3x2x2.5mm²

ENVIRONMENT: Indoor

APPLICATION: Office, education, hotel, corridor, retail, public place

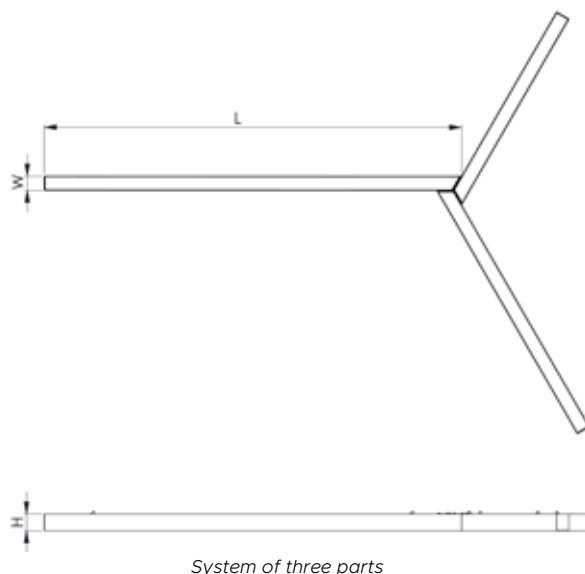

PRODUCT	LENGTH, mm	WIDTH, mm	HEIGHT, mm	LUMINAIRE OUTPUT*, lm	SYSTEM POWER*, W	SYSTEM EFFICACY*, lm/W	CRI	CCT*, K	WEIGHT, kg
Trio Y LED1x1250 J362 T840 OP LO1 875mm	875	58	68	1206	9,5	127	80+	4000	1,8
Trio Y LED1x1650 J363 T840 OP LO2 875mm	875	58	68	1642	14,0	117	80+	4000	1,8
Trio Y LED1x2300 J364 T840 OP LO3 875mm	875	58	68	2258	20,7	109	80+	4000	1,8
Trio Y LED1x1650 J365 T840 OP LO1 1155mm	1155	58	68	1607	12,6	128	80+	4000	2,3
Trio Y LED1x2200 J366 T840 OP LO2 1155mm	1155	58	68	2190	18,1	121	80+	4000	2,3
Trio Y LED1x3050 J367 T840 OP LO3 1155mm	1155	58	68	3010	26,4	114	80+	4000	2,3
Trio Y LED1x2050 J368 T840 OP LO1 1435mm	1435	58	68	2009	16,3	123	80+	4000	2,6
Trio Y LED1x2750 J369 T840 OP LO2 1435mm	1435	58	68	2737	22,7	121	80+	4000	2,6
Trio Y LED1x3800 J370 T840 OP LO3 1435mm	1435	58	68	3763	32,5	116	80+	4000	2,6
Trio Y LED1x2450 J371 T840 OP LO1 1715mm	1715	58	68	2410	19,1	126	80+	4000	3,1
Trio Y LED1x3300 J372 T840 OP LO2 1715mm	1715	58	68	3285	27,0	122	80+	4000	3,1
Trio Y LED1x4550 J373 T840 OP LO3 1715mm	1715	58	68	4516	38,6	117	80+	4000	3,1
Trio Y LED1x2850 J374 T840 OP LO1 1995mm	1995	58	68	2812	22,2	127	80+	4000	3,4
Trio Y LED1x3850 J375 T840 OP LO2 1995mm	1995	58	68	3832	31,0	124	80+	4000	3,4
Trio Y LED1x5300 J376 T840 OP LO3 1995mm	1995	58	68	5268	44,6	118	80+	4000	3,4
Trio Y LED1x3250 J377 T840 OP LO1 2275mm	2275	58	68	3214	25,1	128	80+	4000	4,0
Trio Y LED1x4400 J378 T840 OP LO2 2275mm	2275	58	68	4380	35,5	123	80+	4000	4,0
Trio Y LED1x6050 J379 T840 OP LO3 2275mm	2275	58	68	6021	50,9	118	80+	4000	4,0

PRODUCT	LENGTH, mm	WIDTH, mm	HEIGHT, mm	LUMINAIRE OUTPUT*, lm	SYSTEM POWER*, W	SYSTEM EFFICACY*, lm/W	CRI	CCT*, K	WEIGHT, kg
Trio Y LED1x3650 J380 T840 OP LO1 2555mm	2555	58	68	3616	27,6	131	80+	4000	4,6
Trio Y LED1x4950 J381 T840 OP LO2 2555mm	2555	58	68	4927	39,9	123	80+	4000	4,6
Trio Y LED1x6800 J382 T840 OP LO3 2555mm	2555	58	68	6773	57,3	118	80+	4000	4,6
Trio Y LED1x4250 J383 T840 OP LO1 2975mm	2975	58	68	4219	31,9	132	80+	4000	5,0
Trio Y LED1x5750 J384 T840 OP LO2 2975mm	2975	58	68	5748	46,0	125	80+	4000	5,0
Trio Y LED1x7950 J385 T840 OP LO3 2975mm	2975	58	68	7902	66,1	120	80+	4000	5,0

System of three parts (ordered as an individual luminaires)

*Tolerance range for optical and electrical data: ±10%. Values apply to an ambient temperature of 25°C. NORTHCLIFFE LIGHTING is constantly developing and improving its products. The right is reserved to change any product specifications without prior notification

AVAILABLE ACCESSORIES:



Product: Suspension MTG KIT SUSI
Description: Suspension wire set "I" type, 1.5m adjustable, 1pcs
**note - 2pcs MTG SUSI KIT for length up to 2000mm, 3pcs MTG SUSI KIT for lengths 2000 - 3000mm*
**note - SUS option is required*



Product: CAP cable 3x0.75 2.0m clear
Description: Cable 3x0.75mm² for suspended luminaire up to 2.0 meters, transparent



Product: CAP4, light grey/ white/ black
Description: Square decorative metal cap for hiding cable inlet with suspension wire attachment point, push-in terminals 3x1x1.5mm², light grey/ white/ black



Product: CAP cable clip D6.3mm SET clear
Description: Cable and suspension wire clip set, 4pcs. For cable diameter up to 6,3mm and wire diameter 1mm

Product: CAP5, light grey/ white/ black
Description: Square decorative metal cap for hiding cable inlet with suspension wire attachment point, push-in terminals 5x1x1.5mm², light grey/ white/ black



Product: Trio Y join kit
Description: Join element for stabilizing three parts when suspended installation is used.

OPTIONS AVAILABLE ON REQUEST:

LED	REFLECTOR AND OPTICS	CONTROL GEAR	CONNECTION	OTHER	COLOUR
T830	OP	DALI	CBF3-2.0m clear	SUS	RAL
T840	DPRZ LT80		CBF3-3.0m clear		

OP

DPRZ LT80

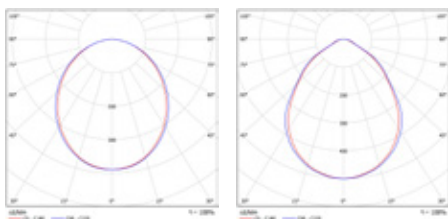

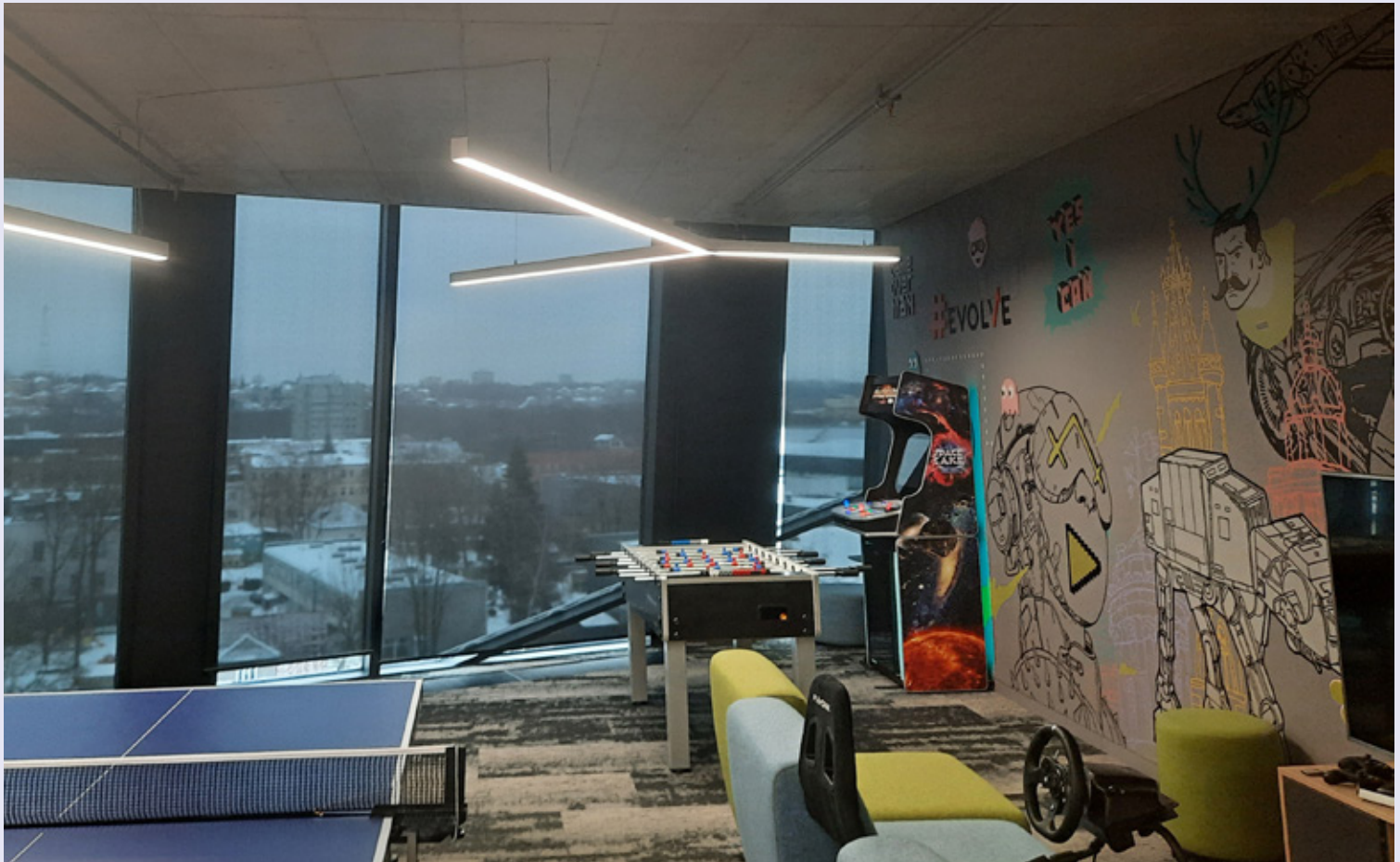

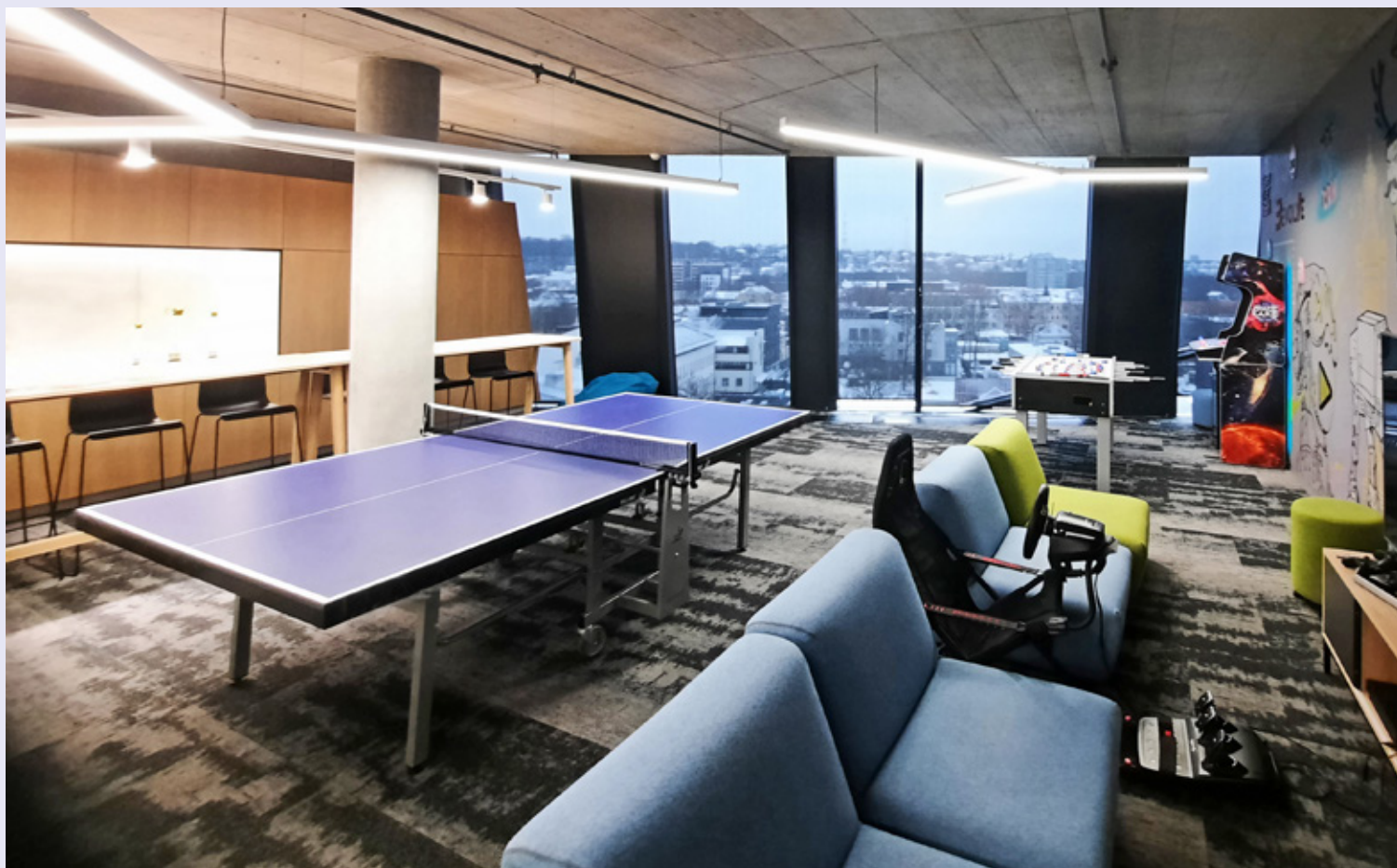

CROSS V LED

Aluminum Profile Luminaires

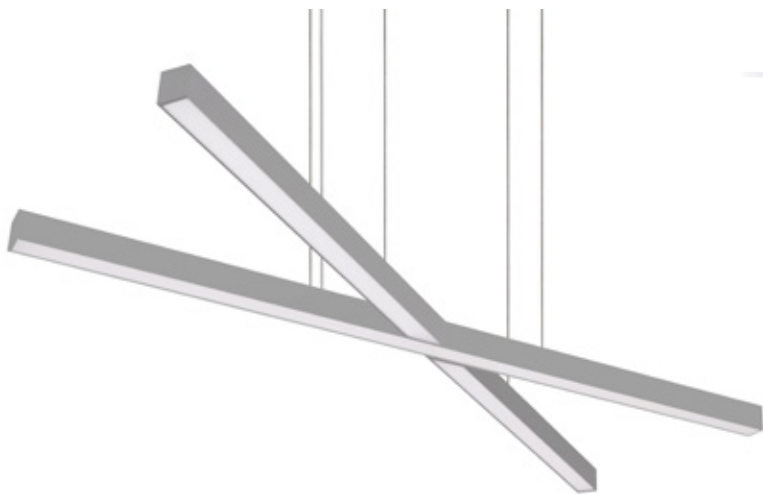

DESCRIPTION: **Suspended decorative aluminium profile LED luminaire**
Light distribution type: direct
Optical system: opal polycarbonate diffuser
Housing: aluminium
Colour: light grey, RAL9006S; white, RAL9003S; black, RAL9005S

GENERAL DATA: **Mains voltage:** 220-240V, 0/50-60Hz
LED lifetime, h: 50000/L80B10
SDCM: 3
Protection class IEC: I
Ingress protection code: IP40
Mechanical impact resistance: IK05
Operating temperature range, °C: ta 0...+35

INSTALLATION: Suspended (wire and cap to be ordered separately). Cable 2.0m, 3x0.75mm², transparent

ENVIRONMENT: Indoor

APPLICATION: Office, education, hotel, retail, public place

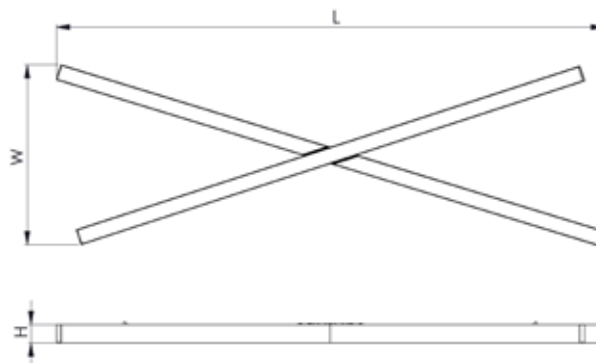

PRODUCT	LENGTH, mm	WIDTH, mm	HEIGHT, mm	LUMINAIRE OUTPUT*, lm	SYSTEM POWER*, W	SYSTEM EFFICACY*, lm/W	CRI	CCT*, K	WEIGHT, kg
Cross V LED1x5650 J410 T840 OP	1952	676	74	5625	43,0	131	80+	4000	6,5
Cross V LED1x7700 J411 T840 OP	1952	676	74	7665	62,1	123	80+	4000	6,5
Cross V LED1x10550 J412 T840 OP	1952	676	74	10535	88,2	119	80+	4000	6,5

*Tolerance range for optical and electrical data: ±10%. Values apply to an ambient temperature of 25°C. NORTHCLIFFE LIGHTING is constantly developing and improving its products. The right is reserved to change any product specifications without prior notification

AVAILABLE ACCESSORIES:



Product: Suspension MTG KIT SUSI
Description: Suspension wire set "I" type, 1.5m adjustable, 1pcs
**note - 4pcs MTG SUSI KIT for 1 luminaire required*



Product: CAP cable 3x0.75 2.0m clear
Description: Cable 3x0.75mm² for suspended luminaire up to 2.0 meters, transparent



Product: CAP4, light grey/ white/ black
Description: Square decorative metal cap for hiding cable inlet with suspension wire attachment point, push-in terminals 3x1x1.5mm², white/ light grey/ black



Product: CAP5, light grey/ white/ black
Description: Square decorative metal cap for hiding cable inlet with suspension wire attachment point, push-in terminals 5x1x1.5mm², light grey/ white/ black

Product: CAP cable clip D6.3mm SET clear
Description: Cable and suspension wire clip set, 4pcs. For cable diameter up to 6,3mm and wire diameter 1mm

OPTIONS AVAILABLE ON REQUEST:

LED	REFLECTOR AND OPTICS	CONTROL GEAR	CONNECTION	COLOUR
T830	OP	DALI	CBF3-2.0m clear	RAL
T840	DPRZ LT80		CBF3-3.0m clear	
			CBF5-2.0m clear	
			CBF5-3.0m clear	

OP

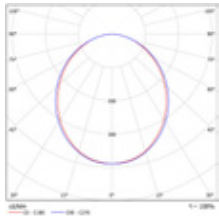

DPRZ LT80

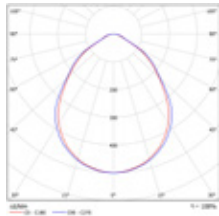

NORTHCLIFFE
making life brighter

FREESTANDING LUMINAIRES

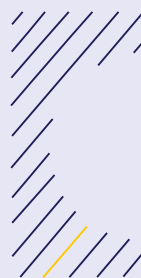

Fornax LED

Freestanding Luminaires

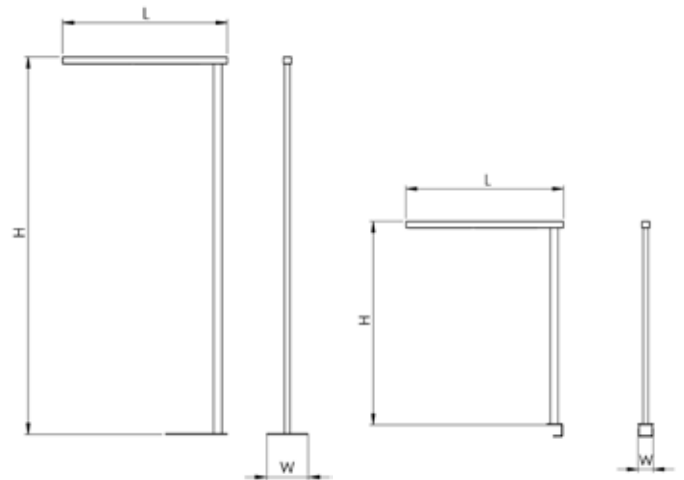
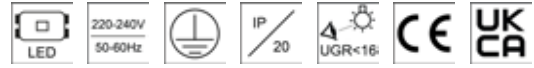

Fornax F LED

Fornax T LED

DESCRIPTION: Freestanding floor or table clamp-on LED luminaire

Light distribution type: direct/indirect
Optical system: double parabolic reflector with lenses, UGR<16
Housing: aluminium
Colour: white, RAL9016; light grey, RAL9006; black, RAL9005

GENERAL DATA: **Mains voltage:** 220-240V, 50-60Hz
LED lifetime, h: 50000/L80B20
SDCM: 3 (Fornax T LED: 5)
Protection class IEC: I
Ingress protection code: IP20
Mechanical impact resistance: IK02
Operating temperature range, °C: -10..+40

INSTALLATION: Free-standing or clamp-on. Cable 2.8m with plug, Schuko type

ENVIRONMENT: Indoor

APPLICATION: Office, education

PRODUCT	LENGTH, mm	WIDTH, mm	HEIGHT, mm	LUMINAIRE OUTPUT*, lm	SYSTEM POWER*, W	SYSTEM EFFICACY*, lm/W	CRI	CCT*, K	WEIGHT, kg
Fornax F LED1x10500 J869 T840 L1A15 DIM PIR RAL9016 Schuko-2.8m	1060	240	2050	10000	80,0	125	80	4000	12,5
Fornax T LED1x10500 J870 T840 L1A15 DIM PIR RAL9016 Schuko-2.8m	1060	70	1300	10000	80,0	125	80	4000	5,1

*Tolerance range for optical and electrical data: ±10%. Values apply to an ambient temperature of 25°C. NORTHCLIFFE LIGHTING is constantly developing and improving its products. The right is reserved to change any product specifications without prior notification

OPTIONS AVAILABLE ON REQUEST:

LED
T830
T840

STANDARD

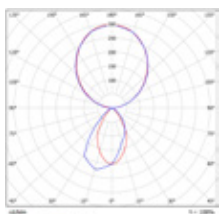

Rod LED

Freestanding Luminaires



DESCRIPTION: **Free-standing LED luminaire**
Light distribution type: direct
Optical system: opal polycarbonate diffuser
Housing: aluminium
Colour: white, RAL9016; light grey, RAL9006; black, RAL9005

GENERAL DATA: **Mains voltage:** 220-240V, 50-60Hz
LED lifetime, h: 50000/L80B50
SDCM: 3
Protection class IEC: II
Ingress protection code: IP20
Mechanical impact resistance: IK02
Operating temperature range, °C: -20...+45

INSTALLATION: Free-standing. Cable 1.7m with plug, Europlug type

ENVIRONMENT: Indoor

APPLICATION: Office, education

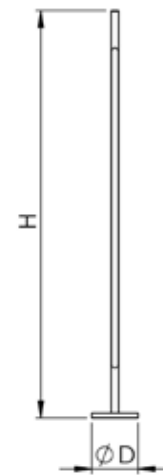

PRODUCT	DIAMETER, mm	HEIGHT, mm	LUMINAIRE OUTPUT*, lm	SYSTEM POWER*, W	SYSTEM EFFICACY*, lm/W	CRI	CCT*, K	WEIGHT, kg
Rod LED1x1400 J871 T830-57 TW RAL9016 Europlug-1.7m	182	1600	1400	15,0	93	80	3000-5700	2,8

*Tolerance range for optical and electrical data: ±10%. Values apply to an ambient temperature of 25°C. NORTHCLIFFE LIGHTING is constantly developing and improving its products. The right is reserved to change any product specifications without prior notification

STANDARD

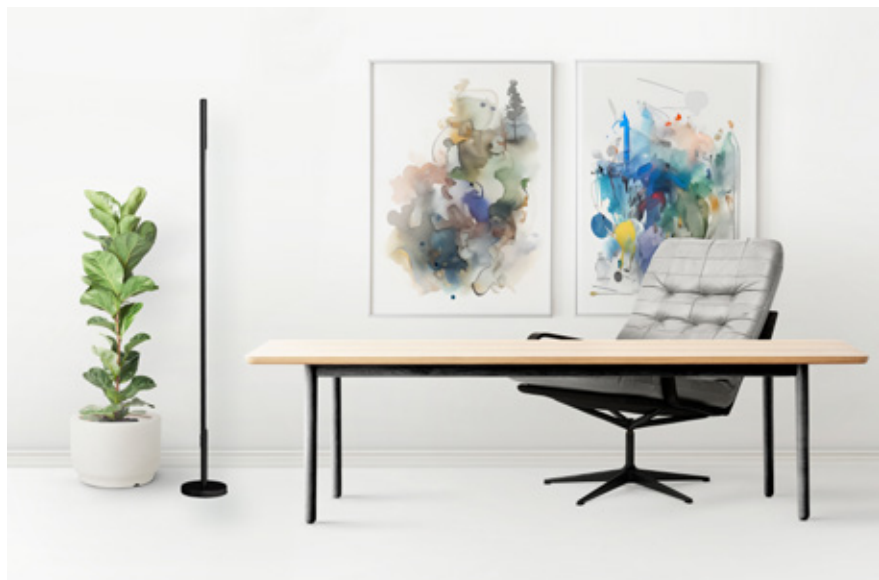
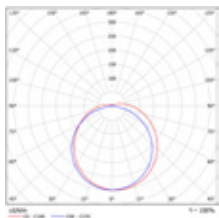

NORTHCLIFFE
making life brighter

ACOUSTIC LUMINAIRES

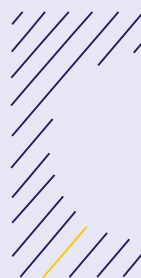

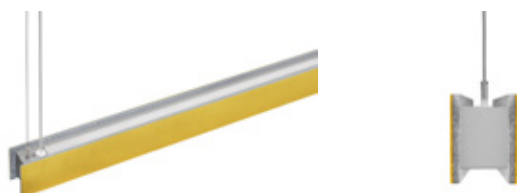

HAUD LED

Acoustic luminaires



DESCRIPTION: **Acoustic suspended decorative LED luminaire**
Light distribution type: direct/indirect
Optical system: opal polycarbonate diffuser
Housing: aluminium
Colour: made to the customer's specification

GENERAL DATA: **Mains voltage:** 220-240V, 0/50-60Hz
LED lifetime, h: 50000/L80B10
SDCM: 3
Protection class IEC: I
Ingress protection code: IP40
Mechanical impact resistance: IK05
Operating temperature range, °C: ta 0...+35

INSTALLATION: Suspended (wire and cap to be ordered separately). Cable 2.0m, 3x0.75mm², transparent

ENVIRONMENT: Indoor

APPLICATION: Office, education, hotel, retail, public place



PRODUCT	LENGTH, mm	WIDTH, mm	HEIGHT, mm	LUMINAIRE OUTPUT*, lm	SYSTEM POWER*, W	SYSTEM EFFICACY*, lm/W	CRI	CCT*, K	WEIGHT, kg
Haud LED1x1650/1050 J413 T840 OP M... (felt colour code)	1159	50	99	2644	21,0	125	80+	4000	3,9
Haud LED1x2200/1450 J414 T840 OP M... (felt colour code)	1159	50	99	3604	29,4	122	80+	4000	3,9
Haud LED1x3050/1950 J415 T840 OP M... (felt colour code)	1159	50	99	4953	43,1	114	80+	4000	3,9
Haud LED1x2050/1400 J416 T840 OP M... (felt colour code)	1439	50	99	3392	26,4	128	80+	4000	4,8
Haud LED1x2750/1900 J417 T840 OP M... (felt colour code)	1439	50	99	4622	37,8	122	80+	4000	4,8
Haud LED1x3800/2600 J418 T840 OP M... (felt colour code)	1439	50	99	6354	54,9	116	80+	4000	4,8

*Tolerance range for optical and electrical data: ±10%. Values apply to an ambient temperature of 25°C. NORTHCLIFFE LIGHTING is constantly developing and improving its products. The right is reserved to change any product specifications without prior notification

AVAILABLE ACCESSORIES:



Product: CAP4, light grey/ white/ black
Description: Square decorative metal cap for hiding cable inlet with suspension wire attachment point, push-in terminals 3x1x1.5mm², light grey/ white/ black

Product: CAP5, light grey/ white/ black
Description: Square decorative metal cap for hiding cable inlet with suspension wire attachment point, push-in terminals 5x1x1.5mm², light grey/ white/ black



Product: Suspension MTG KIT SUSI
Description: Suspension wire set "I" type, 1.5m adjustable, 1pcs
**note - at least 2pcs MTG KIT SUSI for one fitting required. For exact quantity please refer to installation manual*



Product: CAP cable clip D6.3mm SET clear
Description: Cable and suspension wire clip set, 4pcs. For cable diameter up to 6,3mm and wire diameter 1mm

OPTIONS AVAILABLE ON REQUEST:

LED	REFLECTOR AND OPTICS	CONTROL GEAR	COLOUR
T830	OP	DALI	RAL
T840	DPRZ LT80	DALIsep	M... (felt colour code) ²
		PULL ¹	
		PULLDIM ¹	
		Lsep	

1 For PULL and PULLDIM options luminaire housing is 50mm longer and switch is positioned at the end of luminaire
 2 List of material colour is found on page 238

OP

DPRZ LT80

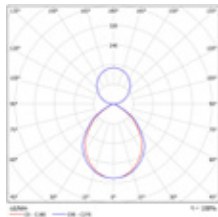
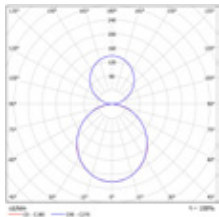

FORMA A LED

Acoustic luminaires

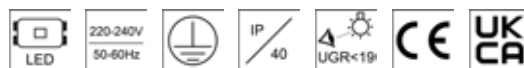

DESCRIPTION:	<p>A decorative acoustic ring-shaped LED luminaire Light distribution type: direct Optical system: opal PMMA diffuser, UV stabilized Housing: steel Colour: white, RAL9003S; light grey, RAL9006S; black, RAL9005S</p>
GENERAL DATA:	<p>Mains voltage: 220-240V, 0/50-60Hz LED lifetime, h: 50000/L80B10 SDCM: 3 Protection class IEC: I Ingress protection code: IP40 Mechanical impact resistance: IK02 Operating temperature range, °C: ta 0...+35</p>
INSTALLATION:	<p>On the ceiling or suspended (accessories to be ordered separately). Push-in terminal, 3x2x2.5mm²</p>
ENVIRONMENT:	Indoor
APPLICATION:	Office, education, retail, public place

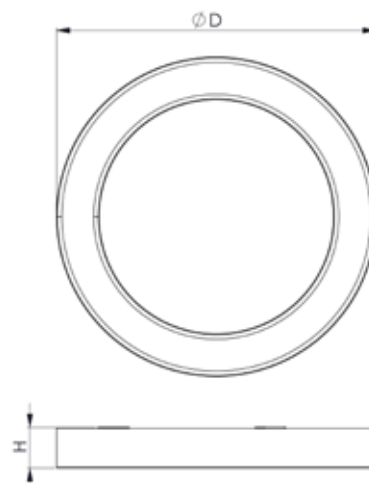

PRODUCT	DIAMETER, mm	HEIGHT, mm	LUMINAIRE OUTPUT*, lm	SYSTEM POWER*, W	SYSTEM EFFICACY*, lm/W	CRI	CCT*, K	WEIGHT, kg
Forma A LED1x2050 J146 T840 OP M... (felt colour code)	600	80	2014	16,9	119	80+	4000	5,7
Forma A LED1x2750 J147 T840 OP M... (felt colour code)	600	80	2744	23,6	116	80+	4000	5,7
Forma A LED1x3800 J148 T840 OP M... (felt colour code)	600	80	3772	34,6	109	80+	4000	5,7
Forma A LED1x3300 J149 T840 OP M... (felt colour code)	900	80	3295	26,4	125	80+	4000	10,0
Forma A LED1x4500 J150 T840 OP M... (felt colour code)	900	80	4491	37,7	119	80+	4000	10,0
Forma A LED1x6200 J151 T840 OP M... (felt colour code)	900	80	6173	54,9	112	80+	4000	10,0
Forma A LED1x4400 J152 T840 OP M... (felt colour code)	1200	80	4394	34,8	126	80+	4000	14,9
Forma A LED1x6000 J153 T840 OP M... (felt colour code)	1200	80	5987	49,8	120	80+	4000	14,9
Forma A LED1x8250 J154 T840 OP M... (felt colour code)	1200	80	8231	72,4	114	80+	4000	14,9

*Tolerance range for optical and electrical data: ±10%. Values apply to an ambient temperature of 25°C. NORTHCLIFFE LIGHTING is constantly developing and improving its products. The right is reserved to change any product specifications without prior notification

AVAILABLE ACCESSORIES:



Product: Suspension MTG KIT SUSI
Description: Suspension wire set "I" type, 1.5m adjustable, 1pcs
**note - at least 3pcs MTG KIT SUSI for one fitting required. For exact quantity please refer to installation manual*



Product: CAP4, light grey/ white/ black
Description: Square decorative metal cap for hiding cable inlet with suspension wire attachment point, push-in terminals 3x1x1.5mm², light grey/ white/ black

Product: CAP5, light grey/ white/ black
Description: Square decorative metal cap for hiding cable inlet with suspension wire attachment point, push-in terminals 5x1x1.5mm², light grey/ white/ black



Product: CAP cable 3x0.75 2.0m clear
Description: Cable 3x0.75mm² for suspended luminaire up to 2.0 meters, transparent



Product: CAP cable clip D6.3mm SET clear
Description: Cable and suspension wire clip set, 4pcs. For cable diameter up to 6,3mm and wire diameter 1mm



Product: Suspension MTG KIT Bootes C LED / Lodos L LED, white/ light grey/ black
Description: Suspension wire set with cap 3x"I" type, 1.5m adjustable, 1pcs
**note - for compatibility with exact product please refer to installation manual*

OPTIONS AVAILABLE ON REQUEST:

LED	REFLECTOR AND OPTICS	CONTROL GEAR	CONNECTION	COLOUR
T830	OP	DALI	CBF3-2.0m clear	RAL
T840	DPRZ LT80	BLT	CBF3-3.0m clear	M... (felt colour code) ¹
		COR	CBF5-2.0m clear	
		COR1min	CBF5-3.0m clear	
		COR30min		

¹ List of material colour is found on page 238

OP

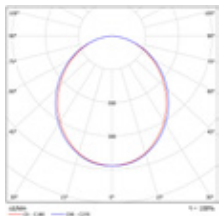

DPRZ LT80

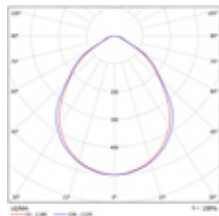



FORMA G LED

Acoustic luminaires



- DESCRIPTION:** **A decorative acoustic ring-shaped LED luminaire**
Light distribution type: direct
Optical system: opal PMMA diffuser, UV stabilized
Housing: steel
Colour: white, RAL9003S; light grey, RAL9006S; black, RAL9005S
-
- GENERAL DATA:** **Mains voltage:** 220-240V, 0/50-60Hz
LED lifetime, h: 50000/L80B10
SDCM: 3
Protection class IEC: I
Ingress protection code: IP40
Mechanical impact resistance: IK02
Operating temperature range, °C: ta 0...+35
-
- INSTALLATION:** On the ceiling or suspended (accessories to be ordered separately). Push-in terminal, 3x2x2.5mm²
-
- ENVIRONMENT:** Indoor
-
- APPLICATION:** Office, education, retail, public place



PRODUCT	DIAMETER, mm	HEIGHT, mm	LUMINAIRE OUTPUT*, lm	SYSTEM POWER*, W	SYSTEM EFFICACY*, lm/W	CRI	CCT*, K	WEIGHT, kg
Forma G LED1x2050 J155 T840 OP	600	80	2014	16,9	119	80+	4000	6,4
Forma G LED1x2750 J156 T840 OP	600	80	2744	23,6	116	80+	4000	6,4
Forma G LED1x3800 J157 T840 OP	600	80	3772	34,6	109	80+	4000	6,4
Forma G LED1x3300 J158 T840 OP	900	80	3295	26,4	125	80+	4000	12,0
Forma G LED1x4500 J159 T840 OP	900	80	4491	37,7	119	80+	4000	12,0
Forma G LED1x6200 J160 T840 OP	900	80	6173	54,9	112	80+	4000	12,0
Forma G LED1x4400 J161 T840 OP	1200	80	4394	34,8	126	80+	4000	18,8
Forma G LED1x6000 J162 T840 OP	1200	80	5987	49,8	120	80+	4000	18,8
Forma G LED1x8250 J706 T840 OP	1200	80	8231	72,4	114	80+	4000	18,8

*Tolerance range for optical and electrical data: ±10%. Values apply to an ambient temperature of 25°C. NORTHCLIFFE LIGHTING is constantly developing and improving its products. The right is reserved to change any product specifications without prior notification

AVAILABLE ACCESSORIES:



Product: Suspension MTG KIT SUSI
Description: Suspension wire set "I" type, 1.5m adjustable, 1pcs
**note - at least 3pcs MTG KIT SUSI for one fitting required. For exact quantity please refer to installation manual*



Product: CAP cable 3x0.75 2.0m clear
Description: Cable 3x0.75mm² for suspended luminaire up to 2.0 meters, transparent



Product: Suspension MTG KIT Bootes C LED / Lodos L LED, white/ light grey/ black
Description: Suspension wire set with cap 3x"1" type, 1.5m adjustable, 1pcs
**note - for compatibility with exact product please refer to installation manual*



Product: CAP cable clip D6.3mm SET clear
Description: Cable and suspension wire clip set, 4pcs. For cable diameter up to 6,3mm and wire diameter 1mm



Product: CAP4, light grey/ white/ black
Description: Square decorative metal cap for hiding cable inlet with suspension wire attachment point, push-in terminals 3x1x1.5mm², light grey/ white/ black

Product: CAP5, light grey/ white/ black
Description: Square decorative metal cap for hiding cable inlet with suspension wire attachment point, push-in terminals 5x1x1.5mm², light grey/ white/ black

OPTIONS AVAILABLE ON REQUEST:

LED	REFLECTOR AND OPTICS	CONTROL GEAR	CONNECTION	COLOUR
T830	OP	DALI	CBF3-2.0m clear	RAL
T840	DPRZ LT80	BLT	CBF3-3.0m clear	
		COR	CBF5-2.0m clear	
		COR1min	CBF5-3.0m clear	
		COR30min		

OP

DPRZ LT80

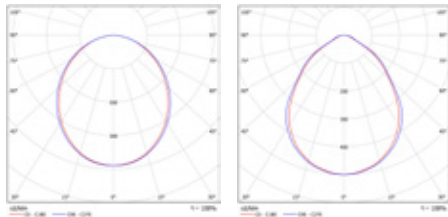



QUADRO A LED

Acoustic luminaires

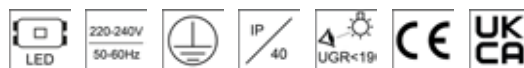

DESCRIPTION: **Suspended acoustic LED luminaire**
Light distribution type: direct
Optical system: opal polycarbonate diffuser
Housing: aluminium
Colour: white, RAL9003S; light grey, RAL9006S; black, RAL9005S

GENERAL DATA: **Mains voltage:** 220-240V, 0/50-60Hz
LED lifetime, h: 50000/L80B10
SDCM: 3
Protection class IEC: I
Ingress protection code: IP40
Mechanical impact resistance: IK05
Operating temperature range, °C: ta 15...+35

INSTALLATION: Suspended (wire and cap to be ordered separately). Cable 2.0m, 3x0.75mm², transparent

ENVIRONMENT: Indoor

APPLICATION: Office, education, hotel, retail, public place

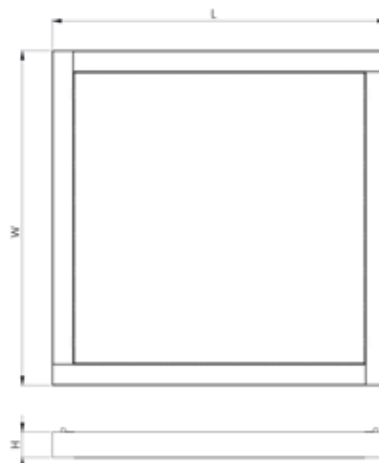

PRODUCT	LENGTH, mm	WIDTH, mm	HEIGHT, mm	LUMINAIRE OUTPUT*, lm	SYSTEM POWER*, W	SYSTEM EFFICACY*, lm/W	CRI	CCT*, K	WEIGHT, kg
Quadro A LED1x3250 J347 T840 OP M... (felt colour code)	620	620	68	3214	24,8	130	80+	4000	5,6
Quadro A LED1x4400 J348 T840 OP M... (felt colour code)	620	620	68	4380	34,7	126	80+	4000	5,6
Quadro A LED1x6050 J349 T840 OP M... (felt colour code)	620	620	68	6021	50,9	118	80+	4000	5,6
Quadro A LED1x4750 J350 T840 OP M... (felt colour code)	900	900	68	4721	36,4	130	80+	4000	9,1
Quadro A LED1x6450 J351 T840 OP M... (felt colour code)	900	900	68	6425	52,5	122	80+	4000	9,1
Quadro A LED1x8750 J352 T840 OP M... (felt colour code)	900	900	68	8713	77,8	112	80+	4000	9,1
Quadro A LED1x6300 J353 T840 OP M... (felt colour code)	1180	1180	68	6295	48,5	130	80+	4000	13,4
Quadro A LED1x8600 J354 T840 OP M... (felt colour code)	1180	1180	68	8567	70,0	122	80+	4000	13,4
Quadro A LED1x11650 J355 T840 OP M... (felt colour code)	1180	1180	68	11618	103,7	112	80+	4000	13,4

*Tolerance range for optical and electrical data: ±10%. Values apply to an ambient temperature of 25°C. NORTHCLIFFE LIGHTING is constantly developing and improving its products. The right is reserved to change any product specifications without prior notification

AVAILABLE ACCESSORIES:



Product: Suspension MTG KIT SUSI
Description: Suspension wire set "I" type, 1.5m adjustable, 1pcs
**note - 4pcs MTG SUSI KIT for 1 luminaire required*



Product: CAP cable 3x0.75 2.0m clear
Description: Cable 3x0.75mm² for suspended luminaire up to 2.0 meters, transparent



Product: CAP4, light grey/ white/ black
Description: Square decorative metal cap for hiding cable inlet with suspension wire attachment point, push-in terminals 3x1x1.5mm², light grey/ white/ black



Product: CAP cable clip D6.3mm SET clear
Description: Cable and suspension wire clip set, 4pcs. For cable diameter up to 6,3mm and wire diameter 1mm

Product: CAP5, light grey/ white/ black
Description: Square decorative metal cap for hiding cable inlet with suspension wire attachment point, push-in terminals 5x1x1.5mm², light grey/ white/ black

OPTIONS AVAILABLE ON REQUEST:

LED	REFLECTOR AND OPTICS	CONTROL GEAR	CONNECTION	OTHER	COLOUR
T830	OP	DALI	CBF3-2.0m clear	SR	RAL
T840	DPRZ LT80		CBF3-3.0m clear		M... (felt colour code) ¹
			CBF5-2.0m clear		
			CBF5-3.0m clear		

¹ List of material colour is found on page 238

OP

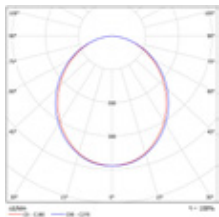

DPRZ LT80

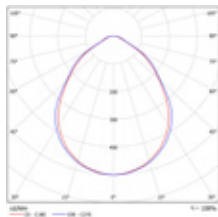

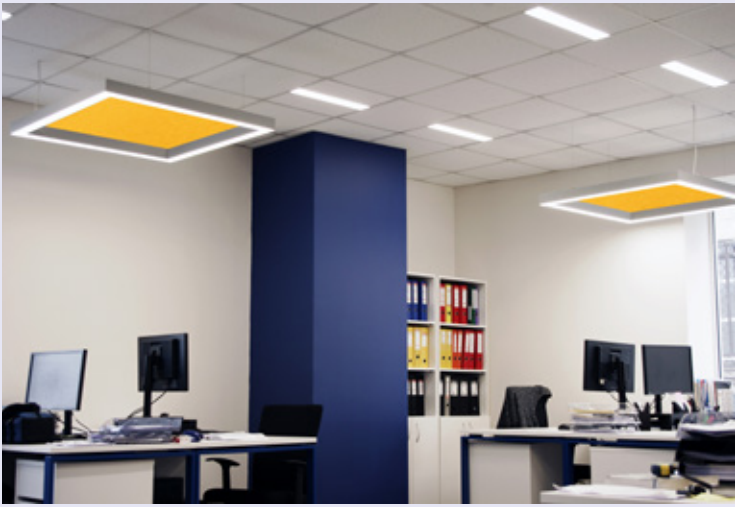

QUADRO G LED

Acoustic luminaires

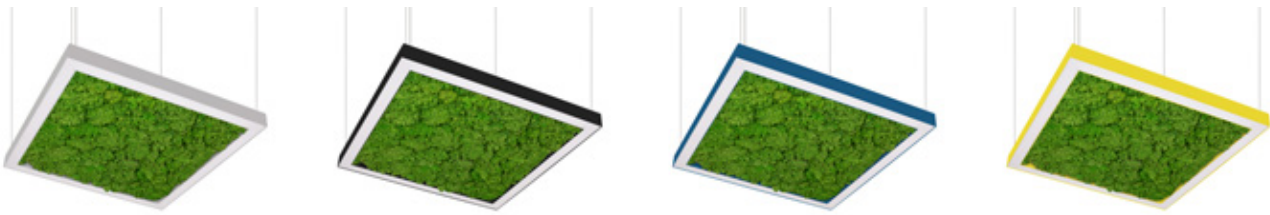

- DESCRIPTION:** **Suspended acoustic LED luminaire**
Light distribution type: direct
Optical system: opal polycarbonate diffuser
Housing: aluminium
Colour: white, RAL9003S; light grey, RAL9006S; black, RAL9005S
-
- GENERAL DATA:** **Mains voltage:** 220-240V, 0/50-60Hz
LED lifetime, h: 50000/L80B10
SDCM: 3
Protection class IEC: I
Ingress protection code: IP40
Mechanical impact resistance: IK05
Operating temperature range, °C: ta 15...+35
-
- INSTALLATION:** Suspended (wire and cap to be ordered separately). Cable 2.0m, 3x0.75mm², transparent
-
- ENVIRONMENT:** Indoor
-
- APPLICATION:** Office, education, hotel, retail, public place

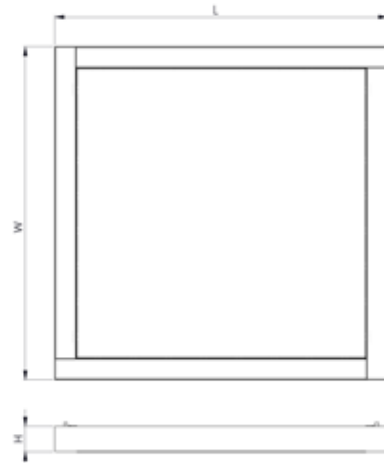

PRODUCT	LENGTH, mm	WIDTH, mm	HEIGHT, mm	LUMINAIRE OUTPUT*, lm	SYSTEM POWER*, W	SYSTEM EFFICACY*, lm/W	CRI	CCT*, K	WEIGHT, kg
Quadro G LED1x3250 J466 T840 OP	620	620	68	3214	24,8	130	80+	4000	5,6
Quadro G LED1x4400 J467 T840 OP	620	620	68	4380	34,7	126	80+	4000	5,6
Quadro G LED1x6050 J468 T840 OP	620	620	68	6021	50,9	118	80+	4000	5,6
Quadro G LED1x4750 J469 T840 OP	900	900	68	4721	36,4	130	80+	4000	12,4
Quadro G LED1x6450 J470 T840 OP	900	900	68	6425	52,5	122	80+	4000	12,4
Quadro G LED1x8750 J471 T840 OP	900	900	68	8713	77,8	112	80+	4000	12,4
Quadro G LED1x6300 J472 T840 OP	1180	1180	68	6295	48,5	130	80+	4000	13,4
Quadro G LED1x8600 J473 T840 OP	1180	1180	68	8567	70,0	122	80+	4000	13,4
Quadro G LED1x11650 J474 T840 OP	1180	1180	68	11618	103,7	112	80+	4000	13,4

*Tolerance range for optical and electrical data: ±10%. Values apply to an ambient temperature of 25°C. NORTHCLIFFE LIGHTING is constantly developing and improving its products. The right is reserved to change any product specifications without prior notification

AVAILABLE ACCESSORIES:



Product: Suspension MTG KIT SUSI
Description: Suspension wire set "I" type, 1.5m adjustable, 1pcs
**note - 4pcs MTG SUSI KIT for 1 luminaire required*



Product: CAP cable 3x0.75 2.0m clear
Description: Cable 3x0.75mm² for suspended luminaire up to 2.0 meters, transparent



Product: CAP4, light grey/ white/ black
Description: Square decorative metal cap for hiding cable inlet with suspension wire attachment point, push-in terminals 3x1x1.5mm², light grey/ white/ black



Product: CAP cable clip D6.3mm SET clear
Description: Cable and suspension wire clip set, 4pcs. For cable diameter up to 6,3mm and wire diameter 1mm

Product: CAP5, light grey/ white/ black
Description: Square decorative metal cap for hiding cable inlet with suspension wire attachment point, push-in terminals 5x1x1.5mm², light grey/ white/ black

OPTIONS AVAILABLE ON REQUEST:

LED	REFLECTOR AND OPTICS	CONTROL GEAR	CONNECTION	COLOUR
T830	OP	DALI	CBF3-2.0m clear	RAL
T840	DPRZ LT80		CBF3-3.0m clear	
			CBF5-2.0m clear	
			CBF5-3.0m clear	

OP

DPRZ LT80

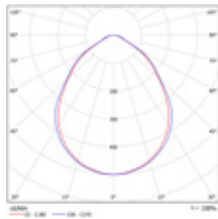
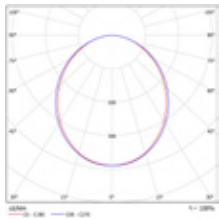



MOON A LED

Acoustic luminaires



DESCRIPTION: **Wall-mounted round decorative LED luminaire**
Light distribution type: indirect
Optical system: none
Housing: white steel body, RAL9003
Colour: made to the customer's specification

GENERAL DATA: **Mains voltage:** 220-240V, 50-60Hz
LED lifetime, h: 50000/L80B50
SDCM: 3
Protection class IEC: II
Ingress protection code: IP40
Mechanical impact resistance: IK02
Operating temperature range, °C: ta 0...+35

INSTALLATION: On the wall. Push-in terminal, 2x2x2.5mm²

ENVIRONMENT: Indoor

APPLICATION: Office, education, retail, public place

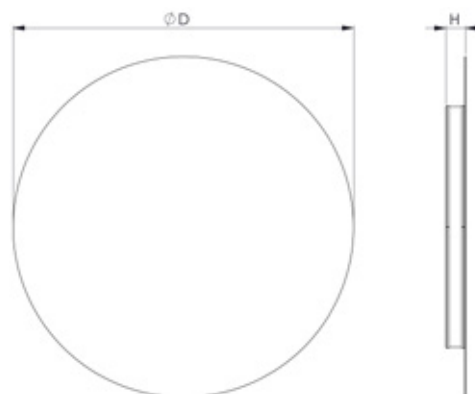

PRODUCT	DIAMETER, mm	HEIGHT, mm	LUMINAIRE OUTPUT*, lm	SYSTEM POWER*, W	SYSTEM EFFICACY*, lm/W	CRI	CCT*, K	WEIGHT, kg
Moon A LED1x700 J702 T840 M... (felt colour code)	450	40	659	8,5	78	80+	4000	2,4
Moon A LED1x1100 J703 T840 M... (felt colour code)	600	40	1099	14,1	78	80+	4000	3,5

*Tolerance range for optical and electrical data: ±10%. Values apply to an ambient temperature of 25°C. NORTHCLIFFE LIGHTING is constantly developing and improving its products. The right is reserved to change any product specifications without prior notification

OPTIONS AVAILABLE ON REQUEST:

LED	CONTROL GEAR	COLOUR
T830	DALI	M... (felt colour code) ¹
T840		

¹ List of material colour is found on page 238

STANDARD

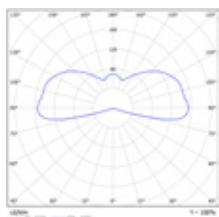

BLOCK A LED

Acoustic luminaires



DESCRIPTION: **Wall-mounted square decorative LED luminaire**
Light distribution type: indirect
Optical system: none
Housing: white steel body, RAL9003
Colour: made to the customer's specification

GENERAL DATA: **Mains voltage:** 220-240V, 50-60Hz
LED lifetime, h: 50000/L80B50
SDCM: 3
Protection class IEC: II
Ingress protection code: IP40
Mechanical impact resistance: IK02
Operating temperature range, °C: ta 0...+35

INSTALLATION: On the wall. Push-in terminal, 2x2x2.5mm²

ENVIRONMENT: Indoor

APPLICATION: Office, education, retail, public place

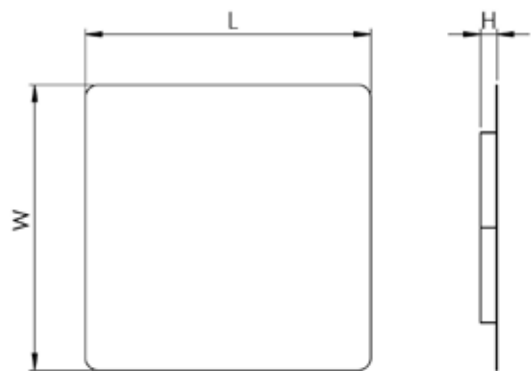

PRODUCT	DIAMETER, mm	HEIGHT, mm	LUMINAIRE OUTPUT*, lm	SYSTEM POWER*, W	SYSTEM EFFICACY*, lm/W	CRI	CCT*, K	WEIGHT, kg
Block A LED1x900 J704 T840 M... (felt colour code)	450	40	879	11,3	78	80+	4000	3,1
Block A LED1x1450 J705 T840 M... (felt colour code)	600	40	1406	18,1	78	80+	4000	4,5

*Tolerance range for optical and electrical data: ±10%. Values apply to an ambient temperature of 25°C. NORTHCLIFFE LIGHTING is constantly developing and improving its products. The right is reserved to change any product specifications without prior notification

OPTIONS AVAILABLE ON REQUEST:

LED	CONTROL GEAR	COLOUR
T830	DALI	M... (felt colour code) ¹
T840		

¹ List of material colour is found on page 238

STANDARD

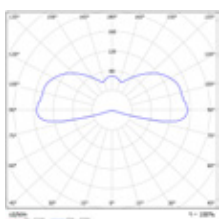

MATERIAL COLOUR FOR HAUD LED, FORMA A LED, QUADRO A LED, MOON A, BLOCK A LED LUMINAIRES:



Natural colour:

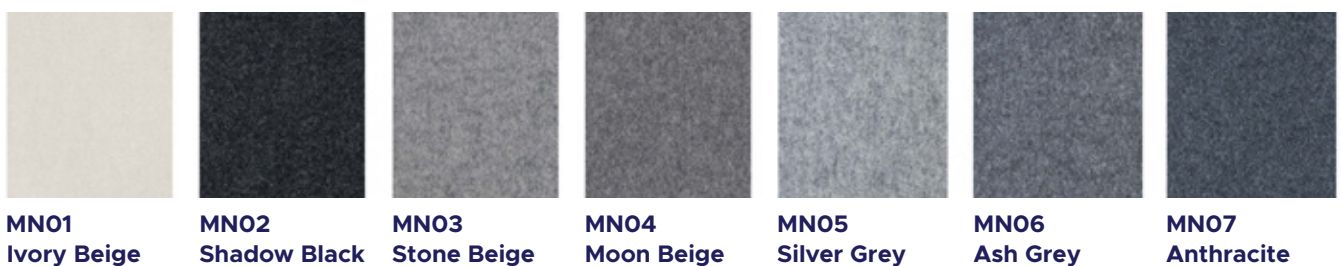

CLOUD LED

Acoustic luminaires



DESCRIPTION: Surface or suspended decorative LED luminaire
Light distribution type: direct
Optical system: thermoplastic diffuser
Housing: steel
Colour: white, RAL9003S

GENERAL DATA: Mains voltage: 220-240V, 0/50-60Hz / 50-60Hz
LED lifetime, h: 50000/L80B10
SDCM: 3
Protection class IEC: I
Ingress protection code: IP40
Mechanical impact resistance: IK02
Operating temperature range, °C: ta 0...+35

INSTALLATION: On the ceiling or suspended (accessories be ordered separately). Push-in terminal, 3x2x2,5mm²

ENVIRONMENT: Indoor

APPLICATION: Office, retail, public place

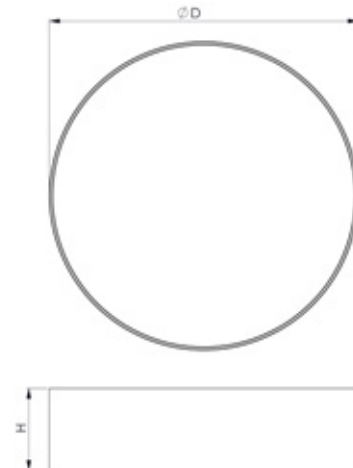

PRODUCT	DIAMETER, mm	HEIGHT, mm	LUMINAIRE OUTPUT*, lm	SYSTEM POWER*, W	SYSTEM EFFICACY*, lm/W	CRI	CCT*, K	WEIGHT, kg
Cloud LED1x1650 J682 T840 T08	300	150	1638	16,2	101	80+	4000	1,8
Cloud LED1x1450 J683 T840 T08	300	250	1411	16,2	87	80+	4000	1,8
Cloud LED1x1600 J684 T840 T08	300	400	1593	23,2	69	80+	4000	2,3
Cloud LED1x3350 J685 T840 T08	450	150	3311	32,4	102	80+	4000	2,4
Cloud LED1x2900 J686 T840 T08	450	250	2853	32,4	88	80+	4000	2,4
Cloud LED1x2750 J687 T840 T08	450	400	2708	38,2	71	80+	4000	2,9
Cloud LED1x4950 J688 T840 T08	600	150	4913	46,5	106	80+	4000	2,7
Cloud LED1x4250 J689 T840 T08	600	250	4233	46,5	91	80+	4000	2,7
Cloud LED1x4800 J698 T840 T08	600	400	4779	65,9	73	80+	4000	3,2
Cloud LED1x8750 J699 T840 T08	900	150	8701	78,1	111	80+	4000	7,2
Cloud LED1x7500 J700 T840 T08	900	250	7496	78,1	96	80+	4000	7,2
Cloud LED1x8150 J701 T840 T08	900	400	8125	104,5	78	80+	4000	7,7

*Tolerance range for optical and electrical data: ±10%. Values apply to an ambient temperature of 25°C. NORTHCLIFFE LIGHTING is constantly developing and improving its products. The right is reserved to change any product specifications without prior notification

AVAILABLE ACCESSORIES:



Product: Suspension MTG KIT SUSI
Description: Suspension wire set "I" type, 1.5m adjustable, 1pcs
**note - 3pcs MTG KIT SUSI for one fitting required*



Product: CAP cable 3x0.75 2.0m clear
Description: Cable 3x0.75mm² for suspended luminaire up to 2.0 meters, transparent



Product: Suspension MTG KIT Bootes C LED / Lodos L LED, white/ light grey/ black
Description: Suspension wire set with cap 3x"1" type, 1.5m adjustable, 1pcs



Product: CAP cable clip D6.3mm SET clear
Description: Cable and suspension wire clip set, 4pcs. For cable diameter up to 6,3mm and wire diameter 1mm



Product: CAP4, light grey/ white/ black
Description: Square decorative metal cap for hiding cable inlet with suspension wire attachment point, push-in terminals 3x1x1.5mm², light grey/ white/ black

Product: CAP5, light grey/ white/ black
Description: Square decorative metal cap for hiding cable inlet with suspension wire attachment point, push-in terminals 5x1x1.5mm², light grey/ white/ black

OPTIONS AVAILABLE ON REQUEST:

LED	CONTROL GEAR	CONNECTION	COLOUR
T830	DALI	CBF3-2.0m clear	T...(fabric colour code)
T840	EAIRB-S ¹	CBF3-3.0m clear	
	BLT	CBF5-2.0m clear	
	MW	CBF5-3.0m clear	

¹ Max wire length from EAIRB-M to last EAIRB-S - 11 m

MATERIAL COLOUR FOR CLOUD LED LUMINAIRE:



T01
White



T02
Off White



T03
Cream



T04
Champagne



T05
Pale Yellow



T06
Lemon



T07
Primrose
Yellow



T08
Orange



T09
Peach

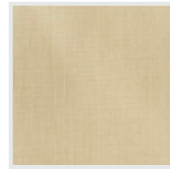

T10
Taupe



T11
Chocolate



T12
Sage



T13
Rose Pink



T14
Fuchsia



T15
Powder Pink



T16
Blush Pink

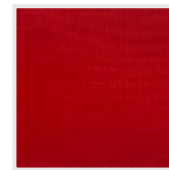

T17
Scarlett



T18
Burgundy



T19
Pale Green



T20
Lincoln Green



T21
Lime



T22
Pale
Turquoise



T23
Powder Blue



T24
Baby Blue



T25
Pale Blue



T26
Sky Blue

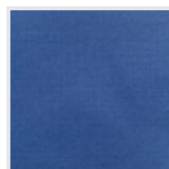

T27
Pale Denim

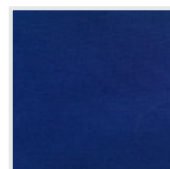

T28
Royal Blue



T29
Indigo Denim



T30
Navy Blue



T31
Dark Grey



T32
Mid Grey



T33
Pale Grey

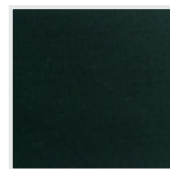

T34
Bottle Green

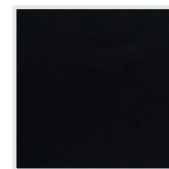

T35
Black

NORTHCLIFFE
making life brighter

CONTINUOUS LINE AND BATTEN LUMINAIRES

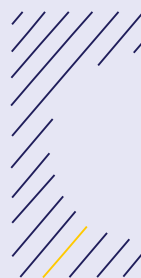



BLADE W LED

Continuous Line and Batten Luminaires



- DESCRIPTION:** Surface mounted industrial LED luminaire
Light distribution type: direct
Optical system: lenses
Housing: steel
Colour: white, RAL9003
-
- GENERAL DATA:** **Mains voltage:** 220-240V, 0/50-60Hz
LED lifetime, h: 100000/L80B10
SDCM: 3
Protection class IEC: I
Ingress protection code: IP23
Mechanical impact resistance: IK07
Operating temperature range, °C: ta -10...+40/-10...+35
-
- INSTALLATION:** On the ceiling or suspended (suspension brackets to be ordered separately). Push-in terminal, 5x2x2.5mm²
-
- ENVIRONMENT:** Indoor
-
- APPLICATION:** Retail, industry, warehouse, hall, public place

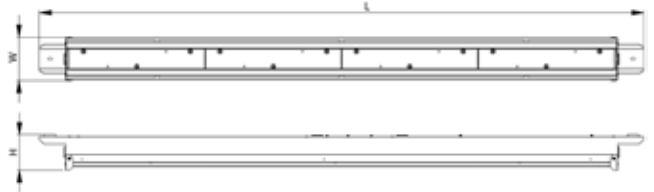

PRODUCT	LENGTH, mm	WIDTH, mm	HEIGHT, mm	LUMINAIRE OUTPUT*, lm	SYSTEM POWER*, W	SYSTEM EFFICACY*, lm/W	CRI	CCT*, K	WEIGHT, kg
Blade W LED1x5300 G415 T840 L75	1245	90	73	5260	31,3	168	80+	4000	3,4
Blade W LED1x7600 G416 T840 L75	1245	90	73	7554	41,6	181	80+	4000	3,4
Blade W LED1x10500 G417 T840 L75	1245	90	73	10466	59,8	175	80+	4000	3,4
Blade W LED1x6600 G419 T840 L75	1539	90	73	6575	38,7	170	80+	4000	4,0
Blade W LED1x9450 G420 T840 L75	1539	90	73	9442	51,5	183	80+	4000	4,0
Blade W LED1x13100 G421 T840 L75	1539	90	73	13082	74,8	175	80+	4000	4,0

*Tolerance range for optical and electrical data: ±10%. Values apply to an ambient temperature of 25°C. NORTHCLIFFE LIGHTING is constantly developing and improving its products. The right is reserved to change any product specifications without prior notification
 Note - for models: G415, G419 - only every second LED lights up

AVAILABLE ACCESSORIES:



Product: GRID MTG KIT Blade W LED 1.2m RAL9003
Description: Protective grid for Blade W/Z LED luminaires 1.2m, white

Product: GRID MTG KIT Blade W LED 1.5m RAL9003
Description: Protective grid for Blade W/Z LED luminaires 1.5m, white



Product: Remote Control HRC-11
Description: Integrated smart sensor for high ceiling (up to 16m) with wireless communication and grouping possibilities for lighting control
 *note - remote control for HBPIR15m-M



Product: Wire suspension BRACKETS - Blade W/Z LED
Description: Wire suspension brackets for Blade W/Z LED, galvanized steel, 2pcs

OPTIONS AVAILABLE ON REQUEST:

LED	REFLECTOR AND OPTICS	CONTROL GEAR	SENSORS	EMERGENCY	CONNECTION
T830	L30	DALI	HBPIR15m-M	EM3 ⁵	L1 ⁶
T840	L40x75	HBEAIRB-M ^{1 2 3 4}	DALI HBPIRD15m-M	EM3B ⁵	L2 ⁶
	L75	HBEAIRB-S ^{2 3 4}	KRBLT HBPIR15m-M	EM3A ⁵	L3 ⁶
	L75W	COR	DALI KRBLT HBPIRD15m-M	EM3D ⁵	2G
	L90W	COR1min			WIE3
	L1A18	COR30min			WIE5
	L2A25				WIE5D
					2WIE3
					2WIE5
					2WIE5D

- 1 The impact protection rating of the HBEAIRB-M option is IK05
- 2 Max system size 1x HBEAIRB-M + 3x HBEAIRB-S
- 3 Max wire length from HBEAIRB-M to last HBEAIRB-S - 11 m
- 4 EAIRB option is not available for model G415
- 5 Operating temperature range for Luminaires with EM option, °C: ta 0... +35
- 6 Please specify one of L1, L2, L3 option for WIE5 and 2WIE5 options

L30

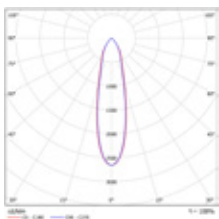

L40x75

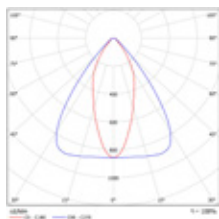

L75

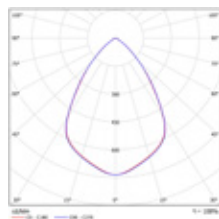

L75W

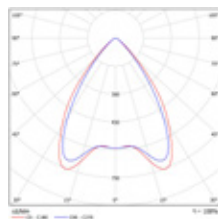

L90W

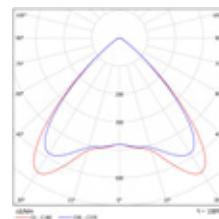

L1A18

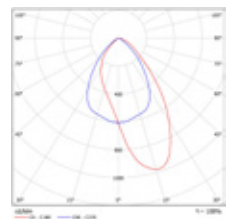

L2A25

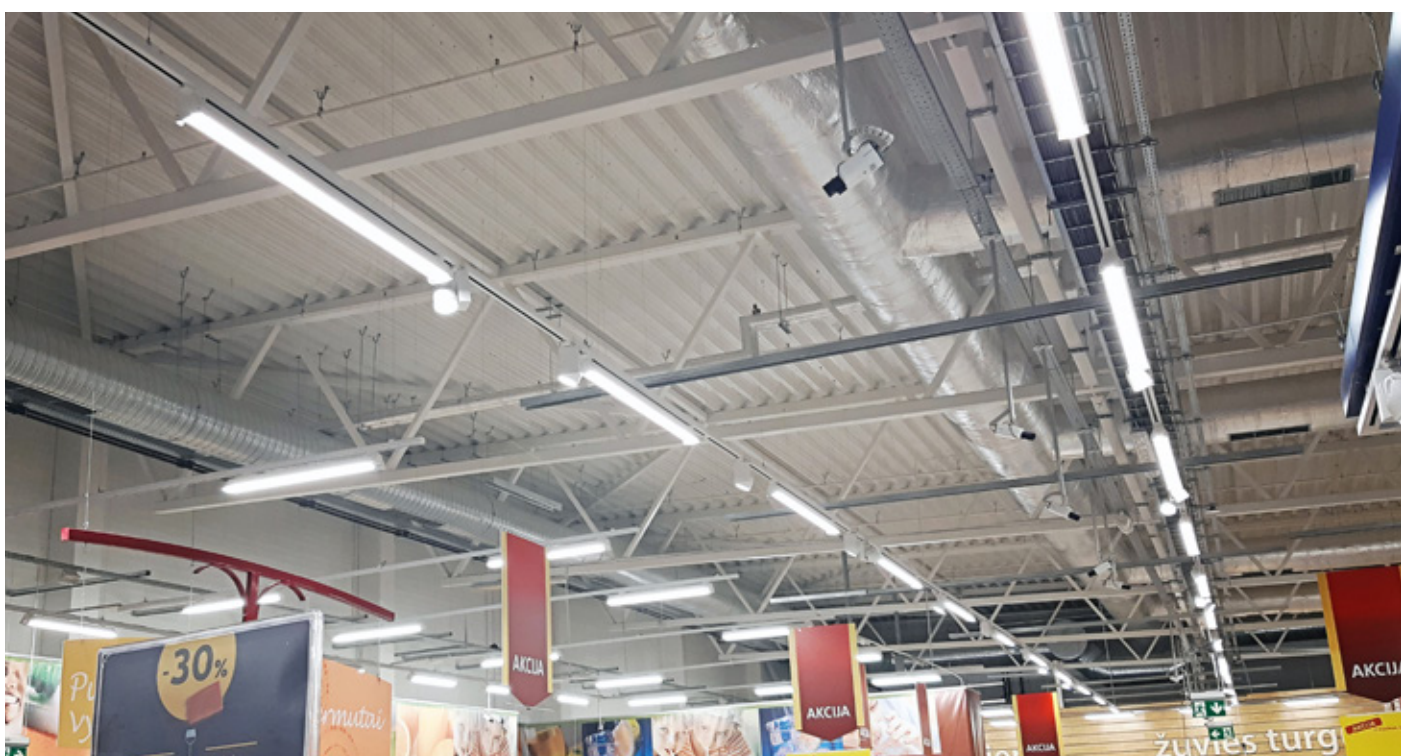
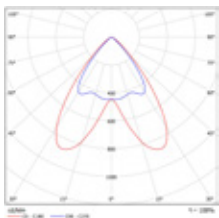

BLADE Z LED

Continuous Line and Batten Luminaires



DESCRIPTION: **Surface mounted industrial LED luminaire**
Light distribution type: direct
Optical system: lenses
Housing: zinc coated steel
Colour: light grey

GENERAL DATA: **Mains voltage:** 220-240V, 0/50-60Hz
LED lifetime, h: 100000/L80B10
Protection class IEC: I
SDCM: 3
Ingress protection code: IP23
Mechanical impact resistance: IK07
Operating temperature range, °C: ta -10...+40/-10...+35

INSTALLATION: On the ceiling or suspended (suspension brackets to be ordered separately). Push-in terminal, 5x2x2.5mm²

ENVIRONMENT: Indoor

APPLICATION: Retail, industry, warehouse, hall, public place

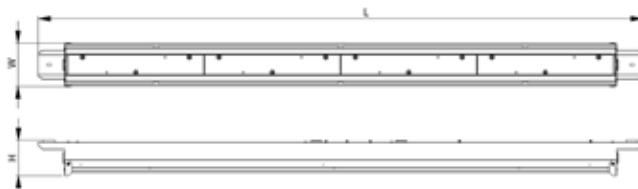

PRODUCT	LENGTH, mm	WIDTH, mm	HEIGHT, mm	LUMINAIRE OUTPUT*, lm	SYSTEM POWER*, W	SYSTEM EFFICACY*, lm/W	CRI	CCT*, K	WEIGHT, kg
Blade Z LED1x5300 G423 T840 L75	1245	90	73	5260	31,3	168	80+	4000	3,4
Blade Z LED1x7600 G424 T840 L75	1245	90	73	7554	41,6	181	80+	4000	3,4
Blade Z LED1x10500 G425 T840 L75	1245	90	73	10466	59,8	175	80+	4000	3,4
Blade Z LED1x6600 G427 T840 L75	1539	90	73	6575	38,7	170	80+	4000	4,0
Blade Z LED1x9450 G428 T840 L75	1539	90	73	9442	51,5	183	80+	4000	4,0
Blade Z LED1x13100 G426 T840 L75	1539	90	73	13082	74,8	175	80+	4000	4,0

*Tolerance range for optical and electrical data: ±10%. Values apply to an ambient temperature of 25°C. NORTHCLIFFE LIGHTING is constantly developing and improving its products. The right is reserved to change any product specifications without prior notification

Note - for models: G423, G427 - only every second LED lights up

AVAILABLE ACCESSORIES:



Product: GRID MTG KIT Blade W LED 1.2m RAL9003
Description: Protective grid for Blade W/Z LED luminaires 1.2m, white

Product: GRID MTG KIT Blade W LED 1.5m RAL9003
Description: Protective grid for Blade W/Z LED luminaires 1.5m, white



Product: Wire suspension BRACKETS - Blade W/Z LED
Description: Wire suspension brackets for Blade W/Z LED, galvanized steel, 2pcs



Product: Remote Control HRC-11
Description: Integrated smart sensor for high ceiling (up to 16m) with wireless communication and grouping possibilities for lighting control
 *note - remote control for HBPIR15m-M

OPTIONS AVAILABLE ON REQUEST:

LED	REFLECTOR AND OPTICS	CONTROL GEAR	SENSORS	EMERGENCY	CONNECTION
T830	L30	DALI	HBPIR15m-M	EM3 ⁵	L1 ⁶
T840	L40x75	HBEAIRB-M ^{1 2 3 4}	DALI HBPIRD15m-M	EM3B ⁵	L2 ⁶
	L75	HBEAIRB-S ^{2 3 4}	KRBLT HBPIR15m-M	EM3A ⁵	L3 ⁶
	L75W	COR	DALI KRBLT HBPIRD15m-M	EM3D ⁵	2G
	L90W	COR1min			WIE3
	L1A18	COR30min			WIE5
	L2A25				WIE5D
					2WIE3
					2WIE5
					2WIE5D

- 1 The impact protection rating of the HBEAIRB-M option is IK05
- 2 Max system size 1x HBEAIRB-M + 3x HBEAIRB-S
- 3 Max wire length from HBEAIRB-M to last HBEAIRB-S - 11 m
- 4 EAIRB option is not available for model G423
- 5 Operating temperature range for Luminaires with EM option, °C: ta 0... +35
- 6 Please specify one of L1, L2, L3 option for WIE5 and 2WIE5 options

L30

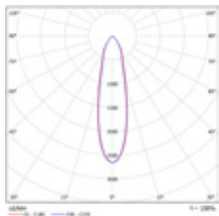

L40x75

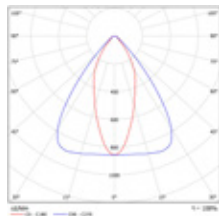

L75

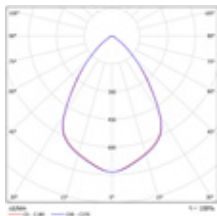

L75W

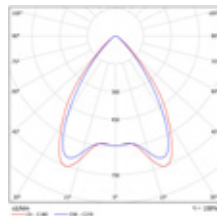

L90W

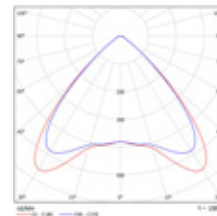

L1A18

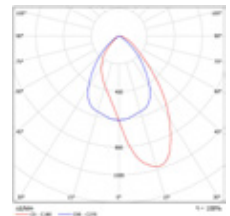

L2A25

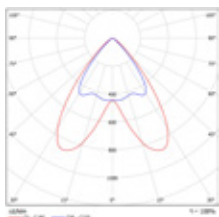

SHOP A LED

Continuous Line and Batten Luminaires

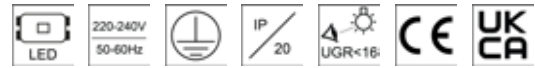

DESCRIPTION: Suspended continuous line LED luminaire
Light distribution type: direct
Optical system: lenses
Housing: steel
Colour: white, RAL9003

GENERAL DATA: **Mains voltage:** 220-240V, 0/50-60Hz
LED lifetime, h: 100000/L80B10
SDCM: 3
Protection class IEC: I
Ingress protection code: IP20
Mechanical impact resistance: IK05
Operating temperature range, °C: ta 0...+35/+40

INSTALLATION: Suspended linier (suspension brackets and I-join kit included with each luminaire). Through wired, 5x1.5mm², two 5-pole connectors, plug and socket

ENVIRONMENT: Indoor

APPLICATION: Retail, hall, public place



PRODUCT	LENGTH, mm	WIDTH, mm	HEIGHT, mm	LUMINAIRE OUTPUT*, lm	SYSTEM POWER*, W	SYSTEM EFFICACY*, lm/W	CRI	CCT*, K	WEIGHT, kg
Shop A LED1x3800 J163 T840 L75 LO1 L1 LL	1132	45	65	3796	21,8	174	80+	4000	3,2
Shop A LED1x5300 J164 T840 L75 LO2 L1 LL	1132	45	65	5260	31,7	166	80+	4000	3,2
Shop A LED1x5550 J165 T840 L75 LO3 L1 LL	1132	45	65	5523	30,0	184	80+	4000	3,2
Shop A LED1x6600 J166 T840 L75 LO4 L1 LL	1132	45	65	6567	35,9	183	80+	4000	3,2
Shop A LED1x7600 J167 T840 L75 LO5 L1 LL	1132	45	65	7554	41,6	182	80+	4000	3,2
Shop A LED1x4750 J168 T840 L75 LO1 L1 LL	1413	45	65	4746	27,0	176	80+	4000	3,5
Shop A LED1x6600 J169 T840 L75 LO2 L1 LL	1413	45	65	6575	38,7	170	80+	4000	3,5
Shop A LED1x6950 J170 T840 L75 LO3 L1 LL	1413	45	65	6904	36,7	188	80+	4000	3,5
Shop A LED1x8250 J171 T840 L75 LO4 L1 LL	1413	45	65	8209	44,4	185	80+	4000	3,5
Shop A LED1x9450 J172 T840 L75 LO5 L1 LL	1413	45	65	9442	51,5	183	80+	4000	3,5
Shop A LED1x9500 J173 T840 L75 LO1 L1 LL	2818	45	65	9491	51,6	184	80+	4000	5,0
Shop A LED1x13150 J174 T840 L75 LO2 L1 LL	2818	45	65	13150	75,0	175	80+	4000	5,0
Shop A LED1x13850 J175 T840 L75 LO3 L1 LL	2818	45	65	13808	72,7	190	80+	4000	5,0
Shop A LED1x16450 J176 T840 L75 LO4 L1 LL	2818	45	65	16418	87,0	189	80+	4000	5,0
Shop A LED1x18900 J177 T840 L75 LO5 L1 LL	2818	45	65	18884	101,9	185	80+	4000	5,0

*Tolerance range for optical and electrical data: ±10%. Values apply to an ambient temperature of 25°C. NORTHCLIFFE LIGHTING is constantly developing and improving its products. The right is reserved to change any product specifications without prior notification

Note - for versions: LO1, LO2 - only every second LED lights up

AVAILABLE ACCESSORIES:



Product: Suspension MTG KIT SUSI
Description: Suspension wire set "I" type, 1.5m adjustable, 1pcs
**note - 2pcs MTG SUSI KIT for length up to 2000mm, 3pcs MTG SUSI KIT for lengths 2000 - 3000mm*



Product: CAP cable clip D6.3mm SET clear
Description: Cable and suspension wire clip set, 4pcs. For cable diameter up to 6,3mm and wire diameter 1mm



Product: BLANK Shop A LED L1132mm RAL9003
Description: Blank part kit for connecting luminaires in-line 1134mm long, 1pcs

Product: BLANK Shop A LED L1413mm RAL9003
Description: Blank part kit for connecting luminaires in-line 1415mm long, 1pcs

Product: BLANK Shop A LED L2818mm RAL9003
Description: Blank part kit for connecting luminaires in-line 2820mm long, 1pcs

**BLANK Shop A LED with Capheus B LED luminaire
 Ask for special models



Product: CAP cable 3x0.75 2.0m clear
Description: Cable 3x0.75mm² for suspended luminaire up to 2.0 meters, transparent



Product: END CAP Shop A LED RAL9003
Description: End cap kit for Shop A LED luminaires, 1pcs (extra)



Product: CAP4, light grey/ white/ black
Description: Square decorative metal cap for hiding cable inlet with suspension wire attachment point, push-in terminals 3x1x1.5mm², light grey/ white/ black

Product: CAP5, light grey/ white/ black
Description: Square decorative metal cap for hiding cable inlet with suspension wire attachment point, push-in terminals 5x1x1.5mm², light grey/ white/ black



Product: Power supply socket 1602/VCB-M-5 5x1.5-2.5mm²

Description: 5-pole socket (Stucchi - 1602/VCB-M-5) for power supply, 1pcs
**note - please use power supply socket for first in-line luminaire connection to power source*

OPTIONS AVAILABLE ON REQUEST:

LED	REFLECTOR AND OPTICS	LIGHT OUTPUT LEVELS	CONTROL GEAR	EMERGENCY	CONNECTION	COLOUR
T830	L30	LO1...5	DALI 2WIE5D ¹	EM3 ²	L1	RAL
T840	L40x75			EM3B ²	L2	
T930	L75			EM3A ²	L3	
T940	L75W			DALI EM3D 2WIE5D ³		
	L90W					
	L100					
	L1A18-L					
	L1A18-R					
	L2A25					

- 1 With 2WIE5D option luminaire is throughwired with only one phase
- 2 For EM option power supply L3 phase is used. Luminaire is 2LIN and control options are not compatible
- 3 DALI EM3D 2WIE5D option luminaire is throughwired with only one phase. Therefore, luminaire switching on/off is only possible with DALI signal
- 4 Operating temperature range for Luminaires with EM option, °C: ta 0... +35

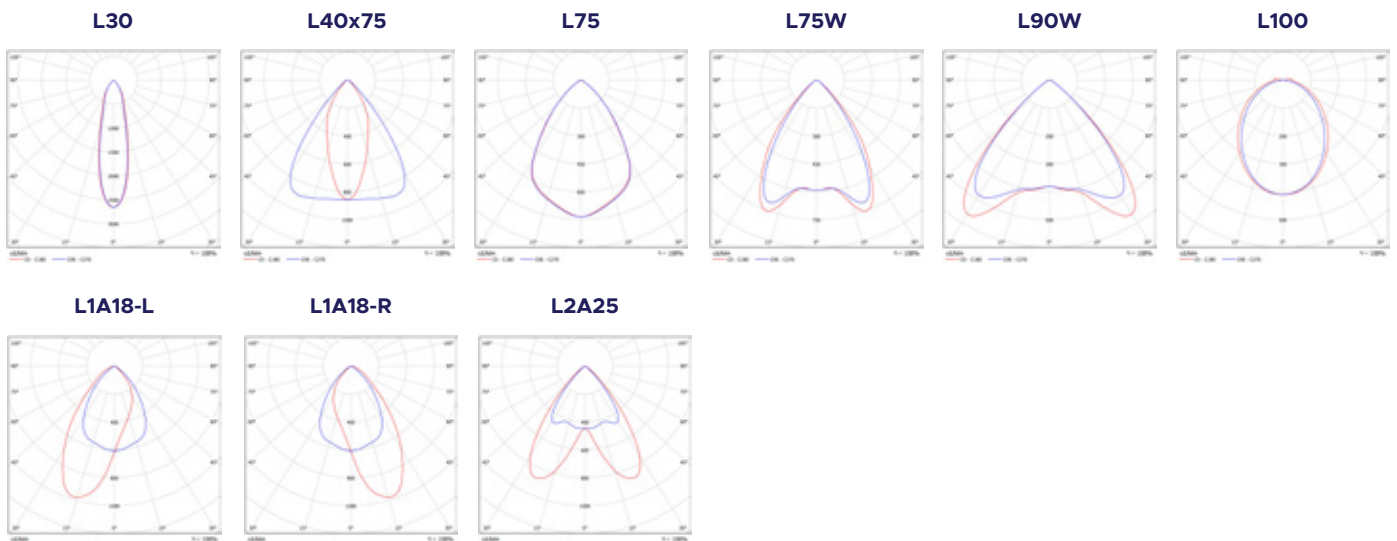

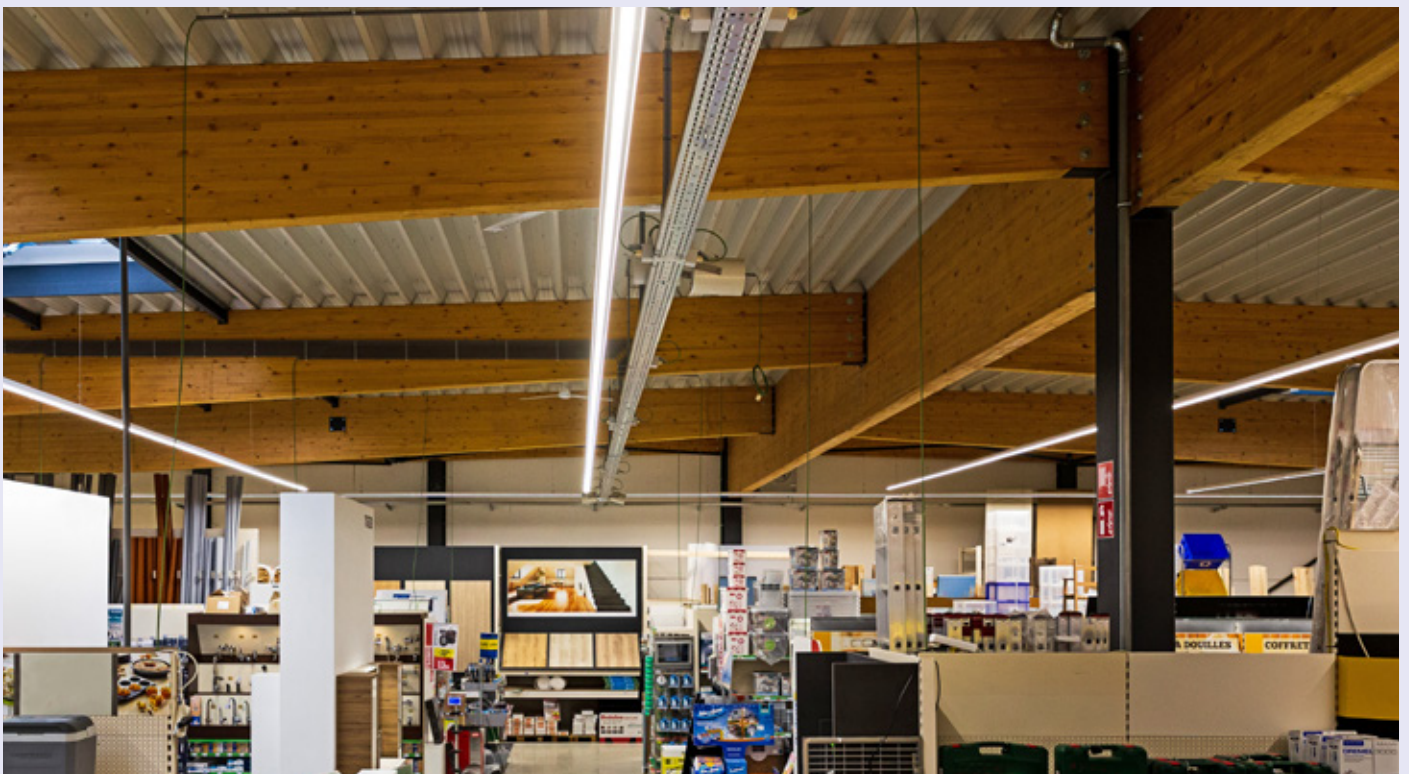

SHOP A LED CORNER90

Continuous Line and Batten Luminaires



DESCRIPTION: Suspended continuous line LED luminaire
Light distribution type: direct
Optics: lenses
Housing: steel
Colour: white, RAL9003

GENERAL DATA: **Mains voltage:** 220-240V, 0/50-60Hz
LED lifetime, h: 100000/L80B10
SDCM: 3
Protection class IEC: I
Ingress protection code: IP20
Mechanical impact resistance: IK05
Operating temperature range, °C: ta 0...+35/+40

INSTALLATION: Suspended L-join (suspension brackets and I-join kit included with each luminaire). Through wired, 5x1.5mm², two 5-pole connectors, plug and socket

ENVIRONMENT: Indoor

APPLICATION: Retail, hall, public place

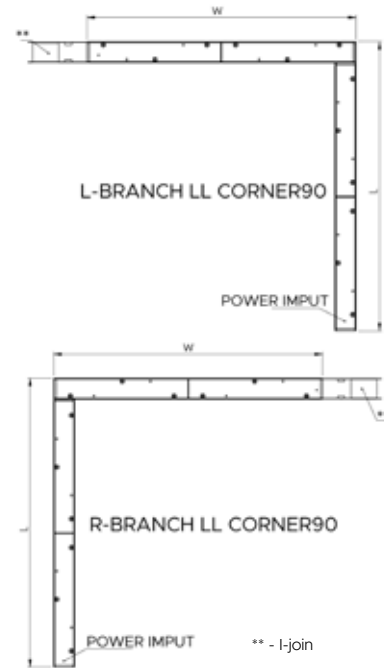

PRODUCT	LENGTH, mm	WIDTH, mm	HEIGHT, mm	LUMINAIRE OUTPUT*, lm	SYSTEM POWER*, W	SYSTEM EFFICACY*, lm/W	CRI	CCT*, K	WEIGHT, kg
Shop A LED1x3800 J183 T840 L75 LO1 L1 L-BRANCH LL CORNER90	615	571	65	3796	21,8	174	80+	4000	3,3
Shop A LED1x5300 J184 T840 L75 LO2 L1 L-BRANCH LL CORNER90	615	571	65	5260	31,7	166	80+	4000	3,3
Shop A LED1x5550 J185 T840 L75 LO3 L1 L-BRANCH LL CORNER90	615	571	65	5523	30,0	184	80+	4000	3,3
Shop A LED1x6600 J186 T840 L75 LO4 L1 L-BRANCH LL CORNER90	615	571	65	6567	35,9	183	80+	4000	3,3
Shop A LED1x7600 J187 T840 L75 LO5 L1 L-BRANCH LL CORNER90	615	571	65	7554	41,6	182	80+	4000	3,3
Shop A LED1x3800 J183 T840 L75 LO1 L1 R-BRANCH LL CORNER90	615	571	65	3796	21,8	174	80+	4000	3,3
Shop A LED1x5300 J184 T840 L75 LO2 L1 R-BRANCH LL CORNER90	615	571	65	5260	31,7	166	80+	4000	3,3
Shop A LED1x5550 J185 T840 L75 LO3 L1 R-BRANCH LL CORNER90	615	571	65	5523	30,0	184	80+	4000	3,3
Shop A LED1x6600 J186 T840 L75 LO4 L1 R-BRANCH LL CORNER90	615	571	65	6567	35,9	183	80+	4000	3,3
Shop A LED1x7600 J187 T840 L75 LO5 L1 R-BRANCH LL CORNER90	615	571	65	7554	41,6	182	80+	4000	3,3

*Tolerance range for optical and electrical data: ±10%. Values apply to an ambient temperature of 25°C. NORTHCLIFFE LIGHTING is constantly developing and improving its products. The right is reserved to change any product specifications without prior notification

Note - for versions: LO1, LO2 - only every second LED lights up

Note - plug is positioned at the longest end of the luminaire and socket is out at a branch. If changes to be made please discuss project with your sales manager

AVAILABLE ACCESSORIES:



Product: Suspension MTG KIT SUSI
Description: Suspension wire set "I" type, 1.5m adjustable, 1pcs
**note - 2pcs MTG SUSI KIT for length up to 2000mm, 3pcs MTG SUSI KIT for lengths 2000 - 3000mm*



Product: CAP cable 3x0.75 2.0m clear
Description: Cable 3x0.75mm² for suspended luminaire up to 2.0 meters, transparent



Product: CAP cable clip D6.3mm SET clear
Description: Cable and suspension wire clip set, 4pcs. For cable diameter up to 6,3mm and wire diameter 1mm



Product: END CAP Shop A LED RAL9003
Description: End cap kit for Shop A LED luminaires, 1pcs (extra)



Product: BLANK Shop A LED L-BRANCH CORNER90 RAL9003
Description: Blank part kit for connecting luminaires in-line "L" shaped with a branch to the left, 1pcs



Product: BLANK Shop A LED R-BRANCH CORNER90 RAL9003
Description: Blank part kit for connecting luminaires in-line "L" shaped with a branch to the right, 1pcs



Product: Power supply socket 1602/VCB-M-5 5x1.5-2.5mm²
Description: 5-pole socket (Stucchi - 1602/VCB-M-5) for power supply, 1pcs
**note - please use power supply socket for first in-line luminaire connection to power source*

Product: CAP4, light grey/ white/ black
Description: Square decorative metal cap for hiding cable inlet with suspension wire attachment point, push-in terminals 3x1x1.5mm², light grey/ white/ black

Product: CAP5, light grey/ white/ black
Description: Square decorative metal cap for hiding cable inlet with suspension wire attachment point, push-in terminals 5x1x1.5mm², light grey/ white/ black

OPTIONS AVAILABLE ON REQUEST:

LED	REFLECTOR AND OPTICS	LIGHT OUTPUT LEVELS	CONTROL GEAR	CONNECTION	COLOUR
T830	L30	L01...5	DALI 2WIE5D ¹	L1	RAL
T840	L40x75			L2	
T930	L75			L3	
T940	L75W				
	L90W				
	L100				
	L2A25				

¹ With 2WIE5D option luminaire is throughwired with only one phase

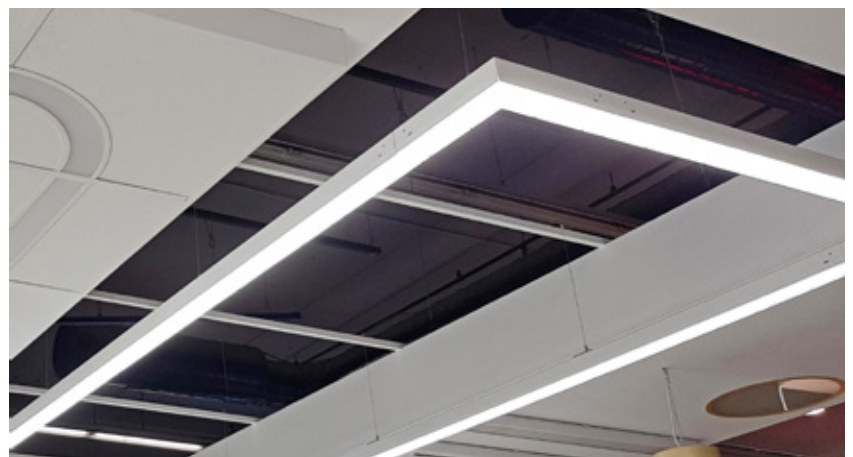
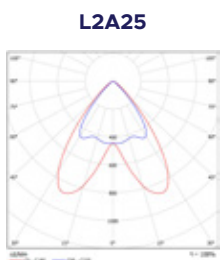
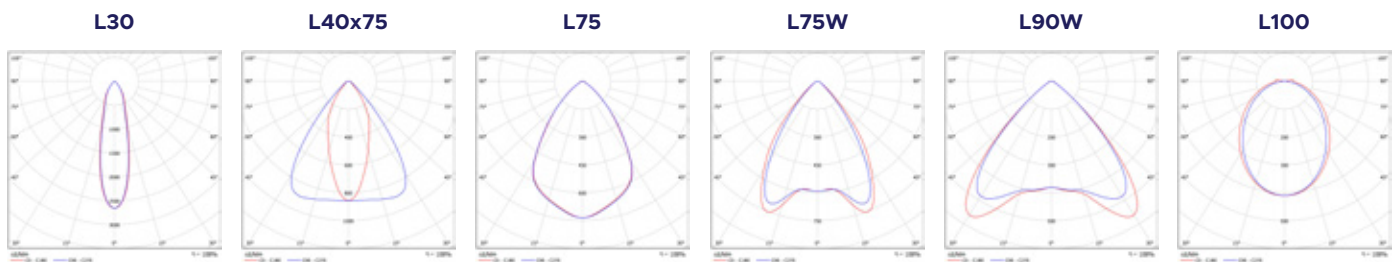

SHOP A LED CORNER180

Continuous Line and Batten Luminaires



DESCRIPTION: Suspended continuous line LED luminaire

Light distribution type: direct

Optics: lenses

Housing: steel

Colour: white, RAL9003

GENERAL DATA: Mains voltage: 220-240V, 0/50-60Hz

LED lifetime, h: 100000/L80B10

SDCM: 3

Protection class IEC: I

Ingress protection code: IP20

Mechanical impact resistance: IK05

Operating temperature range, °C: ta 0...+35/+40

INSTALLATION: Suspended T-join (suspension brackets and I-join kit included with each luminaire). Select CTR-BRANCH or BRANCH versions according to system layout. Through wired, 5x1.5mm², three 5-pole connectors, plug and sockets

ENVIRONMENT: Indoor

APPLICATION: Retail, hall, public place

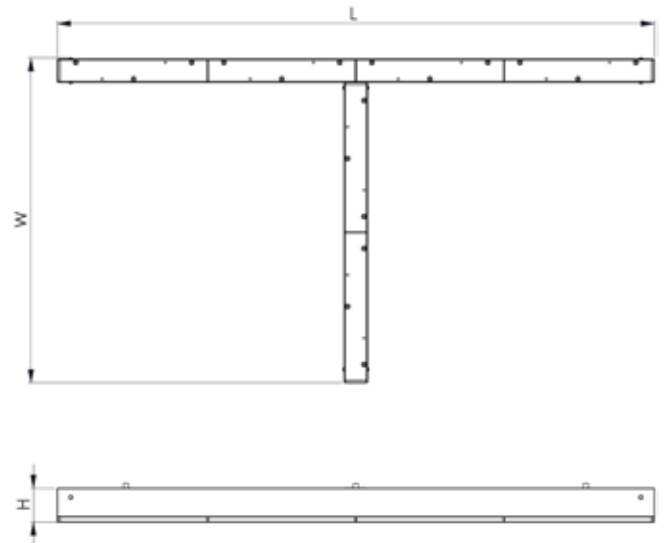

PRODUCT	LENGTH, mm	WIDTH, mm	HEIGHT, mm	LUMINAIRE OUTPUT*, lm	SYSTEM POWER*, W	SYSTEM EFFICACY*, lm/W	CRI	CCT*, K	WEIGHT, kg
Shop A LED1x5700 J178 T840 L75 LO1 L1 L-BRANCH LL CORNER180	1132	615	65	5695	32,4	176	80+	4000	4,1
Shop A LED1x7900 J179 T840 L75 LO2 L1 L-BRANCH LL CORNER180	1132	615	65	7890	46,5	170	80+	4000	4,1
Shop A LED1x8300 J180 T840 L75 LO3 L1 L-BRANCH LL CORNER180	1132	615	65	8285	44,1	188	80+	4000	4,1
Shop A LED1x9900 J181 T840 L75 LO4 L1 L-BRANCH LL CORNER180	1132	615	65	9851	52,7	187	80+	4000	4,1
Shop A LED1x11350 J182 T840 L75 LO5 L1 L-BRANCH LL CORNER180	1132	615	65	11331	61,8	183	80+	4000	4,1
Shop A LED1x5700 J178 T840 L75 LO1 L1 R-BRANCH LL CORNER180	1132	615	65	5695	32,4	176	80+	4000	4,1
Shop A LED1x7900 J179 T840 L75 LO2 L1 R-BRANCH LL CORNER180	1132	615	65	7890	46,5	170	80+	4000	4,1
Shop A LED1x8300 J180 T840 L75 LO3 L1 R-BRANCH LL CORNER180	1132	615	65	8285	44,1	188	80+	4000	4,1
Shop A LED1x9900 J181 T840 L75 LO4 L1 R-BRANCH LL CORNER180	1132	615	65	9851	52,7	187	80+	4000	4,1
Shop A LED1x11350 J182 T840 L75 LO5 L1 R-BRANCH LL CORNER180	1132	615	65	11331	61,8	183	80+	4000	4,1

PRODUCT	LENGTH, mm	WIDTH, mm	HEIGHT, mm	LUMINAIRE OUTPUT*, lm	SYSTEM POWER*, W	SYSTEM EFFICACY*, lm/W	CRI	CCT*, K	WEIGHT, kg
Shop A LED1x5700 J565 T840 L75 LO1 L1 L-CTR-BRANCH LL CORNER180	1185	571	65	3417	19,4	176	80+	4000	3,7
Shop A LED1x7900 J566 T840 L75 LO2 L1 L-CTR-BRANCH LL CORNER180	1185	571	65	4734	27,9	170	80+	4000	3,7
Shop A LED1x8300 J567 T840 L75 LO3 L1 L-CTR-BRANCH LL CORNER180	1185	571	65	4971	26,4	188	80+	4000	3,7
Shop A LED1x9900 J568 T840 L75 LO4 L1 L-CTR-BRANCH LL CORNER180	1185	571	65	5910	31,6	187	80+	4000	3,7
Shop A LED1x11350 J569 T840 L75 LO5 L1 L-CTR-BRANCH LL CORNER180	1185	571	65	6798	37,1	183	80+	4000	3,7
Shop A LED1x5700 J565 T840 L75 LO1 L1 R-CTR-BRANCH LL CORNER180	1185	571	65	5695	32,4	176	80+	4000	3,7
Shop A LED1x7900 J566 T840 L75 LO2 L1 R-CTR-BRANCH LL CORNER180	1185	571	65	7890	46,5	170	80+	4000	3,7
Shop A LED1x8300 J567 T840 L75 LO3 L1 R-CTR-BRANCH LL CORNER180	1185	571	65	8285	44,1	188	80+	4000	3,7
Shop A LED1x9900 J568 T840 L75 LO4 L1 R-CTR-BRANCH LL CORNER180	1185	571	65	9851	52,7	187	80+	4000	3,7
Shop A LED1x11350 J569 T840 L75 LO5 L1 R-CTR-BRANCH LL CORNER180	1185	571	65	11331	61,8	183	80+	4000	3,7

*Tolerance range for optical and electrical data: ±10%. Values apply to an ambient temperature of 25°C. NORTHCLIFFE LIGHTING is constantly developing and improving its products. The right is reserved to change any product specifications without prior notification

Note - for versions: LO1, LO2 - only every second LED lights up

Note - plug is positioned at the longest end of the luminaire and socket(s) are out at each branch. If changes to be made please discuss project with your sales manager

AVAILABLE ACCESSORIES:



Product: Suspension MTG KIT SUSI
Description: Suspension wire set "I" type, 1.5m adjustable, 1pcs
**note - 2pcs MTG SUSI KIT for length up to 2000mm, 3pcs MTG SUSI KIT for lengths 2000 - 3000mm*



Product: CAP cable 3x0.75 2.0m clear
Description: Cable 3x0.75mm² for suspended luminaire up to 2.0 meters, transparent



Product: CAP cable clip D6.3mm SET clear
Description: Cable and suspension wire clip set, 4pcs. For cable diameter up to 6,3mm and wire diameter 1mm



Product: END CAP Shop A LED RAL9003
Description: End cap kit for Shop A LED luminaires, 1pcs (extra)

Product: BLANK Shop A LED L-BRANCH CORNER180 RAL9003
Description: Blank part kit for connecting luminaires in-line "T" shaped with a branch to the left, 1pcs

Product: BLANK Shop A LED R-BRANCH CORNER180 RAL9003
Description: Blank part kit for connecting luminaires in-line "T" shaped with a branch to the right, 1pcs



Product: CAP4, light grey/ white/ black
Description: Square decorative metal cap for hiding cable inlet with suspension wire attachment point, push-in terminals 3x1x1.5mm², light grey/ white/ black



Product: BLANK Shop A LED L-CTR-BRANCH CORNER180 RAL9003
Description: Blank part kit for connecting luminaires in-line "T" shaped with a centre branch to the left, 1pcs

Product: BLANK Shop A LED R-CTR-BRANCH CORNER180 RAL9003
Description: Blank part kit for connecting luminaires in-line "T" shaped with a centre branch to the right, 1pcs



Product: Power supply socket 1602/VCB-M-5 5x1.5-2.5mm²
Description: 5-pole socket (Stucchi - 1602/VCB-M-5) for power supply, 1pcs
**note - please use power supply socket for first in-line luminaire connection to power source*

OPTIONS AVAILABLE ON REQUEST:

LED	REFLECTOR AND OPTICS	LIGHT OUTPUT LEVELS	CONTROL GEAR	CONNECTION	COLOUR
T830	L30	LO1...5	DALI 2WIE5D ¹	L1	RAL
T840	L40x75			L2	
T930	L75			L3	
T940	L75W				
	L90W				
	L100				
	L2A25				

¹ With 2WIE5D option luminaire is throughwired with only one phase

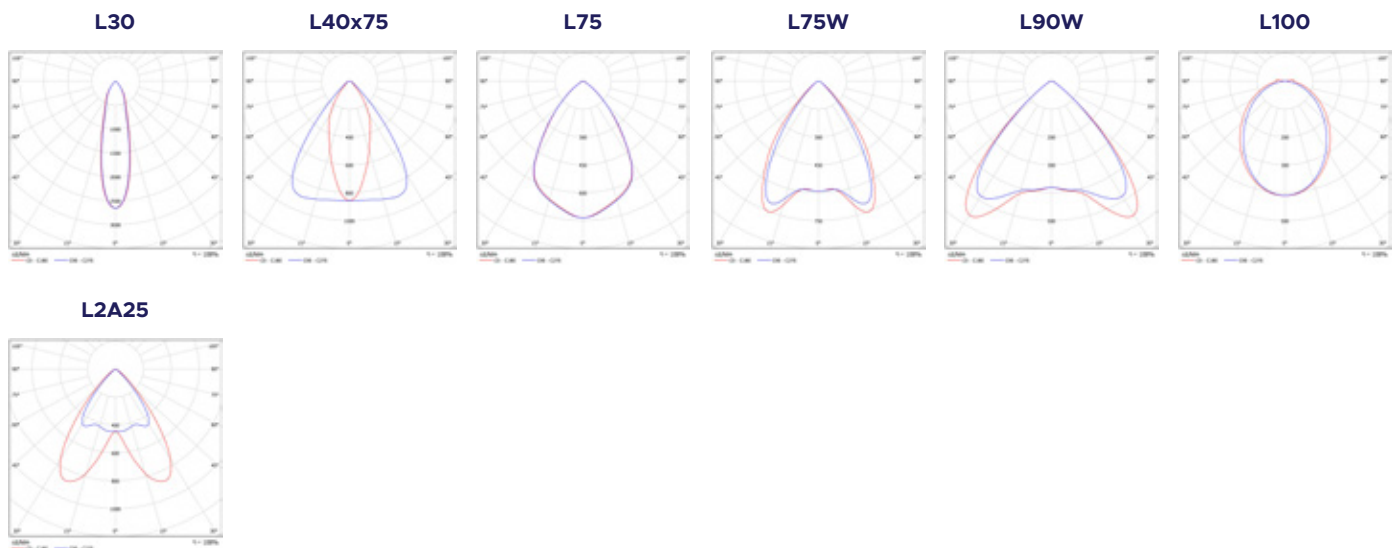

L-BRANCH LL CORNER180

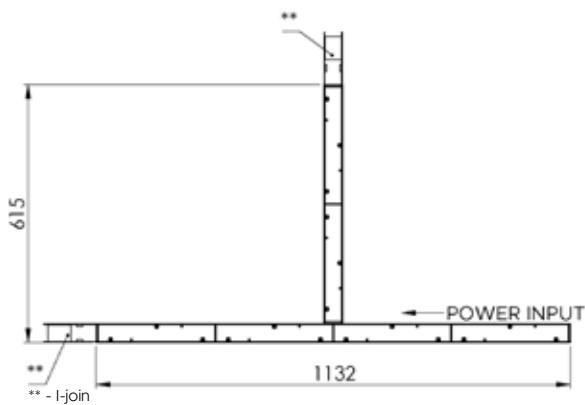

L-CTR-BRANCH LL CORNER180

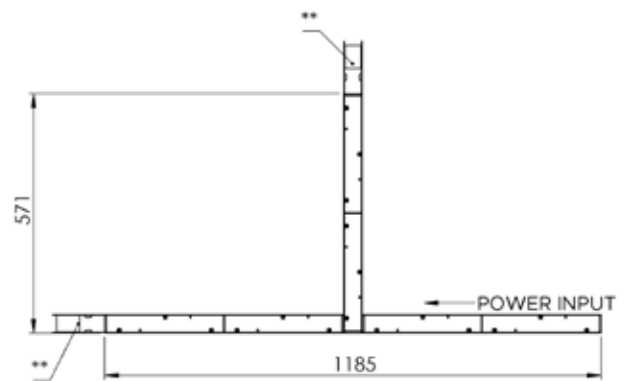

R-BRANCH LL CORNER180

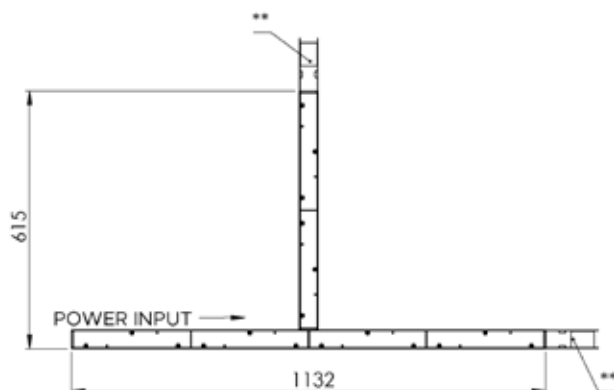

R-CTR-BRANCH LL CORNER180

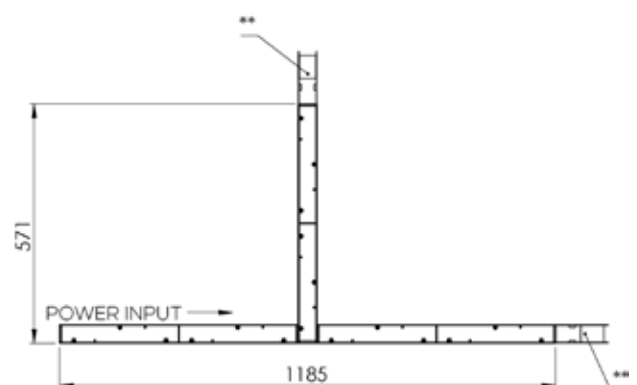

SHOP A LED CORNER360

Continuous Line and Batten Luminaires

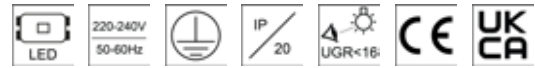

DESCRIPTION: **Suspended continuous line LED luminaire**
Light distribution type: direct
Optical system: lenses
Housing: steel
Colour: white, RAL9003

GENERAL DATA: **Mains voltage:** 220-240V, 0/50-60Hz
LED lifetime, h: 100000/L80B10
SDCM: 3
Protection class IEC: I
Ingress protection code: IP20
Mechanical impact resistance: IK05
Operating temperature range, °C: ta 0...+35/+40

INSTALLATION: Suspended X-join (suspension brackets and I-join kit included with each luminaire). Through wired, 5x1.5mm², two 5-pole connectors, plug and sockets

ENVIRONMENT: Indoor

APPLICATION: Retail, hall, public place

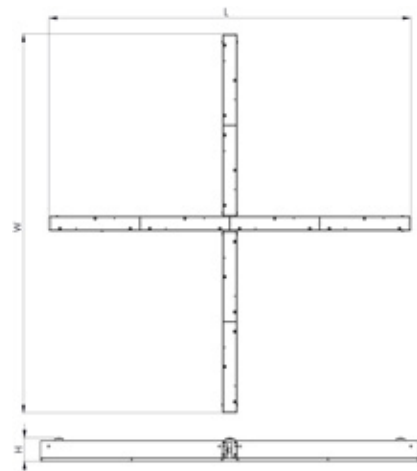

PRODUCT	LENGTH, mm	WIDTH, mm	HEIGHT, mm	LUMINAIRE OUTPUT*, lm	SYSTEM POWER*, W	SYSTEM EFFICACY*, lm/W	CRI	CCT*, K	WEIGHT, kg
Shop A LED1x7600 J419 T840 L75 LO1 L1 CORNER360	1185	1132	65	7593	41,8	182	80+	4000	4,9
Shop A LED1x10550 J420 T840 L75 LO2 L1 CORNER360	1185	1132	65	10520	60,0	175	80+	4000	4,9
Shop A LED1x11050 J421 T840 L75 LO3 L1 CORNER360	1185	1132	65	11046	58,1	190	80+	4000	4,9
Shop A LED1x13150 J422 T840 L75 LO4 L1 CORNER360	1185	1132	65	13134	70,3	187	80+	4000	4,9
Shop A LED1x15150 J423 T840 L75 LO5 L1 CORNER360	1185	1132	65	15108	82,4	183	80+	4000	4,9

*Tolerance range for optical and electrical data: ±10%. Values apply to an ambient temperature of 25°C. NORTHCLIFFE LIGHTING is constantly developing and improving its products. The right is reserved to change any product specifications without prior notification

Note - for versions: LO1, LO2 - only every second LED lights up

Note - plug is positioned at the longest end of the luminaire and socket is out at opposite end. If changes to be made please discuss project with your sales manager

AVAILABLE ACCESSORIES:



Product: Suspension MTG KIT SUSI
Description: Suspension wire set "I" type, 1.5m adjustable, 1pcs
**note - 2pcs MTG SUSI KIT for length up to 2000mm, 3pcs MTG SUSI KIT for lengths 2000 - 3000mm*



Product: CAP cable 3x0.75 2.0m clear
Description: Cable 3x0.75mm² for suspended luminaire up to 2.0 meters, transparent



Product: CAP cable clip D6.3mm SET clear
Description: Cable and suspension wire clip set, 4pcs. For cable diameter up to 6,3mm and wire diameter 1mm



Product: END CAP Shop A LED RAL9003
Description: End cap kit for Shop A LED luminaires, 1pcs (extra)



Product: BLANK Shop A LED L-BRANCH CORNER360 RAL9003
Description: Blank part kit for connecting luminaires in-line "H" shaped, 1pcsluminaires in-line 1134mm long, 1pcs



Product: CAP4, light grey/ white/ black
Description: Square decorative metal cap for hiding cable inlet with suspension wire attachment point, push-in terminals 3x1x1.5mm², light grey/ white/ black



Product: Power supply socket 1602/VCB-M-5 5x1.5-2.5mm²
Description: 5-pole socket (Stucchi - 1602/ VCB-M-5) for power supply, 1pcs
**note - please use power supply socket for first in-line luminaire connection to power source*

Product: CAP5, light grey/ white/ black
Description: Square decorative metal cap for hiding cable inlet with suspension wire attachment point, push-in terminals 5x1x1.5mm², light grey/ white/ black

OPTIONS AVAILABLE ON REQUEST:

LED	REFLECTOR AND OPTICS	LIGHT OUTPUT LEVELS	CONTROL GEAR	CONNECTION	COLOUR
T830	L30	LO1...5	DALI 2WIE5D ¹	L1	RAL
T840	L40x75			L2	
T930	L75			L3	
T940	L75W				
	L90W				
	L100				
	L2A25				

¹ With 2WIE5D option luminaire is throughwired with only one phase

L30

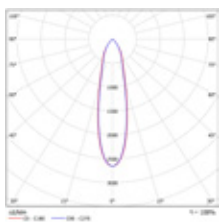

L40x75

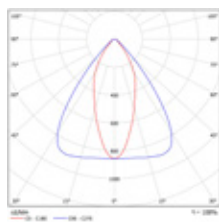

L75

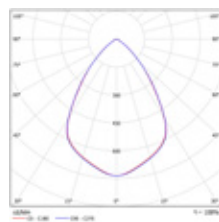

L75W

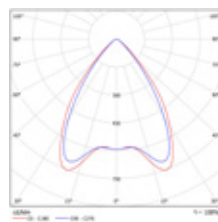

L90W

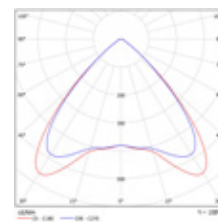

L100

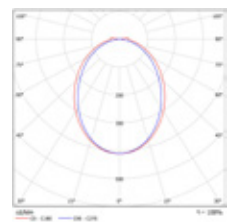

L2A25

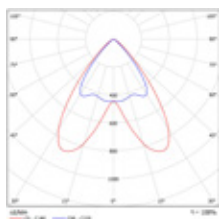

MALL LED

Continuous Line and Batten Luminaires



DESCRIPTION: **Suspended continuous line LED luminaire**
Light distribution type: direct
Optical system: lenses
Housing: steel
Colour: white, RAL9003S

GENERAL DATA: **Mains voltage:** 220-240V, 0/50-60Hz
LED lifetime, h: 100000/L80B10
SDCM: 3
Protection class IEC: I
Ingress protection code: IP20
Mechanical impact resistance: IK05
Operating temperature range, °C: ta 0...+40
(O... +35 for models E967, E989, E990, E994, E995)

INSTALLATION: Suspended (brackets and I-join kit included with each luminaire). Through wired, 5x1.5mm², two 5-pole plug and socket connectors

ENVIRONMENT: Indoor

APPLICATION: Retail, hall, public place



PRODUCT	LENGTH, mm	WIDTH, mm	HEIGHT, mm	LUMINAIRE OUTPUT*, lm	SYSTEM POWER*, W	SYSTEM EFFICACY*, lm/W	CRI	CCT*, K	WEIGHT, kg
Mall LED1x3300 E963 T840 L75 LO1 LL	1133	65	60	3300	18,4	179	80+	4000	3,2
Mall LED1x4350 E964 T840 L75 LO2 LL	1133	65	60	4301	24,8	173	80+	4000	3,2
Mall LED1x5300 E965 T840 L75 LO3 LL	1133	65	60	5260	30,6	172	80+	4000	3,2
Mall LED1x5550 G648 T840 L75 LO4 LL	1133	65	60	5523	29,7	186	80+	4000	3,2
Mall LED1x6600 E966 T840 L75 LO5 LL	1133	65	60	6567	35,5	185	80+	4000	3,2
Mall LED1x7600 E967 T840 L75 LO6 LL	1133	65	60	7554	41,6	181	80+	4000	3,2
Mall LED1x4150 E986 T840 L75 LO1 LL	1414	65	60	4125	23,0	179	80+	4000	3,7
Mall LED1x5400 E987 T840 L75 LO2 LL	1414	65	60	5376	30,3	177	80+	4000	3,7
Mall LED1x6600 E988 T840 L75 LO3 LL	1414	65	60	6575	37,9	174	80+	4000	3,7
Mall LED1x6950 G649 T840 L75 LO4 LL	1414	65	60	6903	37,1	186	80+	4000	3,7
Mall LED1x8250 E989 T840 L75 LO5 LL	1414	65	60	8209	44,4	185	80+	4000	3,7
Mall LED1x9450 E990 T840 L75 LO6 LL	1414	65	60	9443	52,1	181	80+	4000	3,7
Mall LED1x8300 E991 T840 L75 LO1 LL	2829	65	60	8251	44,5	185	80+	4000	6,9
Mall LED1x10800 E992 T840 L75 LO2 LL	2829	65	60	10753	59,4	181	80+	4000	6,9
Mall LED1x13150 E993 T840 L75 LO3 LL	2829	65	60	13150	75,0	175	80+	4000	6,9
Mall LED1x13850 G650 T840 L75 LO4 LL	2829	65	60	13808	71,9	192	80+	4000	6,9
Mall LED1x16450 E994 T840 L75 LO5 LL	2829	65	60	16418	87,9	187	80+	4000	6,9
Mall LED1x18900 E995 T840 L75 LO6 LL	2829	65	60	18884	103,0	183	80+	4000	6,9

*Tolerance range for optical and electrical data: ±10%. Values apply to an ambient temperature of 25°C. NORTHCLIFFE LIGHTING is constantly developing and improving its products. The right is reserved to change any product specifications without prior notification

Note - for versions: LO1, LO2, LO3 - only every second LED lights up

AVAILABLE ACCESSORIES:



Product: Suspension MTG KIT SUSI
Description: Suspension wire set "I" type, 1.5m adjustable, 1pcs
**note - 2pcs MTG SUSI KIT - for length up to 2000mm, 3pcs MTG SUSI KIT for lengths 2000-3000mm*



Product: END CAP - Mall LED RAL9003
Description: End cap kit for Mall LED luminaires, 1pcs
**note - use end caps for first and last in-line luminaires*

Product: BLANK Mall LED assembly L1133mm RAL9003
Description: Preassembled with trunking rail, blank part kit for connecting luminaires in-line, 1pcs

Product: BLANK Mall LED assembly L1414mm RAL9003
Description: Preassembled with trunking rail, blank part kit for connecting luminaires in-line, 1pcs

Product: BLANK Mall LED assembly L2829mm RAL9003
Description: Preassembled with trunking rail, blank part kit for connecting luminaires in-line, 1pcs

Product: BLANK Mall LED DALI assembly L1133mm RAL9003
Description: Preassembled with trunking rail, blank part kit for connecting luminaires in-line, 1pcs

Product: BLANK Mall LED DALI assembly L1414mm RAL9003
Description: Preassembled with trunking rail, blank part kit for connecting luminaires in-line, 1pcs

Product: BLANK Mall LED DALI assembly L2829mm RAL9003
Description: Preassembled with trunking rail, blank part kit for connecting luminaires in-line, 1pcs



Product: BLANK Mall LED track assembly L1414mm RAL9003
Description: Preassembled with trunking rail, blank with integrated track part kit for connecting luminaires in-line, 1pcs

Product: BLANK Mall LED track assembly L2829mm RAL9003
Description: Preassembled with trunking rail, blank with integrated track part kit for connecting luminaires in-line, 1pcs



Product: Power supply socket - Mall LED
Description: 7-pole socket for power supply, 1pcs
**note - use power supply socket for first in-line luminaire connection to power source*

OPTIONS AVAILABLE ON REQUEST:

LED	REFLECTOR AND OPTICS	CONTROL GEAR	EMERGENCY	COLOUR
T830	L30	DALI	EM3 ^{2 3}	RAL
T840	L40x75		EM3B ^{2 3}	
T930	L75		EM3A ^{2 3}	
T940	L75W		EM3D ^{2 3}	
	L90W			
	L1A18-L ¹			
	L1A18-R ¹			
	L2A25			

- 1 Please, specify direction for L1A18 optics
- 2 For EM option power supply L3 phase is used
- 3 Operating temperature range for Luminaires with EM option, °C: ta 0... +35

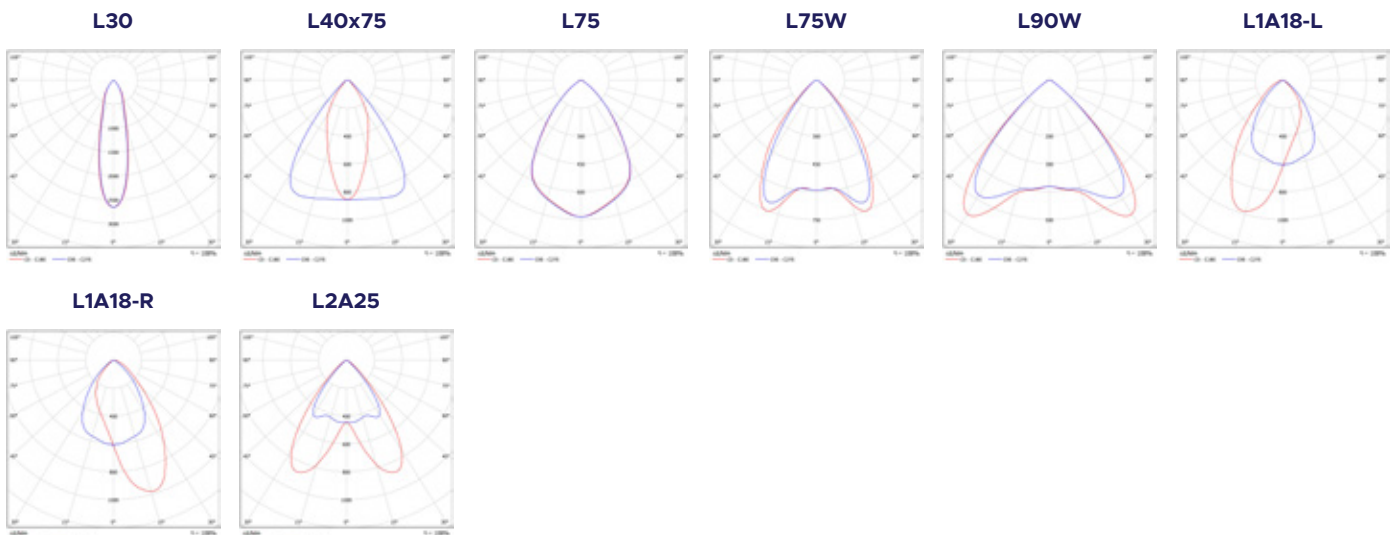





BORA Z LED

Continuous Line and Batten Luminaire



DESCRIPTION:	Mounted across cable trays batten LED luminaire Light distribution type: direct Optical system: lenses Housing: zinc coated steel Colour: light grey
GENERAL DATA:	Mains voltage: 220-240V, 0/50-60Hz LED lifetime, h: 100000/L80B10 SDCM: 3 Protection class IEC: I Ingress protection code: IP23 Mechanical impact resistance: IK07 Operating temperature range, °C: ta 0...+40
INSTALLATION:	Across cable trays (adjustable mounting brackets included). Push-in terminal, 5x2x2.5mm ²
ENVIRONMENT:	Indoor
APPLICATION:	Retail, hall, public place

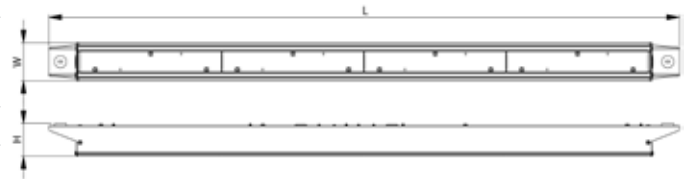

PRODUCT	LENGTH, mm	WIDTH, mm	HEIGHT, mm	LUMINAIRE OUTPUT*, lm	SYSTEM POWER*, W	SYSTEM EFFICACY*, lm/W	CRI	CCT*, K	WEIGHT, kg
Bora Z LED 1x5550 G634 T840 L75 HSB	1606-2446	75	80	5523	30,0	184	80+	4000	4,4
Bora Z LED 1x6600 G635 T840 L75 HSB	1606-2446	75	80	6567	35,9	183	80+	4000	4,4
Bora Z LED 1x7600 G636 T840 L75 HSB	1606-2446	75	80	7554	41,6	181	80+	4000	4,4
Bora Z LED 1x6950 G637 T840 L75 HSB	1906-2746	75	80	6904	36,7	188	80+	4000	4,6
Bora Z LED 1x8250 G638 T840 L75 HSB	1906-2746	75	80	8209	44,4	185	80+	4000	4,6
Bora Z LED 1x9450 G639 T840 L75 HSB	1906-2746	75	80	9442	51,5	183	80+	4000	4,6
Bora Z LED 1x11050 G640 T840 L75 HSB	2746-3586	75	80	11046	58,1	190	80+	4000	5,0
Bora Z LED 1x13150 G641 T840 L75 HSB	2746-3586	75	80	13134	70,3	187	80+	4000	5,0
Bora Z LED 1x15150 G642 T840 L75 HSB	2746-3586	75	80	15108	82,4	183	80+	4000	5,0
Bora Z LED 1x13850 G643 T840 L75 HSB	3260-4100	75	80	13808	72,7	190	80+	4000	5,4
Bora Z LED 1x16450 G644 T840 L75 HSB	3260-4100	75	80	16418	87,0	189	80+	4000	5,4
Bora Z LED 1x18900 G645 T840 L75 HSB	3260-4100	75	80	18884	101,9	185	80+	4000	5,4

*Tolerance range for optical and electrical data: ±10%. Values apply to an ambient temperature of 25°C. NORTHCLIFFE LIGHTING is constantly developing and improving its products. The right is reserved to change any product specifications without prior notification

OPTIONS AVAILABLE ON REQUEST:

LED	REFLECTOR AND OPTICS	CONTROL GEAR	EMERGENCY	CONNECTION	OTHER
T830	L30	DALI ¹	EM3 ²	L1	HSB
T840	L40x75		EM3B ²	L2	
T930	L75		EM3A ²	L3	
T940	L75W		EM3D ²	2G	
	L90W			WIE3-1.5m	
	L1A18			WIE3-3.0m	
	L2A25			WIE4-1.5m	
				WIE4-3.0m	
				WIE5-1.5m	
				WIE5-3.0m	
				WIE5D-1.5m	
				WIE5D-3.0m	

1 Minimum dimming level for models: G640; G641; G642; G643; G644; G645 is 1%. For other models - 10%
 2 Operating temperature range for Luminaires with EM option, °C: ta 0... +35

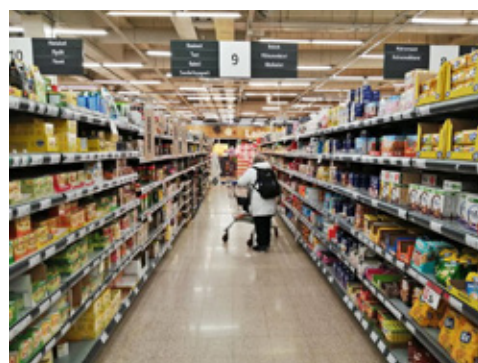
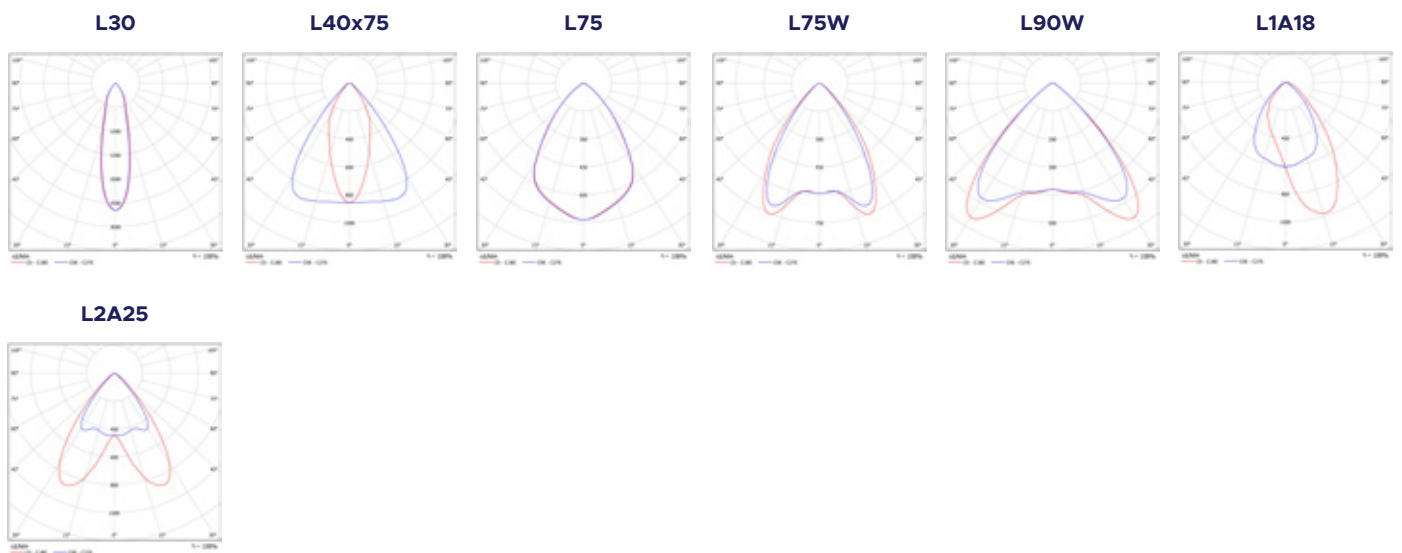

ATRIA LED

Continuous Line and Batten Luminaires

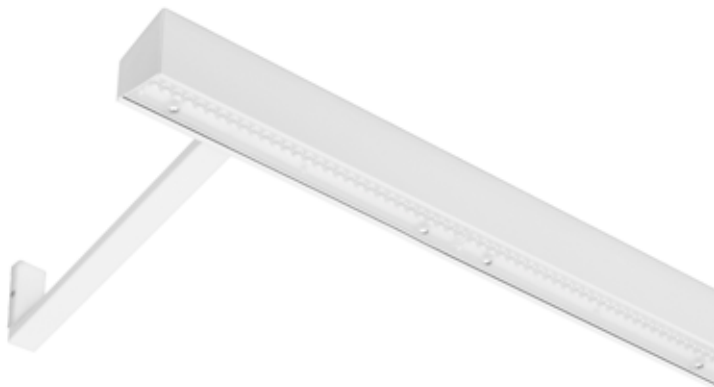

DESCRIPTION: **Suspended or wall-mounted LED batten luminaire for blackboard illumination**
Light distribution type: direct
Optical system: lenses
Housing: steel
Colour: white, RAL9003S

GENERAL DATA: **Mains voltage:** 220-240V, 0/50-60Hz
LED lifetime, h: 100000/L80B10
SDCM: 3
Protection class IEC: I
Ingress protection code: IP40
Mechanical impact resistance: IK05
Operating temperature range, °C: ta 0...+35

INSTALLATION: Suspended (wire, cable and cap to be ordered separately), on the wall (mounting brackets to be ordered separately). Push-in terminal, 3x2x2.5mm²

ENVIRONMENT: Indoor

APPLICATION: Education



PRODUCT	LENGTH, mm	WIDTH, mm	HEIGHT, mm	LUMINAIRE OUTPUT*, lm	SYSTEM POWER*, W	SYSTEM EFFICACY*, lm/W	CRI	CCT*, K	WEIGHT, kg
Atria LED 1x2750 G675 T840 L1A18	1140	60	68	2747	15,9	173	80+	4000	2,0
Atria LED 1x3800 G676 T840 L1A18	1140	60	68	3757	22,6	166	80+	4000	2,0
Atria LED 1x3450 G677 T840 L1A18	1420	60	68	3434	19,2	179	80+	4000	2,3
Atria LED 1x4700 G678 T840 L1A18	1420	60	68	4696	27,9	168	80+	4000	2,3

*Tolerance range for optical and electrical data: ±10%. Values apply to an ambient temperature of 25°C. NORTHCLIFFE LIGHTING is constantly developing and improving its products. The right is reserved to change any product specifications without prior notification

AVAILABLE ACCESSORIES:



Product: Suspension MTG KIT SUSI
Description: Suspension wire set "I" type, 1.5m adjustable, 1pcs
**note - 2pcs MTG SUSI KIT for 1 luminaire required*



Product: WALL MTG KIT Atria LED G range RAL9003 S
Description: Support bracket for luminaire installation onto the wall. Atria LED, 2pcs



Product: I-JOIN MTG KIT Atria LED G range RAL9003 S
Description: "I" type join kit for connecting luminaires in-line, 1pcs



Product: CAP cable 3x0.75 2.0m clear
Description: Cable 3x0.75mm² for suspended luminaire up to 2.0 meters, transparent



Product: CAP cable clip D6.3mm SET clear
Description: Cable and suspension wire clip set, 4pcs. For cable diameter up to 6,3mm and wire diameter 1mm



Product: CAP4, light grey/ white/ black
Description: Square decorative metal cap for hiding cable inlet with suspension wire attachment point, push-in terminals 3x1x1.5mm², light grey/ white/ black

Product: CAP5, light grey/ white/ black
Description: Square decorative metal cap for hiding cable inlet with suspension wire attachment point, push-in terminals 5x1x1.5mm², light grey/ white/ black

OPTIONS AVAILABLE ON REQUEST:

LED	CONTROL GEAR	EMERGENCY	CONNECTION	COLOUR
T830	DALI	EM3 ¹	CBF3-2.0m clear	RAL
T840		EM3B ¹	CBF3-3.0m clear	
		EM3A ¹	CBF5-2.0m clear	
		EM3D ¹	CBF5-3.0m clear	

1 Operating temperature range for Luminaires with EM option, °C: ta 0... +35

L1A18

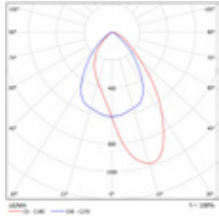

SHOP B LED

Continuous Line and Batten Luminaires



DESCRIPTION: Suspended asymmetrical LED batten luminaire
Light distribution type: direct
Optical system: lenses
Housing: steel
Colour: white, RAL9003S

GENERAL DATA: Mains voltage: 220-240V, 0/50-60Hz
LED lifetime, h: 100000/L80B10
SDCM: 3
Protection class IEC: I
Ingress protection code: IP20
Mechanical impact resistance: IK05
Operating temperature range, °C: ta 0...+35/+40

INSTALLATION: Suspended (wire, cable and cap to be ordered separately), on the wall (mounting brackets to be ordered separately). Push-in terminal, 3x2x2.5mm²

ENVIRONMENT: Indoor

APPLICATION: Retail, hall, public place



PRODUCT	LENGTH, mm	WIDTH, mm	HEIGHT, mm	LUMINAIRE OUTPUT*, lm	SYSTEM POWER*, W	SYSTEM EFFICACY*, lm/W	CRI	CCT*, K	WEIGHT, kg
Shop B LED1x3800 J424 T840 L1A18 LO1	1134	47	86	3757	21,8	172	80+	4000	3,7
Shop B LED1x5250 J425 T840 L1A18 LO2	1134	47	86	5205	31,7	164	80+	4000	3,7
Shop B LED1x5500 J426 T840 L1A18 LO3	1134	47	86	5465	30,0	182	80+	4000	3,7
Shop B LED1x6500 J427 T840 L1A18 LO4	1134	47	86	6499	35,9	181	80+	4000	3,7
Shop B LED1x7500 J428 T840 L1A18 LO5	1134	47	86	7475	41,6	180	80+	4000	3,7
Shop B LED1x4700 J429 T840 L1A18 LO1	1415	47	86	4696	27,0	174	80+	4000	4,1
Shop B LED1x6550 J430 T840 L1A18 LO2	1415	47	86	6507	38,7	168	80+	4000	4,1
Shop B LED1x6850 J431 T840 L1A18 LO3	1415	47	86	6832	36,7	186	80+	4000	4,1
Shop B LED1x8150 J432 T840 L1A18 LO4	1415	47	86	8123	44,4	183	80+	4000	4,1
Shop B LED1x9350 J433 T840 L1A18 LO5	1415	47	86	9344	51,5	181	80+	4000	4,1

*Tolerance range for optical and electrical data: ±10%. Values apply to an ambient temperature of 25°C. NORTHCLIFFE LIGHTING is constantly developing and improving its products. The right is reserved to change any product specifications without prior notification

AVAILABLE ACCESSORIES:



Product: Suspension MTG KIT SUSI
Description: Suspension wire set "I" type, 1.5m adjustable, 1pcs
**note - 2pcs MTG SUSI KIT for 1 luminaire required*



Product: WALL MTG KIT Shop B LED RAL9003S
Description: Support bracket for luminaire installation onto wall. 2pcs



Product: I-Join Shop A LED
Description: I-Join element for connecting luminaires in-line, 1pcs (extra)



Product: CAP cable 3x0.75 2.0m clear
Description: Cable 3x0.75mm² for suspended luminaire up to 2.0 meters, transparent



Product: CAP4, light grey/ white/ black
Description: Square decorative metal cap for hiding cable inlet with suspension wire attachment point, push-in terminals 3x1x1.5mm², light grey/ white/ black



Product: CAP cable clip D6.3mm SET clear
Description: Cable and suspension wire clip set, 4pcs. For cable diameter up to 6,3mm and wire diameter 1mm

Product: CAP5, light grey/ white/ black
Description: Square decorative metal cap for hiding cable inlet with suspension wire attachment point, push-in terminals 5x1x1.5mm², light grey/ white/ black

OPTIONS AVAILABLE ON REQUEST:

LED	CONTROL GEAR	EMERGENCY	CONNECTION	COLOUR
T830	DALI	EM3 ¹	CBF3-2.0m clear	RAL
T840		EM3B ¹	CBF3-3.0m clear	
		EM3A ¹	CBF5-2.0m clear	
		EM3D ¹	CBF5-3.0m clear	

¹ Operating temperature range for Luminaires with EM option, °C: ta 0... +35

L1A18

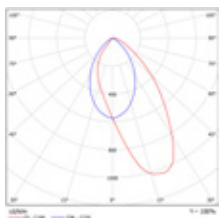

Zodiaq LED

Continuous Line and Batten Luminaires



DESCRIPTION: **Surface mounted industrial LED luminaire**
Light distribution type: direct
Optical system: lenses
Housing: galvanized steel
Colour: RAW galvanized steel

GENERAL DATA: **Mains voltage:** 220-240V, 0/50-60Hz
LED lifetime, h: 50000/L80B10
SDCM: 3
Protection class IEC: I
Ingress protection code: IP23
Mechanical impact resistance: IK07
Operating temperature range, °C: ta 10...+35

INSTALLATION: On the ceiling or wall, or suspended. Through wired, 5x1.5mm², two push-in terminals, 5x2x2.5mm²

ENVIRONMENT: Indoor

APPLICATION: Retail, industry, warehouse, hall, public place

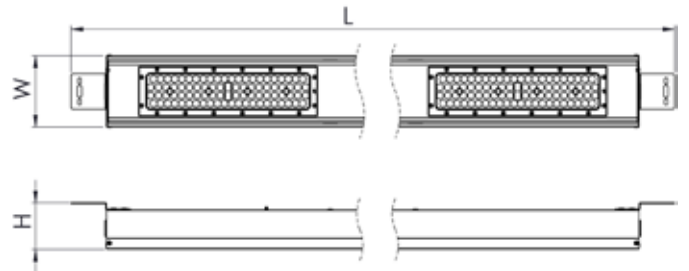

PRODUCT	LENGTH, mm	WIDTH, mm	HEIGHT, mm	LUMINAIRE OUTPUT*, lm	SYSTEM POWER*, W	SYSTEM EFFICACY*, lm/W	CRI	CCT*, K	WEIGHT, kg
Zodiaq LED1x11400 J778 T840 L90x90 3LIN 2G	1600	102	66	11391	68,7	166	80+	4000	2,7
Zodiaq LED1x13550 J779 T840 L90x90 3LIN 2G	1600	102	66	13547	83,4	162	80+	4000	2,7
Zodiaq LED1x15550 J780 T840 L90x90 3LIN 2G	1600	102	66	15517	97,2	160	80+	4000	2,7
Zodiaq LED1x16800 J781 T840 L90x90 3LIN 2G	1600	102	66	16782	103,1	163	80+	4000	2,7

*Tolerance range for optical and electrical data: ±10%. Values apply to an ambient temperature of 25°C. NORTHCLIFFE LIGHTING is constantly developing and improving its products. The right is reserved to change any product specifications without prior notification

AVAILABLE ACCESSORIES:



Product: Sensor HBEAIR D16/4-16m white
Description: Integrated smart sensor for high ceiling (up to 16m) with wireless communication and grouping possibilities for lighting control
**note - HBEAIR accesorie is only compatible with the HBEAIR-S option*

OPTIONS AVAILABLE ON REQUEST:

LED	REFLECTOR AND OPTICS	CONTROL GEAR	SENSORS	EMERGENCY	CONNECTION
T830	L30x65	DALI	HBPIR7m-M ⁵	EM3 ²	L1
T840	L40	HBEAIRB-M ^{1 2 3 4}	HBPIR12m-M ^{6 7}	EM3B ²	L2
	L60	HBEAIRB-S ^{1 3}		EM3A ²	L3
	L75	COR		EM3D ²	2WIE5 ⁸
	L90x90	COR1min			2x LCS 75/5
	L120	COR30min			

- 1 Max system size 1x HBEAIR-M + 3x HBEAIR-S
- 2 The impact protection rating of the HBEAIR-M option is IK05
- 3 Max wire length from HBEAIR-M to last HBEAIR-S - 11m
- 4 For more effective master luminaire installation it is recommended to choose HAIR-S option and sensor accessory combination
- 5 Max switching load up to 2A
- 6 Max switching load up to 4A
- 7 Luminaires with HBPIR options are suitable to be installed as a standalone or an end luminaire in line
- 8 With 2WIE5 option luminaire ingress protection rating is IP20

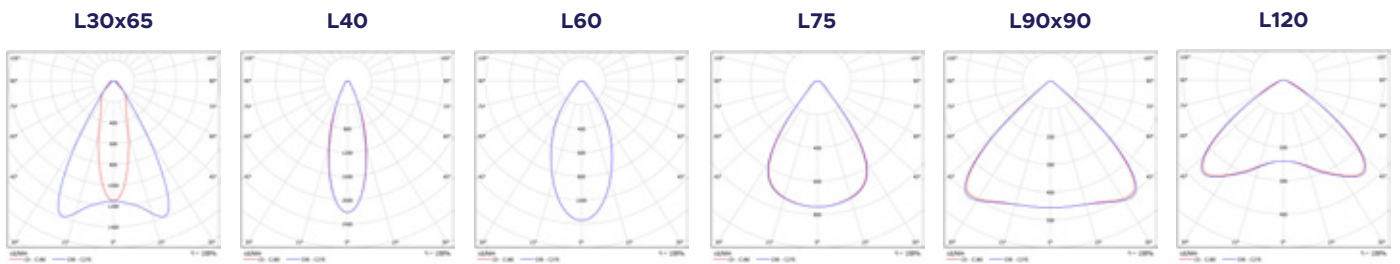

DIFFUSER AND WALL LUMINAIRES



PUPIS P LED

Diffuser and Wall Luminaires



DESCRIPTION: **Surface mounted plastic LED luminaire**
Light distribution type: direct
Optical system: opal polycarbonate diffuser, impact resistant
Housing: polycarbonate
Colour: white

GENERAL DATA: **Mains voltage:** 220-240V, 50-60Hz
LED lifetime, h: 40000/L70B50
SDCM: 5
Protection class IEC: II
Ingress protection code: IP65
Mechanical impact resistance: IK08
Operating temperature range, °C: ta -15..+35

INSTALLATION: On the ceiling or walls. Screw terminal, 2x1.5mm²

ENVIRONMENT: Indoor

APPLICATION: Office, education, corridor, staircase, healthcare, bathroom, public place

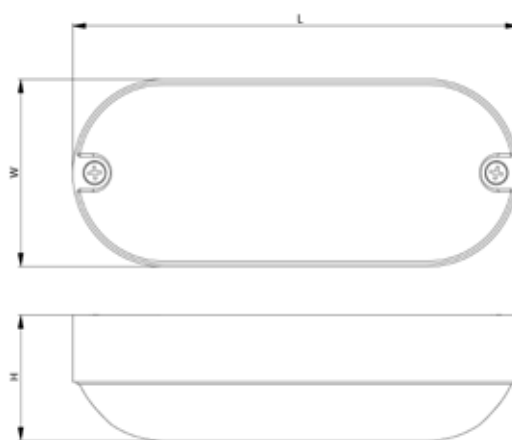

PRODUCT	LENGTH, mm	WIDTH, mm	HEIGHT, mm	LUMINAIRE OUTPUT*, lm	SYSTEM POWER*, W	SYSTEM EFFICACY*, lm/W	CRI	CCT*, K	WEIGHT, kg
Pupis P LED1x500 D541 T730 OP	171	71	45	500	5,0	100	70+	3000	0,2

*Tolerance range for optical and electrical data: ±10%. Values apply to an ambient temperature of 25°C. NORTHCLIFFE LIGHTING is constantly developing and improving its products. The right is reserved to change any product specifications without prior notification

OP

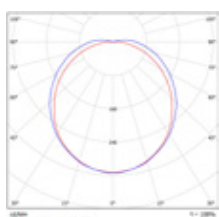

CETUS P LED

Diffuser and Wall Luminaires



DESCRIPTION: **Surface mounted plastic LED luminaire**
Light distribution type: direct
Optical system: opal polycarbonate diffuser, impact resistant
Housing: polycarbonate
Colour: white

GENERAL DATA: **Mains voltage:** 220-240V, 50-60Hz
LED lifetime, h: 40000/L70B50
SDCM: 5
Protection class IEC: II
Ingress protection code: IP65
Mechanical impact resistance: IK08
Operating temperature range, °C: ta -15...+35

INSTALLATION: On the ceiling or walls. Screw terminal, 2x1.5mm²

ENVIRONMENT: Indoor

APPLICATION: Office, education, corridor, staircase, healthcare, bathroom, public place

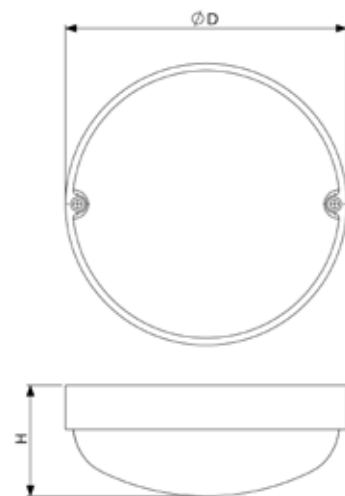

PRODUCT	DIAMETER, mm	HEIGHT, mm	LUMINAIRE OUTPUT*, lm	SYSTEM POWER*, W	SYSTEM EFFICACY*, lm/W	CRI	CCT*, K	WEIGHT, kg
Cetus P LED1x1200 D671 T830 OP	160	63	1080	12,0	90	80+	3000	0,2

*Tolerance range for optical and electrical data: ±10%. Values apply to an ambient temperature of 25°C. NORTHCLIFFE LIGHTING is constantly developing and improving its products. The right is reserved to change any product specifications without prior notification

OP

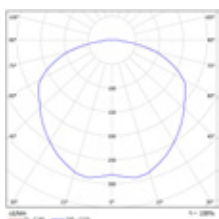

PAVO P LED

Diffuser and Wall Luminaires



DESCRIPTION:	Surface mounted LED luminaire Light distribution type: direct Optical system: opal PMMA diffuser Housing: steel Colour: white, RAL9003
GENERAL DATA:	Mains voltage: 220-240V, 50-60Hz LED lifetime, h: 50000/L70B50, basic version: 40000/L70B50 SDCM: 5 Protection class IEC: I Ingress protection code: IP44 Mechanical impact resistance: IK02 Operating temperature range, °C: ta -15..+35
INSTALLATION:	On the ceiling or wall. Screw terminal, 3x1.5mm ²
ENVIRONMENT:	Indoor
APPLICATION:	Office, education, hotel, corridor, staircase, healthcare, bathroom, public place

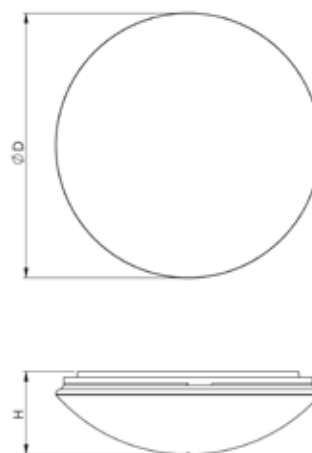

PRODUCT	DIAMETER, mm	HEIGHT, mm	LUMINAIRE OUTPUT*, lm	SYSTEM POWER*, W	SYSTEM EFFICACY*, lm/W	CRI	CCT*, K	WEIGHT, kg
Pavo P LED1x1300 G600 T840	280	90	1293	14,0	92	80+	4000	0,5
Pavo P LED1x2000 G345 T840	360	105	2032	20,0	102	80+	4000	0,7
Basic version								
Pavo P LED1x1100 D515 T840	280	90	1080	12,0	90	80+	4000	0,5
Pavo P LED1x1600 D516 T840	360	105	1700	18,0	94	80+	4000	0,7
Pavo P LED1x2000 D517 T840	410	115	2200	22,0	100	80+	4000	0,9
Pavo P LED1x3000 D518 T840	410	115	3200	32,0	100	80+	4000	0,9
Pavo P LED1x4200 D995 T840	500	140	4164	40,0	104	80+	4000	1,5
Pavo P LED1x1100 D515 T840 MW	280	90	1080	12,0	90	80+	4000	0,5
Pavo P LED1x1600 D516 T840 MW	360	105	1700	18,0	94	80+	4000	0,7
Pavo P LED1x1100 D515 T840 EM3	280	90	1080	12,0	90	80+	4000	0,6
Pavo P LED1x1600 D516 T840 EM3	360	105	1700	18,0	94	80+	4000	0,9

*Tolerance range for optical and electrical data: ±10%. Values apply to an ambient temperature of 25°C. NORTHCLIFFE LIGHTING is constantly developing and improving its products. The right is reserved to change any product specifications without prior notification

OPTIONS AVAILABLE ON REQUEST:

LED	CONTROL GEAR	SENSORS	EMERGENCY
T830	DALI	MW	EM3 ¹
T840	COR	MWRFMD	EM3B ¹
	COR1min	MWRFM	EM3A ¹
	COR30min	MWRFSD	EM3D ¹
		MWRFS	

¹ Operating temperature range for Luminaires with EM option, °C: ta 0... +35

STANDARD

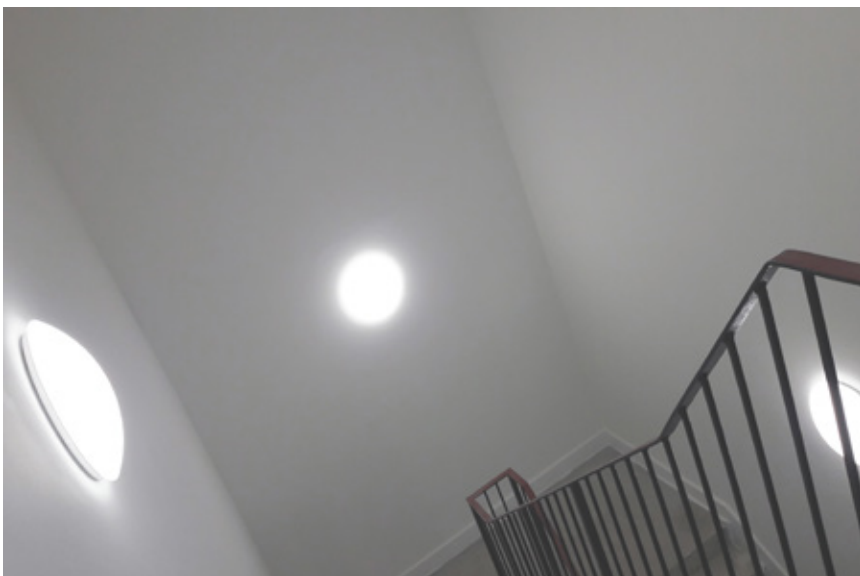
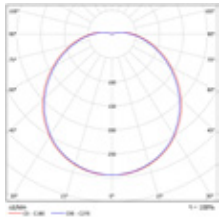

INDUS P LED

Diffuser and Wall Luminaires



- DESCRIPTION:** Surface mounted plastic LED luminaire
Light distribution type: direct
Optical system: opal acrylic diffuser, UV resistant
Housing: thermoplastic
Colour: white; dark grey; black
-
- GENERAL DATA:** Mains voltage: 220-240V, 50-60Hz
LED lifetime, h: 50000/L80B10
SDCM: 3
Protection class IEC: II
Ingress protection code: IP65
Mechanical impact resistance: IK08
Operating temperature range, °C: ta -15...+35 (from 0°C with EM3)
-
- INSTALLATION:** On the ceiling or wall. Push-in terminal, 2x2x2.5mm² (Screw terminal, 2x1.5mm² for E27 version)
-
- ENVIRONMENT:** Indoor/outdoor with roof
-
- APPLICATION:** Office, education, hotel, corridor, staircase, healthcare, bathroom, public place, parking area

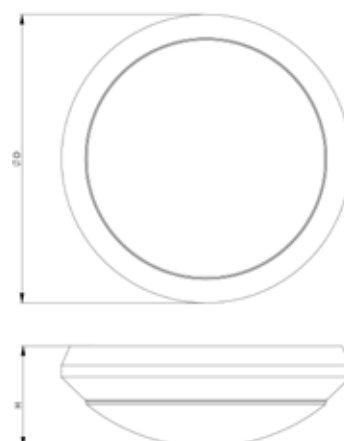

PRODUCT	DIAMETER, mm	HEIGHT, mm	LUMINAIRE OUTPUT*, lm	SYSTEM POWER*, W	SYSTEM EFFICACY*, lm/W	CRI	CCT*, K	WEIGHT, kg
Indus P 1E27 T80 1G	295	100						1,0
Indus P LED1x1200 D501 T840 1G	295	100	1102	9,3	119	80+	4000	1,1
Indus P LED1x1650 D502 T840 1G	295	100	1539	13,5	114	80+	4000	1,1
Indus P 1E27 T80 LOUVER	295	100						1,0
Indus P LED1x1200 D501 T840 LOUVER	295	100	648	9,3	70	80+	4000	1,1
Indus P LED1x1650 D502 T840 LOUVER	295	100	906	13,5	67	80+	4000	1,1
Indus P 1E27 T80 DGREY	295	100						1,0
Indus P LED1x1200 D501 T840 DGREY	295	100	1102	9,3	119	80+	4000	1,1
Indus P LED1x1650 D502 T840 DGREY	295	100	1539	13,5	114	80+	4000	1,1
Indus P 1E27 T80 LOUVER DGREY	295	100						1,0
Indus P LED1x1200 D501 T840 LOUVER DGREY	295	100	648	9,3	70	80+	4000	1,1
Indus P LED1x1650 D502 T840 LOUVER DGREY	295	100	906	13,5	67	80+	4000	1,1

*Tolerance range for optical and electrical data: ±10%. Values apply to an ambient temperature of 25°C. NORTHCLIFFE LIGHTING is constantly developing and improving its products. The right is reserved to change any product specifications without prior notification

OPTIONS AVAILABLE ON REQUEST:

LED	COVERS	CONTROL GEAR	SENSORS	EMERGENCY
T830	LOUVER	DALI ¹	MW	EM3 ²
T840			MWRFMD	EM3B ²
			MWRFM	EM3A ²
			MWRFSD	EM3D ²
			MWRFS	

- 1 For this model DALI option is not compatible with SWITCHDIM functionality
- 2 Operating temperature range for Luminaires with EM option, °C: ta 0... +35

STANDARD

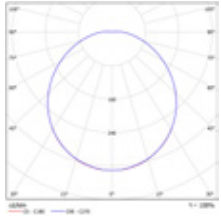

LOUVER

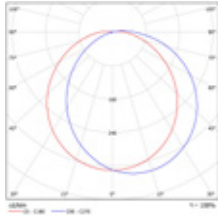

HEZE P LED

Diffuser and Wall Luminaires



DESCRIPTION: **Surface mounted plastic LED luminaire**
Light distribution type: direct
Optical system: opal acrylic diffuser, UV resistant
Housing: thermoplastic
Colour: white; dark grey

GENERAL DATA: **Mains voltage:** 220-240V, 0/50-60Hz
LED lifetime, h: 50000/L80B10
SDCM: 3
Protection class IEC: II
Ingress protection code: IP65
Mechanical impact resistance: IK08
Operating temperature range, °C: ta -15...+35 (from 0°C with EM3)

INSTALLATION: On the ceiling or wall. Push-in terminal, 2x2x2.5mm²
 (Screw terminal, 2x1.5mm² for E27 version)

ENVIRONMENT: Indoor/outdoor with roof

APPLICATION: Office, education, hotel, corridor, staircase, healthcare, bathroom, public place, parking area

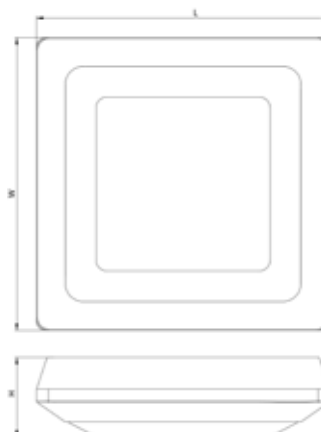

PRODUCT	LENGTH, mm	WIDTH, mm	HEIGHT, mm	LUMINAIRE OUTPUT*, lm	SYSTEM POWER*, W	SYSTEM EFFICACY*, lm/W	CRI	CCT*, K	WEIGHT, kg
Heze P 1E27 Z70	295	295	90						1,4
Heze P LED1x1200 D960 T840 1G	295	295	90	1167	10,1	115	80+	4000	1,7
Heze P LED1x1650 D961 T840 1G	295	295	90	1631	14,7	111	80+	4000	1,7
Heze P 1E27 Z70 LOUVER	295	295	90						1,4
Heze P LED1x1200 D960 T840 LOUVER	295	295	90	715	10,1	71	80+	4000	1,7
Heze P LED1x1650 D961 T840 LOUVER	295	295	90	999	14,7	68	80+	4000	1,7
Heze P 1E27 Z70 DGREY	295	295	90						1,4
Heze P LED1x1200 D960 T840 DGREY	295	295	90	1167	10,1	115	80+	4000	1,7
Heze P LED1x1650 D961 T840 DGREY	295	295	90	1631	14,7	111	80+	4000	1,7
Heze P 1E27 Z70 LOUVER DGREY	295	295	90						1,4
Heze P LED1x1200 D960 T840 LOUVER DGREY	295	295	90	715	10,1	71	80+	4000	1,7
Heze P LED1x1650 D961 T840 LOUVER DGREY	295	295	90	999	14,7	68	80+	4000	1,7

*Tolerance range for optical and electrical data: ±10%. Values apply to an ambient temperature of 25°C. NORTHCLIFFE LIGHTING is constantly developing and improving its products. The right is reserved to change any product specifications without prior notification

OPTIONS AVAILABLE ON REQUEST:

LED	COVERS	CONTROL GEAR	SENSORS	EMERGENCY
T830	LOUVER	DALI	MW	EM3 ¹
T840			MWRFMD	EM3B ¹
			MWRFM	EM3A ¹
			MWRFSD	EM3D ¹
			MWRFS	

¹ Operating temperature range for Luminaires with EM option, °C: ta 0... +35

OP

LOUVER

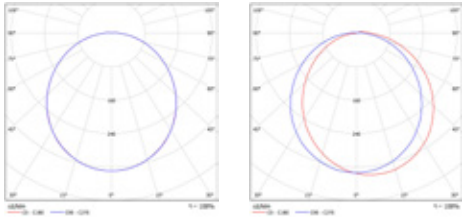

STORM P LED

Diffuser and Wall Luminaires

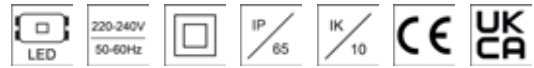

DESCRIPTION: Surface mounted plastic LED luminaire with adjustable output
Light distribution type: direct
Optical system: opal polycarbonate diffuser, UV stable, impact resistant
Housing: polycarbonate
Colour: white; black

GENERAL DATA: **Mains voltage:** 220-240V, 50-60Hz
LED lifetime, h: 50000/L70B50
SDCM: 5
Protection class IEC: II
Ingress protection code: IP65
Mechanical impact resistance: IK10
Operating temperature range, °C: ta -20...+40

INSTALLATION: On the ceiling or wall. Push-in terminal, 2x2x2.5mm²

ENVIRONMENT: Indoor/Outdoor with roof

APPLICATION: Office, education, corridor, staircase, public place

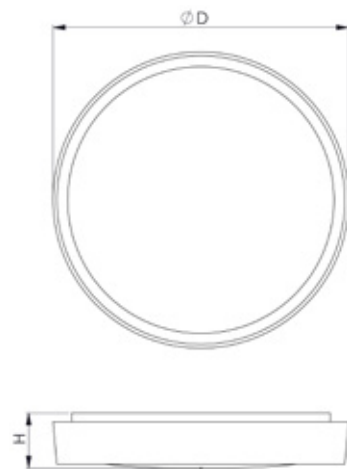

PRODUCT	DIAMETER, mm	HEIGHT, mm	LUMINAIRE OUTPUT*, lm	SYSTEM POWER*, W	SYSTEM EFFICACY*, lm/W	CRI	CCT*, K	WEIGHT, kg
Storm P LED1x1000/1500/2000/2550 J584 T830/40	352	68	1000/1500/2000/2550	10/14/18/22	95/100/100/102	80+	3000/4000	1,4
Storm P LED1x1000/1500/2000/2550 J584 T830/40 BLACK	352	68	1000/1500/2000/2550	10/14/18/22	95/100/100/102	80+	3000/4000	1,4

*Tolerance range for optical and electrical data: ±10%. Values apply to an ambient temperature of 25°C. NORTHCLIFFE LIGHTING is constantly developing and improving its products. The right is reserved to change any product specifications without prior notification

OPTIONS AVAILABLE ON REQUEST:

LED	CONTROL GEAR	SENSORS	EMERGENCY
T830	DALI ¹	MW	EM3 ²
T840	COR ¹		EM3B ²
			EM3A ²
			EM3D ²
			EM3Atmin-25

STANDARD

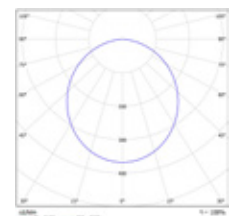

1 For DALI, COR options, indicate what output is required
 2 Operating temperature range for Luminaires with EM option, C: ta 0... +35

POLLUX P LED

Diffuser and Wall Luminaires



DESCRIPTION: Surface mounted plastic LED luminaire
Light distribution type: direct
Optical system: opal polycarbonate diffuser
Housing: polycarbonate
Colour: white, RAL9003

GENERAL DATA: Mains voltage: 230V, 0/50-60Hz
LED lifetime, h: 50000/L90B10
SDCM: 3
Protection class IEC: I
Ingress protection code: IP54
Mechanical impact resistance: IK10
Protection symbol: D
Glow wire test, °C: 850
Operating temperature range, °C: ta -15...+35

INSTALLATION: On the ceiling or wall. Push-in terminal, 3x2x2.5mm²

ENVIRONMENT: Indoor

APPLICATION: Office, education, hotel, corridor, staircase, healthcare, bathroom, public place

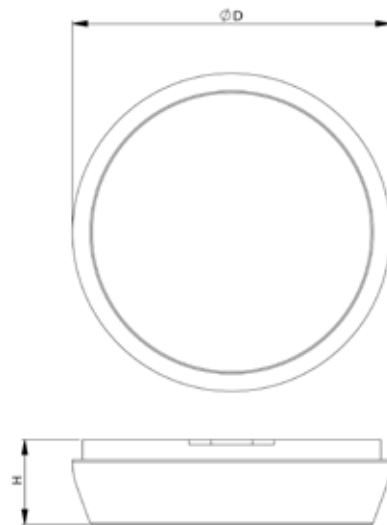

PRODUCT	DIAMETER, mm	HEIGHT, mm	LUMINAIRE OUTPUT*, lm	SYSTEM POWER*, W	SYSTEM EFFICACY*, lm/W	CRI	CCT*, K	WEIGHT, kg
Pollux P LED1x1200 G620 T840 OP	300	85	1220	10,0	122	80	4000	1,1
Pollux P LED1x1500 G621 T840 OP	300	85	1500	12,0	125	80	4000	1,1
Pollux P LED1x2050 G622 T840 OP	300	85	1990	17,0	117	80	4000	1,1
Pollux P LED1x2950 G623 T840 OP	300	85	2780	24,0	116	80	4000	1,1

*Tolerance range for optical and electrical data: ±10%. Values apply to an ambient temperature of 25°C. NORTHCLIFFE LIGHTING is constantly developing and improving its products. The right is reserved to change any product specifications without prior notification

OPTIONS AVAILABLE ON REQUEST:

LED	CONTROL GEAR	SENSORS	EMERGENCY
T830	DALI	MW	EM3 ¹
T840			EM3B ¹
			EM3A ¹
			EM3D ¹

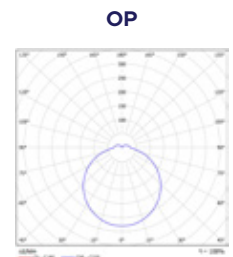

¹ Operating temperature range for Luminaires with EM option, °C: ta 0... +35

DORADO P LED

Diffuser and Wall Luminaires

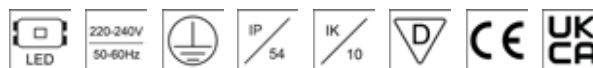

DESCRIPTION: Surface mounted plastic LED luminaire
Light distribution type: direct
Optical system: opal polycarbonate diffuser, impact resistant
Housing: polycarbonate
Colour: white, RAL9003

GENERAL DATA: Mains voltage: 230V, 0/50-60Hz
 LED lifetime, h: 50000/L90B10
 SDCM: 3
 Protection class IEC: I
 Ingress protection code: IP54
 Mechanical impact resistance: IK10
 Protection symbol: D
 Glow wire test, °C: 850
 Operating temperature range, °C: ta -15...+35

INSTALLATION: On the ceiling or wall. Push-in terminal, 3x2x2.5mm²

ENVIRONMENT: Indoor

APPLICATION: Office, education, hotel, corridor, staircase, healthcare, bathroom, public place



PRODUCT	LENGTH, mm	WIDTH, mm	HEIGHT, mm	LUMINAIRE OUTPUT*, lm	SYSTEM POWER*, W	SYSTEM EFFICACY*, lm/W	CRI	CCT*, K	WEIGHT, kg
Dorado P LED1x1200 G624 T840 OP	330	330	85	1220	10,0	122	80	4000	1,5
Dorado P LED1x1500 G625 T840 OP	330	330	85	1500	12,0	125	80	4000	1,5
Dorado P LED1x2050 G626 T840 OP	330	330	85	1990	17,0	117	80	4000	1,5
Dorado P LED1x2900 G627 T840 OP	330	330	85	2780	24,0	116	80	4000	1,5

*Tolerance range for optical and electrical data: ±10%. Values apply to an ambient temperature of 25°C. NORTHCLIFFE LIGHTING is constantly developing and improving its products. The right is reserved to change any product specifications without prior notification

OPTIONS AVAILABLE ON REQUEST:

LED	CONTROL GEAR	EMERGENCY
T830	DALI	EM3B ¹
T840		

¹ Operating temperature range for Luminaires with EM option, °C: ta 0... +35

OP

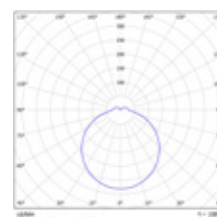

CARINA P LED

Diffuser and Wall Luminaires



DESCRIPTION: **Surface mounted LED luminaire**
Light distribution type: direct
Optical system: translucent micro-linear polycarbonate diffuser
Housing: steel
Colour: white, RAL9003

GENERAL DATA: **Mains voltage:** 220-240V, 0/50-60Hz
LED lifetime, h: 100000/L80B10, basic version: 50000/L80B10
SDCM: 3
Protection class IEC: I (II optional)
Ingress protection code: IP54
Mechanical impact resistance: IK05
Protection symbol: D
Glow wire test, °C: 850
Operating temperature range, °C: ta -15...+35 (from 0°C with EM3), basic version: ta -15...+35

INSTALLATION: On the ceiling or wall. Push-in terminal, 5x2x2.5mm²

ENVIRONMENT: Indoor

APPLICATION: Office, education, hotel, corridor, staircase, healthcare, bathroom, public place



PRODUCT	LENGTH, mm	WIDTH, mm	HEIGHT, mm	LUMINAIRE OUTPUT*, lm	SYSTEM POWER*, W	SYSTEM EFFICACY*, lm/W	CRI	CCT*, K	WEIGHT, kg
Carina P LED1x1500 G444 T840 MPRZ	615	97	72	1475	10,3	144	80+	4000	1,5
Carina P LED1x2050 G445 T840 MPRZ	615	97	72	2017	13,9	145	80+	4000	1,5
Carina P LED1x2700 G446 T840 MPRZ	615	97	72	2675	18,9	142	80+	4000	1,5
Carina P LED1x3050 G447 T840 MPRZ	615	97	72	3031	20,5	148	80+	4000	1,5
Carina P LED1x2750 G448 T840 MPRZ	1175	97	72	2689	18,3	147	80+	4000	2,3
Carina P LED1x3550 G449 T840 MPRZ	1175	97	72	3507	22,9	153	80+	4000	2,3
Carina P LED1x4600 G450 T840 MPRZ	1175	97	72	4570	30,5	150	80+	4000	2,3
Carina P LED1x5400 G451 T840 MPRZ	1175	97	72	5351	35,2	152	80+	4000	2,3
Carina P LED1x6100 G452 T840 MPRZ	1175	97	72	6062	39,2	155	80+	4000	2,3
Carina P LED1x3400 G453 T840 MPRZ	1455	97	72	3362	22,3	151	80+	4000	2,8
Carina P LED1x4400 G454 T840 MPRZ	1455	97	72	4383	28,6	153	80+	4000	2,8
Carina P LED1x5750 G455 T840 MPRZ	1455	97	72	5713	38,1	150	80+	4000	2,8
Carina P LED1x6700 G456 T840 MPRZ	1455	97	72	6688	42,6	157	80+	4000	2,8
Carina P LED1x7600 G457 T840 MPRZ	1455	97	72	7577	48,4	156	80+	4000	2,8

PRODUCT Basic version	LENGTH, mm	WIDTH, mm	HEIGHT, mm	LUMINAIRE OUTPUT*, lm	SYSTEM POWER*, W	SYSTEM EFFICACY*, lm/W	CRI	CCT*, K	WEIGHT, kg
Carina P LED1x2150 H113 T840 MPRZ 1G 2Gr	615	97	72	2142	14,8	145	80+	4000	1,5
Carina P LED1x2550 H196 T840 MPRZ	615	97	72	2525	17,8	142	80+	4000	1,5
Carina P LED1x3550 H114 T840 MPRZ 1G 2Gr	1175	97	72	3534	25,2	140	80+	4000	2,3
Carina P LED1x5100 H115 T840 MPRZ 1G 2Gr	1175	97	72	5051	35,5	142	80+	4000	2,3
Carina P LED1x4450 H200 T840 MPRZ	1455	97	72	4418	31,5	140	80+	4000	2,8
Carina P LED1x6350 H116 T840 MPRZ 1G 2Gr	1455	97	72	6313	44,3	143	80+	4000	2,8

*Tolerance range for optical and electrical data: ±10%. Values apply to an ambient temperature of 25°C. NORTHCLIFFE LIGHTING is constantly developing and improving its products. The right is reserved to change any product specifications without prior notification

AVAILABLE ACCESSORIES:



Product: Suspension MTG KIT SUSI
Description: Suspension wire set "I" type, 1.5m adjustable, 1pcs
**note - 2pcs MTG SUSI KIT for 1 luminaire required*



Product: CAP cable 3x0.75 2.0m clear
Description: Cable 3x0.75mm² for suspended luminaire up to 2.0 meters, transparent



Product: CAP cable clip D6.3mm SET clear
Description: Cable and suspension wire clip set, 4pcs. For cable diameter up to 6,3mm and wire diameter 1mm

OPTIONS AVAILABLE ON REQUEST:

LED	CONTROL GEAR	SENSORS	EMERGENCY	OTHER	PROTECTION	COLOUR
T830	DALI	MW ¹	EM3 ²	2Gr	II	RAL
T840	COR	MWRFM ¹	EM3B ^{2 3}			
	COR1min	MWRFM ¹	EM3A ^{2 3}			
	COR30min	MWRFS ¹	EM3D ^{2 3}			
		MWRFS ¹				

1 All MW options are incompatible with options EM3B, EM3D, EM3A for 1175mm version
 2 Operating temperature range for Luminaires with EM option, °C: ta 0... +35
 3 EM3B/A/D options not available for models: H113; H196

MPRZ

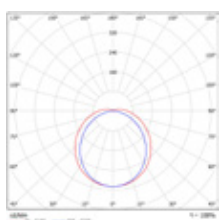



CARINA LED

Diffuser and Wall Luminaires



DESCRIPTION: **Surface mounted LED luminaire**
Light distribution type: direct
Optical system: opal micro-linear polycarbonate diffuser
Housing: steel
Colour: white, RAL9003

GENERAL DATA: **Mains voltage:** 220-240V, 50-60Hz / 220-240V, 0/50-60Hz
LED lifetime, h: 100000/L80B10; basic version: 50000/L80B10
SDCM: 3
Protection class IEC: I
Ingress protection code: IP44
Mechanical impact resistance: IK04
Operating temperature range, °C: ta -10...+40

INSTALLATION: On ceiling or wall. Push-in terminal, 3x2x2.5mm²

ENVIRONMENT: Indoor

APPLICATION: Office, education, corridor, staircase, public place

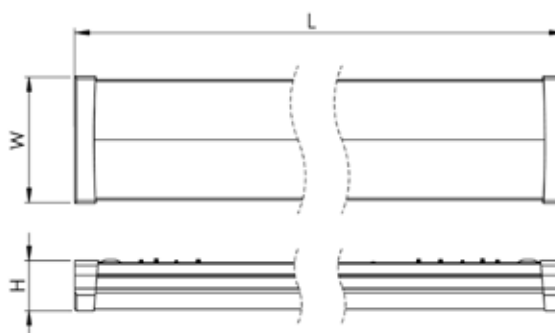

PRODUCT	LENGTH, mm	WIDTH, mm	HEIGHT, mm	LUMINAIRE OUTPUT*, lm	SYSTEM POWER*, W	SYSTEM EFFICACY*, lm/W	CRI	CCT*, K	WEIGHT, kg
Carina LED2x950 G938 T840 OP LT80	622	146	60	1897	12,7	149	80+	4000	1,9
Carina LED2x1150 G939 T840 OP LT80	622	146	60	2255	15,2	148	80+	4000	1,9
Carina LED2x1300 G940 T840 OP LT80	622	146	60	2594	17,3	150	80+	4000	1,9
Carina LED2x1650 G941 T840 OP LT80	622	146	60	3262	23,5	139	80+	4000	1,9
Carina LED2x1900 G942 T840 OP LT80	1182	146	60	3794	24,4	155	80+	4000	3,0
Carina LED2x2300 G943 T840 OP LT80	1182	146	60	4511	29,1	155	80+	4000	3,0
Carina LED2x2600 G944 T840 OP LT80	1182	146	60	5189	34,1	152	80+	4000	3,0
Carina LED2x3300 G945 T840 OP LT80	1182	146	60	6523	44,3	147	80+	4000	3,0
Carina LED2x2400 G946 T840 OP LT80	1462	146	60	4742	29,8	159	80+	4000	3,8
Carina LED2x2850 G947 T840 OP LT80	1462	146	60	5638	36,0	157	80+	4000	3,8
Carina LED2x3250 G948 T840 OP LT80	1462	146	60	6486	41,8	155	80+	4000	3,8
Carina LED2x4100 G949 T840 OP LT80	1462	146	60	8154	54,2	150	80+	4000	3,8
Basic version									
Carina LED2x1700 H220 T840 OP LT80	1182	146	60	3336	23,7	141	80+	4000	3,0
Carina LED2x2000 H221 T840 OP LT80	1182	146	60	3968	28,5	139	80+	4000	3,0
Carina LED2x2300 H222 T840 OP LT80	1182	146	60	4546	33,6	135	80+	4000	3,0
Carina LED2x2100 H223 T840 OP LT80	1462	146	60	4171	29,7	140	80+	4000	3,8
Carina LED2x2500 H224 T840 OP LT80	1462	146	60	4960	35,6	139	80+	4000	3,8
Carina LED2x2850 H225 T840 OP LT80	1462	146	60	5683	41,9	136	80+	4000	3,8

*Tolerance range for optical and electrical data: ±10%. Values apply to an ambient temperature of 25°C. NORTHCLIFFE LIGHTING is constantly developing and improving its products. The right is reserved to change any product specifications without prior notification

OPTIONS AVAILABLE ON REQUEST:

LED	REFLECTOR AND OPTICS	CONTROL GEAR	SENSORS	EMERGENCY	CONNECTION	OTHER	PROTECTION	COLOUR
T830	DPRZ	DALI	MW ¹	EM3 ^{2 3}	5TB	2Gr	II	RAL ⁵
T840		COR	MWRFMD*	EM3B* ^{2 3}	1LIN ⁴			
		COR1min	MWRFM*	EM3A* ^{2 3}	3LIN ⁴			
		COR30min	MWRFSD*	EM3D* ^{2 3}	1LIN2.5 ⁴			
			MWRFS*		3LIN2.5 ⁴			
					2G			

- 1 MW option is not applicable for models: G938...G941
- 2 All EM options are not compatible for models: G938...G941
- 3 Operating temperature range for Luminaires with EM option, °C: ta 0... +35
- 4 LIN options applicable for models longer than 800mm, for shorter models 5TB option
- 5 Thermoplastic end covers are only available in white, light grey and black colours
- * Options not applicable for H series models

OP LT80

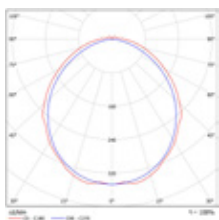

DOCTOR P LED

Diffuser and Wall Luminaires



DESCRIPTION: **Surface mounted plastic LED luminaire**
Light distribution type: direct
Optical system: opal polycarbonate diffuser, impact resistant
Housing: polycarbonate
Colour: white

GENERAL DATA: **Mains voltage:** 220-240V, 0/50-60Hz
LED lifetime, h: 100000/L80B10
SDCM: 3
Protection class IEC: I
Ingress protection code: IP54
Mechanical impact resistance: IK08
Operating temperature range, °C: ta -15...+35

INSTALLATION: On the ceiling or wall. Push-in terminal, 3x2x2.5mm²

ENVIRONMENT: Indoor

APPLICATION: Office, education, corridor, staircase, healthcare, public place



PRODUCT	LENGTH, mm	WIDTH, mm	HEIGHT, mm	LUMINAIRE OUTPUT*, lm	SYSTEM POWER*, W	SYSTEM EFFICACY*, lm/W	CRI	CCT*, K	WEIGHT, kg
Doctor P LED1x2650 G467 T840 OP LT80	1160	110	85	2594	17,1	152	80+	4000	1,9
Doctor P LED1x3400 G468 T840 OP LT80	1160	110	85	3383	21,6	157	80+	4000	1,9
Doctor P LED1x4450 G469 T840 OP LT80	1160	110	85	4409	29,1	151	80+	4000	1,9
Doctor P LED2x2650 G470 T840 OP LT80	1160	160	85	5217	33,3	157	80+	4000	2,6
Doctor P LED2x3300 G471 T840 OP LT80	1160	160	85	6563	43,3	152	80+	4000	2,6
Doctor P LED2x3900 G472 T840 OP LT80	1160	160	85	7783	50,1	155	80+	4000	2,6

*Tolerance range for optical and electrical data: ±10%. Values apply to an ambient temperature of 25°C. NORTHCLIFFE LIGHTING is constantly developing and improving its products. The right is reserved to change any product specifications without prior notification

OPTIONS AVAILABLE ON REQUEST:

LED	CONTROL GEAR	SENSORS	EMERGENCY	CONNECTION
T830	DALI	MW	EM3	5TB
T840			EM3B	

OP LT80

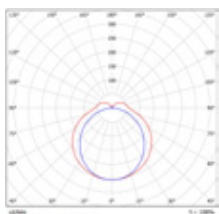

MIRA LED

Diffuser and Wall Luminaires



DESCRIPTION: **Surface mounted mirror LED luminaire**
Light distribution type: direct
Optical system: opal polycarbonate diffuser
Housing: aluminium
Colour: white

GENERAL DATA: **Mains voltage:** 220-240V, 50-60Hz
LED lifetime, h: 30000/L70B50
SDCM: 5
Protection class IEC: II (I with built-in socket)
Ingress protection code: IP44
Mechanical impact resistance: IK04
Operating temperature range, °C: ta 0...+35

INSTALLATION: On the wall (mounting brackets included).
 Screw terminal, 2x1.5mm² (3x1.5mm² with built-in socket)

ENVIRONMENT: Indoor

APPLICATION: Hotel, bathroom, healthcare

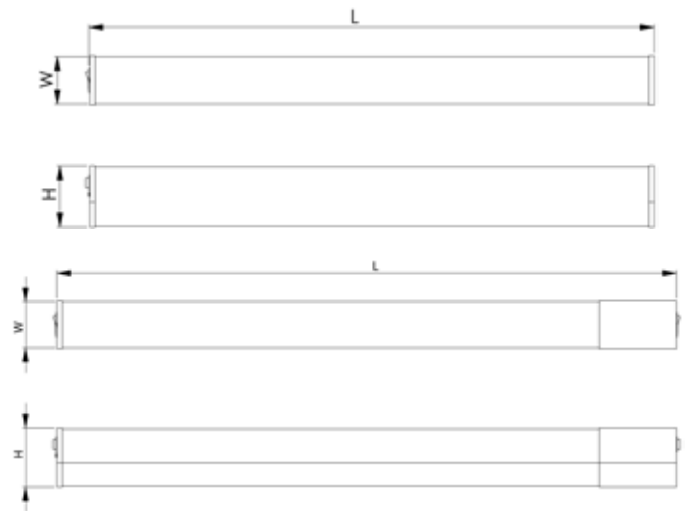

PRODUCT	LENGTH, mm	WIDTH, mm	HEIGHT, mm	LUMINAIRE OUTPUT*, lm	SYSTEM POWER*, W	SYSTEM EFFICACY*, lm/W	CRI	CCT*, K	WEIGHT, kg
Mira LED1x1400 D552 T830 OP	600	53	65	1400	15,0	93	80+	3000	0,6
Mira LED1x1400 D553 T830 OP SOCS44	682	53	65	1400	15,0	93	80+	3000	0,8

*Tolerance range for optical and electrical data: ±10%. Values apply to an ambient temperature of 25°C. NORTHCLIFFE LIGHTING is constantly developing and improving its products. The right is reserved to change any product specifications without prior notification

OPTIONS AVAILABLE ON REQUEST:

CONNECTION

SOCS44

OP

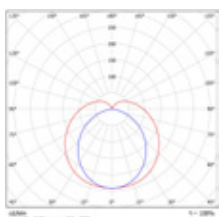

LUPI LED

Diffuser and Wall Luminaires



DESCRIPTION: **Wall-mounted decorative LED luminaire**
Light distribution type: direct/indirect
Optical system: opal polycarbonate diffuser
Housing: aluminium
Colour: light grey, RAL9006S; white, RAL9003S; black, RAL9005S

GENERAL DATA: **Mains voltage:** 220-240V, 0/50-60Hz
LED lifetime, h: 50000/L80B10
SDCM: 3
Protection class IEC: I
Ingress protection code: IP44
Mechanical impact resistance: IK05
Operating temperature range, °C: ta -15...+35

INSTALLATION: On the wall. Push-in terminal, 3x2x2.5mm²

ENVIRONMENT: Indoor

APPLICATION: Hotel, bathroom



PRODUCT	LENGTH, mm	WIDTH, mm	HEIGHT, mm	LUMINAIRE OUTPUT*, lm	SYSTEM POWER*, W	SYSTEM EFFICACY*, lm/W	CRI	CCT*, K	WEIGHT, kg
Lupi LED1x800/800 D847 T840 OP LG3	580	85	75	1445	12,8	112	80+	4000	2,0
Lupi LED1x1100/1100 D848 T840 OP LG3	580	85	75	1968	18,0	110	80+	4000	2,0
Lupi LED1x1500/1500 D849 T840 OP LG3	580	85	75	2705	25,6	105	80+	4000	2,0
Lupi LED1x1150/1050 J434 T840 OP LG3	860	85	75	2167	19,1	113	80+	4000	2,5
Lupi LED1x1550/1450 J435 T840 OP LG3	860	85	75	2952	27,0	109	80+	4000	2,5
Lupi LED1x2150/1950 J436 T840 OP LG3	860	85	75	4058	38,6	105	80+	4000	2,5
Lupi LED1x1550/1400 J437 T840 OP LG3	1140	85	75	2888	25,1	115	80+	4000	3,0
Lupi LED1x2100/1900 J438 T840 OP LG3	1140	85	75	3936	31,8	124	80+	4000	3,0
Lupi LED1x2850/2600 J439 T840 OP LG3	1140	85	75	5411	50,9	106	80+	4000	3,0

*Tolerance range for optical and electrical data: ±10%. Values apply to an ambient temperature of 25°C. NORTHCLIFFE LIGHTING is constantly developing and improving its products. The right is reserved to change any product specifications without prior notification

OPTIONS AVAILABLE ON REQUEST:

CONTROL GEAR	COLOUR
DALI	RAL

OP

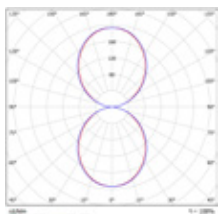

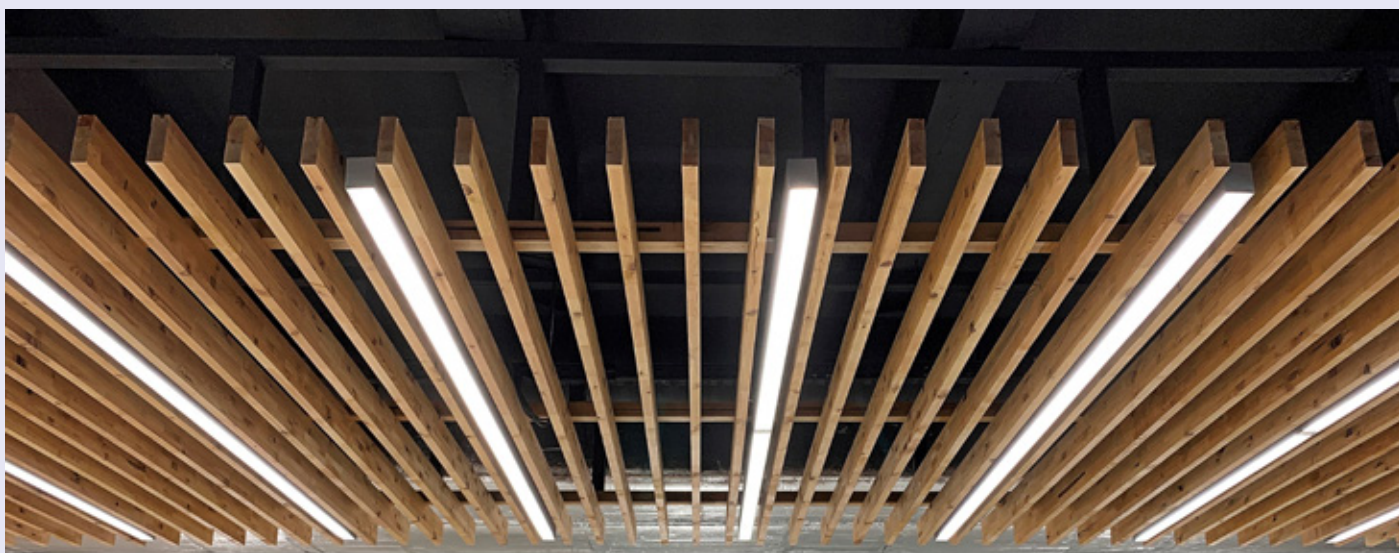

WATERPROOF AND CLEANROOM LUMINAIRES



BARAT LED

Waterproof and Cleanroom Luminaires



DESCRIPTION: **Surface mounted or suspended waterproof LED luminaire**
Light distribution type: direct
Optical system: opal polycarbonate diffuser, UV stable, impact resistant
Housing: polycarbonate
Colour: light grey

GENERAL DATA: **Mains voltage:** 220-240V, 0/50-60Hz, basic version: 220-240V, 50-60Hz
LED lifetime, h: 100000/L80B10, basic version: 50000/L80B10
SDCM: 3
Protection class IEC: I (II optional)
Ingress protection code: IP66
Mechanical impact resistance: IK10
Protection symbol: D
Glow wire test, °C: 850
Operating temperature range, °C: ta -20...+35/ +40, basic version: ta -20...+35

INSTALLATION: On the ceiling or wall (mounting brackets included), or suspended (hooks included). Push-in terminal, 5x2x2.5mm²

ENVIRONMENT: Indoor/outdoor with roof

APPLICATION: Industry, warehouse, hall, sports, public place, parking area, transport terminal, parking area

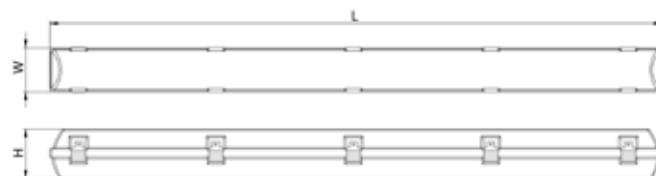

PRODUCT	LENGTH, mm	WIDTH, mm	HEIGHT, mm	LUMINAIRE OUTPUT*, lm	SYSTEM POWER*, W	SYSTEM EFFICACY*, lm/W	CRI	CCT*, K	WEIGHT, kg
Barat LED1x1600 G237 T840 PC/PC OP LT80	662	96	111	1561	10,0	156	80+	4000	1,3
Barat LED1x2150 G238 T840 PC/PC OP LT80	662	96	111	2136	13,9	154	80+	4000	1,3
Barat LED1x2850 G239 T840 PC/PC OP LT80	662	96	111	2833	17,2	165	80+	4000	1,3
Barat LED2x2150 G240 T840 PC/PC OP LT80	662	146	111	4271	25,6	167	80+	4000	1,8
Barat LED1x2850 G241 T840 PC/PC OP LT80	1272	96	111	2847	17,3	165	80+	4000	2,1
Barat LED1x3750 G242 T840 PC/PC OP LT80	1272	96	111	3713	21,9	170	80+	4000	2,1
Barat LED1x4600 G243 T840 PC/PC OP LT80	1272	96	111	4556	27,5	166	80+	4000	2,1
Barat LED1x5400 G244 T840 PC/PC OP LT80	1272	96	111	5398	33,0	164	80+	4000	2,1
Barat LED1x7150 G245 T840 PC/PC OP LT80	1272	96	111	7122	43,3	165	80+	4000	2,1
Barat LED1x9650 G246 T840 PC/PC OP LT80	1272	96	111	9628	57,5	167	80+	4000	2,1
Barat LED2x5700 G247 T840 PC/PC OP LT80	1272	146	111	11331	65,9	172	80+	4000	2,8
Barat LED1x4500 G248 T840 PC/PC OP LT80	1572	96	111	4498	27,8	162	80+	4000	2,6
Barat LED1x5700 G249 T840 PC/PC OP LT80	1572	96	111	5695	34,0	167	80+	4000	2,6
Barat LED1x6750 G250 T840 PC/PC OP LT80	1572	96	111	6747	40,8	165	80+	4000	2,6
Barat LED1x8950 G251 T840 PC/PC OP LT80	1572	96	111	8903	54,1	165	80+	4000	2,6
Barat LED1x12050 G252 T840 PC/PC OP LT80	1572	96	111	12035	71,1	169	80+	4000	2,6
Barat LED2x7100 G253 T840 PC/PC OP LT80	1572	146	111	14164	82,4	172	80+	4000	3,3

PRODUCT Basic version	LENGTH, mm	WIDTH, mm	HEIGHT, mm	LUMINAIRE OUTPUT*, lm	SYSTEM POWER*, W	SYSTEM EFFICACY*, lm/W	CRI	CCT*, K	WEIGHT, kg
Barat LED1x2300 H117 T840 PC/PC OP LT80 1G	662	96	111	2268	14,8	153	80+	4000	1,3
Barat LED1x2700 H118 T840 PC/PC OP LT80 1G	662	96	111	2674	17,8	150	80+	4000	1,3
Barat LED1x3750 H119 T840 PC/PC OP LT80 1G	1272	96	111	3742	25,2	148	80+	4000	2,1
Barat LED1x5350 H120 T840 PC/PC OP LT80 1G	1272	96	111	5348	35,5	151	80+	4000	2,1
Barat LED1x4700 H211 T840 PC/PC OP LT80	1572	96	111	4678	31,5	149	80+	4000	2,1
Barat LED1x6700 H122 T840 PC/PC OP LT80 1G	1572	96	111	6685	44,4	151	80+	4000	2,6
Barat LED1x8700 H124 T840 PC/PC OP LT80	1572	96	111	8666	59,7	145	80+	4000	2,6

*Tolerance range for optical and electrical data: ±10%. Values apply to an ambient temperature of 25°C. NORTHCLIFFE LIGHTING is constantly developing and improving its products. The right is reserved to change any product specifications without prior notification

AVAILABLE ACCESSORIES:



Product: Suspension MTG KIT - Barat/Proof/Nord LED 1.5m
Description: Suspension kit for Barat/Proof/Nord LED luminaires, 1.5 meter, 2pcs

Product: Suspension MTG KIT - Barat/Proof/Nord LED 3.0m
Description: Suspension kit for Barat/Proof/Nord LED luminaires, 3.0 meter, 2pcs

OPTIONS AVAILABLE ON REQUEST:

LED	MATERIAL	CONTROL GEAR	SENSORS	EMERGENCY	CONNECTION	OTHER	PROTECTION
T830	ABS/PMMA ¹	DALI ²	MW	EMGB ⁵	1LIN ⁷	IC	II
T840		COR	MWRFM ³	EM3B ⁵	2LIN ⁷		
		COR1min	MWRFM ³	EM3A ^{5 6}	3LIN ⁷		
		COR30min	MWRFS ³	EM3A ^{5 6}	1LIN2.5 ⁷		
			MWRFS ³	EM3D ^{5 6}	2LIN2.5 ⁷		
			HBPIR15m-M ⁴		3LIN2.5 ⁷		
			DALI HBPIRD15m-M ⁴		2G		
			KRBLT HBPIR15m-M ⁴		C3		
			DALI KRBLT HBPIRD15m-M ⁴				

1 Luminaires with ABS/PMMA options are equipped with plastic cable glands

2 For DALI LIN option wires are 2x0.5mm²

3 All MWRFM and MWRFS options not applicable for models: G237, G238, G239, H117, H118

4 Luminaires with integrated HBPIR15m-M, DALI HBPIRD15m-M, KRBLT HBPIR15m-M, DALI KRBLT HBPIRD15m-M sensors protection degrees are IP65 and IK05

5 Operating temperature range for Luminaires with EM option, °C: ta 0... +35

6 Options EM3A, EM3A_{min25} and EM3D not applicable for models: H117, H118

7 LIN options applicable for models longer than 800mm, for shorter models 5 pole terminal block included as standard

OP LT80

OP LT80 (2xversion)

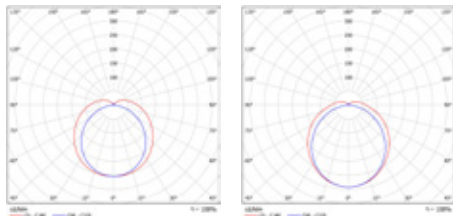



NORD LED

Waterproof and Cleanroom Luminaires



DESCRIPTION: **Surface mounted waterproof LED luminaire for use in extreme temperature -40 to +50°C environments**
Light distribution type: direct
Optical system: opal polycarbonate diffuser, UV stable, impact resistant
Housing: polycarbonate
Colour: light grey

GENERAL DATA: **Mains voltage:** 220-240V, 0/50-60Hz
LED lifetime, h: 100000/L80B10
SDCM: 3
Protection class IEC: I
Ingress protection code: IP66
Mechanical impact resistance: IK10
Protection symbol: D
Glow wire test, °C: 850
Operating temperature range, °C: ta -40...+50

INSTALLATION: On the ceiling or wall (mounting brackets included), or suspended (hooks included). Push-in terminal, 5x2x2.5mm²

ENVIRONMENT: Indoor/outdoor with roof

APPLICATION: Industry, cold store, bakery, heating plant, glass factory

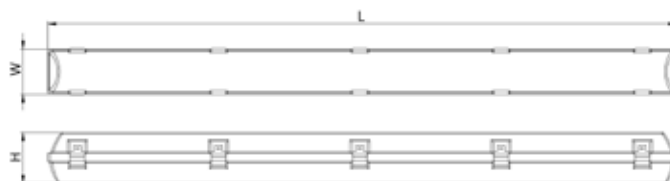

PRODUCT	LENGTH, mm	WIDTH, mm	HEIGHT, mm	LUMINAIRE OUTPUT*, lm	SYSTEM POWER*, W	SYSTEM EFFICACY*, lm/W	CRI	CCT*, K	WEIGHT, kg
Nord LED1x4600 G473 T840 OP LT80 IC ta-40+50C	1272	96	111	4559	26,8	170	80+	4000	2,1
Nord LED1x5700 G474 T840 OP LT80 IC ta-40+50C	1272	96	111	5665	34,4	165	80+	4000	2,1
Nord LED1x6800 G475 T840 OP LT80 IC ta-40+50C	1272	96	111	6769	39,6	171	80+	4000	2,1
Nord LED2x4600 G476 T840 OP LT80 IC ta-40+50C	1272	146	111	9118	52,5	174	80+	4000	2,8
Nord LED1x4250 G477 T840 OP LT80 IC ta-40+50C	1572	96	111	4205	24,1	174	80+	4000	2,6
Nord LED1x5200 G478 T840 OP LT80 IC ta-40+50C	1572	96	111	5178	30,4	171	80+	4000	2,6
Nord LED1x7150 G479 T840 OP LT80 IC ta-40+50C	1572	96	111	7082	42,6	166	80+	4000	2,6
Nord LED1x8500 G480 T840 OP LT80 IC ta-40+50C	1572	96	111	8461	49,0	173	80+	4000	2,6
Nord LED2x5200 G481 T840 OP LT80 IC ta-40+50C	1572	146	111	10356	58,7	177	80+	4000	3,3

*Tolerance range for optical and electrical data: ±10%. Values apply to an ambient temperature of 25°C. NORTHCLIFFE LIGHTING is constantly developing and improving its products. The right is reserved to change any product specifications without prior notification

AVAILABLE ACCESSORIES:



Product: Suspension MTG KIT - Barat/Proof/Nord LED 1.5m
Description: Suspension kit for Barat/Proof/Nord LED luminaires, 1.5 meter, 2pcs

Product: Suspension MTG KIT - Barat/Proof/Nord LED 3.0m
Description: Suspension kit for Barat/Proof/Nord LED luminaires, 3.0 meter, 2pcs

OPTIONS AVAILABLE ON REQUEST:

LED	REFLECTOR AND OPTICS	CONTROL GEAR	CONNECTION
T830	OP LT80	DALI ¹	1LIN
T840		COR	3LIN
		COR1min	1LIN2.5
		COR30min	3LIN2.5
			2G

¹ For DALI LIN option wires are 2x0.5mm²

OP LT80

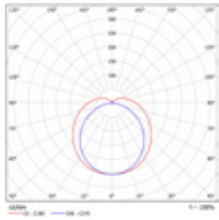

OP LT80 (2xversion)

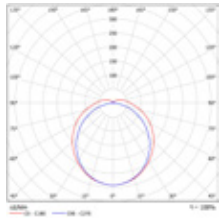

PROOF LED

Waterproof and Cleanroom Luminaires



DESCRIPTION: **Surface mounted waterproof LED luminaire for use in food industry and aggressive environments**
Light distribution type: direct
Optical system: opal acrylic diffuser, good chemical resistance
Housing: thermoplastic, good chemical resistance
Colour: light grey

GENERAL DATA: **Mains voltage:** 220-240V, 0/50-60Hz
LED lifetime, h: 100000/L80B10
SDCM: 3
Protection class IEC: I (II optional)
Ingress protection code: IP66
Mechanical impact resistance: IK06
Protection symbol: D
Glow wire test, °C: 650
Operating temperature range, °C: ta -20...+35/ +40

INSTALLATION: On the ceiling or wall (mounting brackets included), or suspended (hooks included). Push-in terminal, 5x2x2.5mm²

ENVIRONMENT: Indoor

APPLICATION: Industry, food processing area, warehouse, hall, agriculture

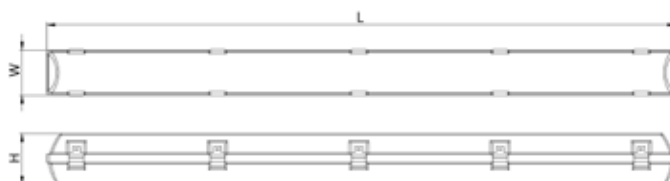

PRODUCT	LENGTH, mm	WIDTH, mm	HEIGHT, mm	LUMINAIRE OUTPUT*, lm	SYSTEM POWER*, W	SYSTEM EFFICACY*, lm/W	CRI	CCT*, K	WEIGHT, kg
Proof LED1x1600 G482 T840 OP LT80	662	96	111	1561	10,0	156	80+	4000	1,3
Proof LED1x2150 G483 T840 OP LT80	662	96	111	2136	13,9	154	80+	4000	1,3
Proof LED1x2850 G484 T840 OP LT80	662	96	111	2833	18,2	155	80+	4000	1,3
Proof LED2x2150 G485 T840 OP LT80	662	146	111	4271	25,9	165	80+	4000	1,8
Proof LED1x2850 G486 T840 OP LT80	1272	96	111	2847	18,5	154	80+	4000	2,1
Proof LED1x3750 G487 T840 OP LT80	1272	96	111	3713	22,3	166	80+	4000	2,1
Proof LED1x4600 G488 T840 OP LT80	1272	96	111	4556	27,8	164	80+	4000	2,1
Proof LED1x5400 G489 T840 OP LT80	1272	96	111	5370	33,7	159	80+	4000	2,1
Proof LED1x7150 G490 T840 OP LT80	1272	96	111	7160	43,7	164	80+	4000	2,1
Proof LED1x9650 G491 T840 OP LT80	1272	96	111	9577	57,3	167	80+	4000	2,1
Proof LED2x5700 G492 T840 OP LT80	1272	146	111	11272	65,7	171	80+	4000	2,8
Proof LED1x4500 G493 T840 OP LT80	1572	96	111	4498	28,7	157	80+	4000	2,6
Proof LED1x5700 G494 T840 OP LT80	1572	96	111	5695	34,4	166	80+	4000	2,6
Proof LED1x6750 G495 T840 OP LT80	1572	96	111	6712	41,1	163	80+	4000	2,6
Proof LED1x9000 G496 T840 OP LT80	1572	96	111	8949	54,8	163	80+	4000	2,6
Proof LED1x12050 G497 T840 OP LT80	1572	96	111	11972	70,9	169	80+	4000	2,6
Proof LED2x7100 G498 T840 OP LT80	1572	146	111	14090	82,2	171	80+	4000	3,3

*Tolerance range for optical and electrical data: ±10%. Values apply to an ambient temperature of 25°C. NORTHCLIFFE LIGHTING is constantly developing and improving its products. The right is reserved to change any product specifications without prior notification

AVAILABLE ACCESSORIES:



Product: Suspension MTG KIT - Barat/Proof/Nord LED 1.5m
Description: Suspension kit for Barat/Proof/Nord LED luminaires, 1.5 meter, 2pcs

Product: Suspension MTG KIT - Barat/Proof/Nord LED 3.0m
Description: Suspension kit for Barat/Proof/Nord LED luminaires, 3.0 meter, 2pcs

OPTIONS AVAILABLE ON REQUEST:

LED	CONTROL GEAR	SENSORS	EMERGENCY	CONNECTION	OTHER	PROTECTION
T830	DALI ¹	MW	EM3 ²	1LIN ⁴	IC	II
T840	COR	MWRFM	EM3B ^{2 3}	3LIN ⁴		
	COR1min	MWRFM	EM3A ^{2 3}	1LIN2.5 ⁴		
	COR30min	MWRFS	EM3A ²	3LIN2.5 ⁴		
		MWRFS	EM3D ^{2 3}	2G		
				C3		

1 For DALI LIN option wires are 2x0.5mm²

2 Operating temperature range for Luminaires with EM option, °C: ta 0... +35

3 EM3B, EM3A. EM3D options not applicable for models: G482, G483, G484

4 LIN options applicable for models longer than 800mm, for shorter models 5 pole terminal block included as standard

OP LT80

OP LT80 (2xversion)

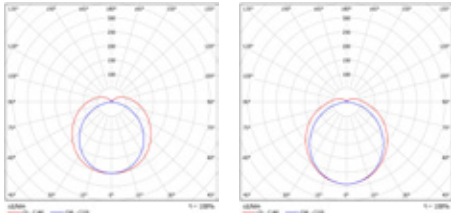

CYCLONE P LED

Waterproof and Cleanroom Luminaires



DESCRIPTION: **Surface mounted or suspended waterproof LED luminaire**
Light distribution type: direct
Optical system: opal polycarbonate diffuser, UV stable, impact resistant
Housing: polycarbonate
Colour: light grey

GENERAL DATA: **Mains voltage:** 220-240V, 0/50-60Hz
LED lifetime, h: 50000/L90B10
SDCM: 3
Protection class IEC: I
Ingress protection code: IP69
Mechanical impact resistance: IK10
Protection symbol: D
Glow wire test, °C: 850
Operating temperature range, °C: ta -25..+40/ +45/ +50

INSTALLATION: On the ceiling or wall (mounting brackets included), or suspended (hooks included), quick and tool-free mounting. 3/5 pole waterproof connector

ENVIRONMENT: Indoor/outdoor with roof

APPLICATION: Industry, food processing area, warehouse, sports, public place, parking area, transport terminal, work-s. Resists to dust, humidity and washing with hot water ($\leq 80^{\circ}\text{C}$)



PRODUCT	LENGTH, mm	WIDTH, mm	HEIGHT, mm	LUMINAIRE OUTPUT*, lm	SYSTEM POWER*, W	SYSTEM EFFICACY*, lm/W	CRI	CCT*, K	WEIGHT, kg
Cyclone P LED1x3050 G347 T840 OP 1LINS 2xC3	1175	90	99	3050	22,0	139	80+	4000	1,5
Cyclone P LED1x4200 G348 T840 OP 1LINS 2xC3	1175	90	99	4180	30,0	139	80+	4000	1,5
Cyclone P LED1x6100 G349 T840 OP 1LINS 2xC3	1175	90	99	6030	43,0	140	80+	4000	1,5
Cyclone P LED1x3800 G607 T840 OP 1LINS 2xC3	1455	90	99	3770	27,0	140	80+	4000	1,8
Cyclone P LED1x5300 G608 T840 OP 1LINS 2xC3	1455	90	99	5270	37,0	142	80+	4000	1,8
Cyclone P LED1x7600 G609 T840 OP 1LINS 2xC3	1455	90	99	7570	54,0	140	80+	4000	1,8
Cyclone P LED1x10000 G610 T840 OP 1LINS 2xC3	1455	90	99	9950	71,0	140	80+	4000	1,8

*Tolerance range for optical and electrical data: $\pm 10\%$. Values apply to an ambient temperature of 25°C . NORTHCLIFFE LIGHTING is constantly developing and improving its products. The right is reserved to change any product specifications without prior notification

AVAILABLE ACCESSORIES:



Product: Suspension MTG KIT - Barat/Proof/Nord LED 1.5m

Description: Suspension kit for Barat/Proof/Nord LED luminaires, 1.5 meter, 2pcs

Product: Suspension MTG KIT - Barat/Proof/Nord LED 3.0m

Description: Suspension kit for Barat/Proof/Nord LED luminaires, 3.0 meter, 2pcs



Product: End plug

Description: End plug for Cyclone A/P LED luminaires, 1pcs

OPTIONS AVAILABLE ON REQUEST:

LED	CONTROL GEAR	CONNECTION
T830	DALI ^{1 2}	1LINS
T840		3LINS
		1ENDS
		3ENDS
		C3
		C5

- 1 For DALI LIN option wires are 2x0.5mm²
- 2 For this model DALI option is not compatible with SWITCHDIM functionality.

OP

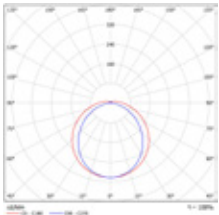

LINE CONNECTION

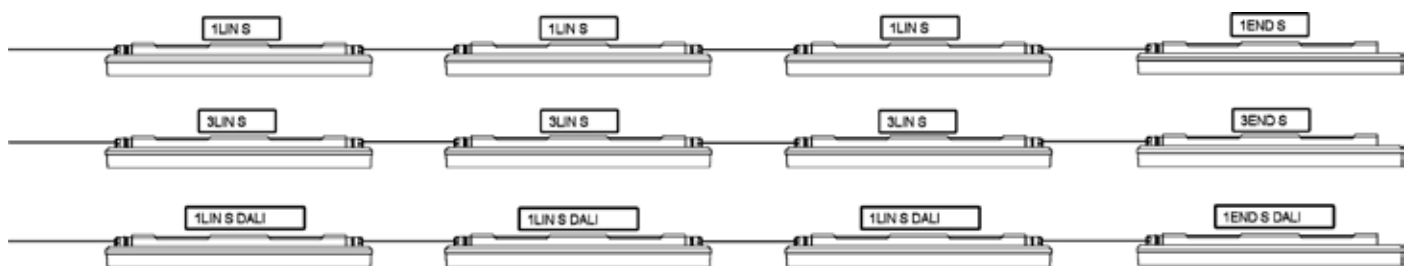

CYCLONE A LED

Waterproof and Cleanroom Luminaires



DESCRIPTION: **Surface mounted or suspended waterproof LED luminaire for use in chemically aggressive atmospheres**
Light distribution type: direct
Optical system: opal thermoplastic diffuser, good chemical resistance
Housing: thermoplastic, good chemical resistance
Colour: light grey

GENERAL DATA: **Mains voltage:** 220-240V, 0/50-60Hz
LED lifetime, h: 50000/L90B10
SDCM: 3
Protection class IEC: I
Ingress protection code: IP69
Mechanical impact resistance: IK06
Protection symbol: D
Glow wire test, °C: 850
Operating temperature range, °C: ta -25...+40/ +45/ +50

INSTALLATION: On the ceiling or wall (mounting brackets included), or suspended (hooks included), quick and tool-free mounting. 3/5 pole waterproof connector

ENVIRONMENT: Indoor/outdoor with roof

APPLICATION: Agriculture, farms, industry, warehouse, car wash units, laboratories. Suits well in aggressive environments with cleaning agents, ammonia vapours, alkaline compounds and washing with hot water ($\leq 80^{\circ}\text{C}$)



PRODUCT	LENGTH, mm	WIDTH, mm	HEIGHT, mm	LUMINAIRE OUTPUT*, lm	SYSTEM POWER*, W	SYSTEM EFFICACY*, lm/W	CRI	CCT*, K	WEIGHT, kg
Cyclone A LED1x2900 G353 T840 OP 1LINS 2xC3	1175	90	99	2890	22,0	131	80+	4000	1,5
Cyclone A LED1x4000 G354 T840 OP 1LINS 2xC3	1175	90	99	3960	30,0	132	80+	4000	1,5
Cyclone A LED1x5750 G355 T840 OP 1LINS 2xC3	1175	90	99	5710	43,0	133	80+	4000	1,5
Cyclone A LED1x3600 G356 T840 OP 1LINS 2xC3	1455	90	99	3570	27,0	132	80+	4000	1,8
Cyclone A LED1x5000 G357 T840 OP 1LINS 2xC3	1455	90	99	4990	37,0	135	80+	4000	1,8
Cyclone A LED1x7150 G358 T840 OP 1LINS 2xC3	1455	90	99	7110	54,0	132	80+	4000	1,8
Cyclone A LED1x9650 G611 T840 OP 1LINS 2xC3	1455	90	99	9620	71,0	135	80+	4000	1,8

*Tolerance range for optical and electrical data: $\pm 10\%$. Values apply to an ambient temperature of 25°C . NORTHCLIFFE LIGHTING is constantly developing and improving its products. The right is reserved to change any product specifications without prior notification

AVAILABLE ACCESSORIES:



Product: Suspension MTG KIT - Barat/Proof/Nord LED 1.5m
Description: Suspension kit for Barat/Proof/Nord LED luminaires, 1.5 meter, 2pcs

Product: Suspension MTG KIT - Barat/Proof/Nord LED 3.0m
Description: Suspension kit for Barat/Proof/Nord LED luminaires, 3.0 meter, 2pcs



Product: End plug
Description: End plug for Cyclone A/P LED luminaires, 1pcs

OPTIONS AVAILABLE ON REQUEST:

LED	CONTROL GEAR	CONNECTION
T830	DALI ^{1 2}	1LINS
T840		3LINS
		1ENDS
		3ENDS
		C3
		C5

- 1 For DALI LIN option wires are 2x0.5mm²
- 2 For this model DALI option is not compatible with SWITCHDIM functionality

OP

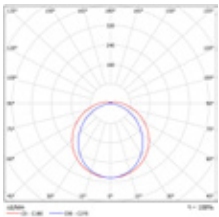

LINE CONNECTION

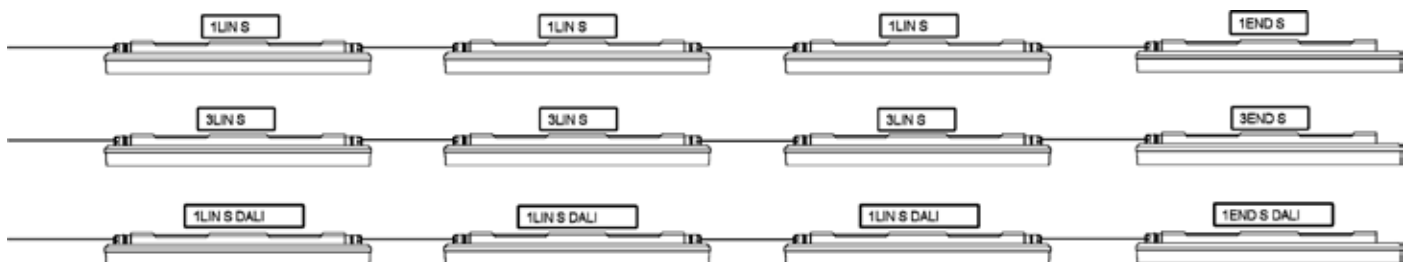

SUMATRA O LED

Waterproof and Cleanroom Luminaires



DESCRIPTION: **Surface mounted or suspended waterproof LED luminaire**
Light distribution type: direct
Optical system: polycarbonate diffuser with narrow beam (ceiling height 7,5...12m), models: J585-J588; wide beam (ceiling height 2,5...4m) models: J585-J596, UV stable, impact resistant
Housing: polycarbonate
Colour: light grey

GENERAL DATA: **Mains voltage:** 220-240V, 0/50-60Hz
LED lifetime, h: 100000/L80B50
SDCM: 3
Protection class IEC: I
Ingress protection code: IP66
Mechanical impact resistance: IK10
Operating temperature range, °C: ta -25...+45/+50

INSTALLATION: On the ceiling or wall (mounting brackets included), or suspended (hooks included). Push-in terminal, 3x2x2.5mm²

ENVIRONMENT: Indoor/outdoor with roof

APPLICATION: Industry, warehouse, hall, sports, public place, parking area, transport terminal, parking area

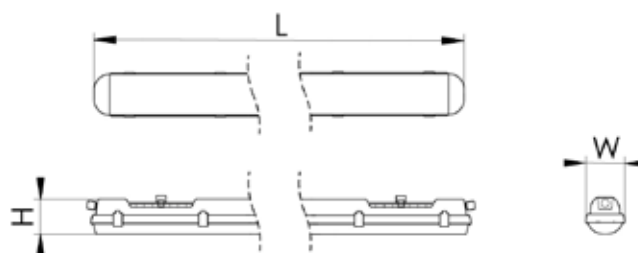

PRODUCT	LENGTH, mm	WIDTH, mm	HEIGHT, mm	LUMINAIRE OUTPUT*, lm	SYSTEM POWER*, W	SYSTEM EFFICACY*, lm/W	CRI	CCT*, K	WEIGHT, kg
Sumatra O LED1x4000 J585 PC/PC T840 L40x105	1175	98	84	3960	27,0	147	80+	4000	1,7
Sumatra O LED1x5700 J586 PC/PC T840 L40x105	1175	98	84	5700	38,0	150	80+	4000	1,7
Sumatra O LED1x4950 J587 PC/PC T840 L40x105	1455	98	84	4930	33,0	149	80+	4000	2,0
Sumatra O LED1x7050 J588 PC/PC T840 L40x105	1455	98	84	7040	45,0	156	80+	4000	2,0
Sumatra O LED1x2400 J589 PC/PC T840 L120x105	1175	98	84	2400	16,0	150	80+	4000	1,7
Sumatra O LED1x2900 J590 PC/PC T840 L120x105	1175	98	84	2890	20,0	145	80+	4000	1,7
Sumatra O LED1x4050 J591 PC/PC T840 L120x105	1175	98	84	4050	27,0	150	80+	4000	1,7
Sumatra O LED1x5850 J592 PC/PC T840 L120x105	1175	98	84	5820	38,0	153	80+	4000	1,7
Sumatra O LED1x3050 J593 PC/PC T840 L120x105	1455	98	84	3010	20,0	151	80+	4000	2,0
Sumatra O LED1x3650 J594 PC/PC T840 L120x105	1455	98	84	3610	24,0	150	80+	4000	2,0
Sumatra O LED1x5050 J595 PC/PC T840 L120x105	1455	98	84	5040	33,0	153	80+	4000	2,0
Sumatra O LED1x7200 J596 PC/PC T840 L120x105	1455	98	84	7200	45,0	160	80+	4000	2,0

*Tolerance range for optical and electrical data: ±10%. Values apply to an ambient temperature of 25°C. NORTHCLIFFE LIGHTING is constantly developing and improving its products. The right is reserved to change any product specifications without prior notification

OPTIONS AVAILABLE ON REQUEST:

LED	CONTROL GEAR	SENSORS	EMERGENCY	CONNECTION	OTHER	PROTECTION
T830	DALI ¹	HBPIR7m-M ²	EM3B ³	5TB	IC	II
T840	COR		EM3A ³	1LIN		
	COR1min		EM3Atmin-25	3LIN		
	COR30min		EM3D ³	1LIN2.5		
				3LIN2.5		
				C3		

- 1 For DALI LIN option wires are 2x0.5mm²
- 2 Luminaire with integrated HBPIR7m-M sensor protection degrees are IP65 and IK05
- 3 Operating temperature range for Luminaires with EM option, °C: ta 0... +35

L40x105

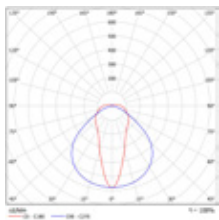

L120x105

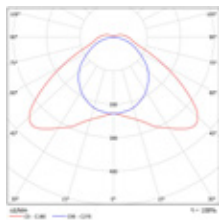



SUMATRA LED

Waterproof and Cleanroom Luminaires



DESCRIPTION: **Surface mounted or suspended waterproof LED luminaire**
Light distribution type: direct
Optical system: opal polycarbonate diffuser, UV stable, impact resistant
Housing: polycarbonate
Colour: light grey

GENERAL DATA: **Mains voltage:** 220-240V, 50-60Hz, basic version: 220-240V, 50-60Hz / 220-240V, 0/50-60Hz
LED lifetime, h: 100000/L80B10, basic version: 50000/L80B10
SDCM: 3
Protection class IEC: I
Ingress protection code: IP66
Mechanical impact resistance: IK10
Operating temperature range, °C: ta -20...+35/+40, basic version: ta -20...+35

INSTALLATION: On the ceiling or wall (mounting brackets included), or suspended (hooks included). Push-in terminal, 3x2x2.5mm²

ENVIRONMENT: Indoor/outdoor with roof

APPLICATION: Industry, warehouse, hall, sports, public place, parking area, transport terminal, parking area

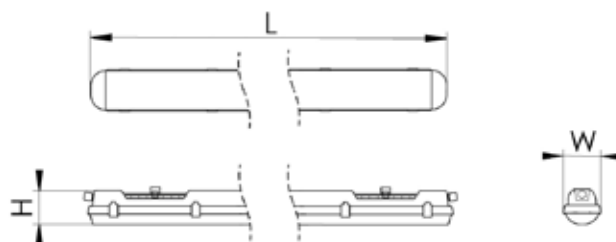

PRODUCT	LENGTH, mm	WIDTH, mm	HEIGHT, mm	LUMINAIRE OUTPUT*, lm	SYSTEM POWER*, W	SYSTEM EFFICACY*, lm/W	CRI	CCT*, K	WEIGHT, kg
Sumatra LED1x1500 J738 PC/PC T840 OP	615	98	84	1464	9,3	157	80+	4000	0,9
Sumatra LED1x1700 J739 PC/PC T840 OP	615	98	84	1654	10,8	153	80+	4000	0,9
Sumatra LED1x2200 J740 PC/PC T840 OP	615	98	84	2197	14,0	157	80+	4000	0,9
Sumatra LED1x2500 J741 PC/PC T840 OP	615	98	84	2481	15,7	158	80+	4000	0,9
Sumatra LED1x2950 J742 PC/PC T840 OP	615	98	84	2929	18,2	161	80+	4000	0,9
Sumatra LED1x3350 J743 PC/PC T840 OP	615	98	84	3307	20,7	160	80+	4000	0,9
Sumatra LED1x3700 J744 PC/PC T840 OP	615	98	84	3661	22,2	165	80+	4000	0,9
Sumatra LED1x4150 J745 PC/PC T840 OP	615	98	84	4134	25,8	160	80+	4000	0,9
Sumatra LED1x4400 J746 PC/PC T840 OP	615	98	84	4393	26,3	167	80+	4000	0,9
Sumatra LED1x5000 J747 PC/PC T840 OP	615	98	84	4961	30,3	164	80+	4000	0,9
Sumatra LED1x2950 J748 PC/PC T840 OP	1175	98	84	2929	18,0	163	80+	4000	1,7
Sumatra LED1x3350 J749 PC/PC T840 OP	1175	98	84	3307	20,9	158	80+	4000	1,7
Sumatra LED1x4400 J750 PC/PC T840 OP	1175	98	84	4393	26,3	167	80+	4000	1,7
Sumatra LED1x5000 J751 PC/PC T840 OP	1175	98	84	4961	30,3	164	80+	4000	1,7
Sumatra LED1x5900 J752 PC/PC T840 OP	1175	98	84	5858	33,6	174	80+	4000	1,7
Sumatra LED1x6650 J753 PC/PC T840 OP	1175	98	84	6615	38,6	171	80+	4000	1,7
Sumatra LED1x7350 J754 PC/PC T840 OP	1175	98	84	7322	41,5	176	80+	4000	1,7
Sumatra LED1x8300 J755 PC/PC T840 OP	1175	98	84	8269	47,2	175	80+	4000	1,7
Sumatra LED1x8800 J756 PC/PC T840 OP	1175	98	84	8787	49,3	178	80+	4000	1,7
Sumatra LED1x9950 J757 PC/PC T840 OP	1175	98	84	9922	56,7	175	80+	4000	1,7

PRODUCT	LENGTH, mm	WIDTH, mm	HEIGHT, mm	LUMINAIRE OUTPUT*, lm	SYSTEM POWER*, W	SYSTEM EFFICACY*, lm/W	CRI	CCT*, K	WEIGHT, kg
Sumatra LED1x5500 J758 PC/PC T840 OP	1455	98	84	5492	31,5	174	80+	4000	2,0
Sumatra LED1x6250 J759 PC/PC T840 OP	1455	98	84	6202	36,2	171	80+	4000	2,0
Sumatra LED1x7350 J760 PC/PC T840 OP	1455	98	84	7322	41,5	176	80+	4000	2,0
Sumatra LED1x8300 J761 PC/PC T840 OP	1455	98	84	8269	47,2	175	80+	4000	2,0
Sumatra LED1x9200 J762 PC/PC T840 OP	1455	98	84	9153	51,3	178	80+	4000	2,0
Sumatra LED1x10350 J763 PC/PC T840 OP	1455	98	84	10336	59	175	80+	4000	2,0
Sumatra LED1x11000 J764 PC/PC T840 OP	1455	98	84	10983	61,6	178	80+	4000	2,0
Sumatra LED1x12450 J765 PC/PC T840 OP	1455	98	84	12403	70,9	175	80+	4000	2,0
Sumatra LED1x1950 H227 PC/PC T840 OP	615	98	84	1916	13,9	138	80+	4000	0,9
Sumatra LED1x2600 H228 PC/PC T840 OP	615	98	84	2555	18,1	141	80+	4000	0,9
Sumatra LED1x3200 H229 PC/PC T840 OP	615	98	84	3194	20,9	153	80+	4000	0,9
Sumatra LED1x3850 H230 PC/PC T840 OP	615	98	84	3833	25,1	153	80+	4000	0,9
Sumatra LED1x2600 H231 PC/PC T840 OP	1175	98	84	2556	18,1	141	80+	4000	1,7
Sumatra LED1x3850 H232 PC/PC T840 OP	1175	98	84	3832	25,1	153	80+	4000	1,7
Sumatra LED1x5150 H233 PC/PC T840 OP	1175	98	84	5109	33,5	153	80+	4000	1,7
Sumatra LED1x6400 H234 PC/PC T840 OP	1175	98	84	6387	41,9	152	80+	4000	1,7
Sumatra LED1x7700 H235 PC/PC T840 OP	1175	98	84	7665	50,3	152	80+	4000	1,7
Sumatra LED1x3200 H236 PC/PC T840 OP	1455	98	84	3195	20,9	153	80+	4000	2,0
Sumatra LED1x4800 H237 PC/PC T840 OP	1455	98	84	4790	31,4	153	80+	4000	2,0
Sumatra LED1x6400 H238 PC/PC T840 OP	1455	98	84	6387	41,9	152	80+	4000	2,0
Sumatra LED1x8000 H239 PC/PC T840 OP	1455	98	84	7984	52,3	153	80+	4000	2,0
Sumatra LED1x9600 H240 PC/PC T840 OP	1455	98	84	9581	60,8	158	80+	4000	2,0

*Tolerance range for optical and electrical data: ±10%. Values apply to an ambient temperature of 25°C. NORTHCLIFFE LIGHTING is constantly developing and improving its products. The right is reserved to change any product specifications without prior notification

AVAILABLE ACCESSORIES:



Product: Suspension MTG KIT - Barat/Proof/Nord LED 1.5m
Description: Suspension kit for Barat/Proof/Nord LED luminaires, 1.5 meter, 2pcs

Product: Suspension MTG KIT - Barat/Proof/Nord LED 3.0m
Description: Suspension kit for Barat/Proof/Nord LED luminaires, 3.0 meter, 2pcs

OPTIONS AVAILABLE ON REQUEST:

LED	CONTROL GEAR	SENSORS	EMERGENCY	CONNECTION	OTHER	PROTECTION
T830	DALI ¹	HBPIR7m-M ²	EM3 ⁵	5TB	IC	II
T840	COR	HBPIR15m-M ^{2 3}	EMGB ⁵	1LIN ⁷		
	COR1min	DALI HBPIRD15m-M ^{2 4}	EM3B ⁵	2LIN ⁷		
	COR30min	KRBLT HBPIR15m-M ^{2 3}	EM3A ^{5 6}	3LIN ⁷		
	eCOR MW	DALI KRBLT HBPIRD15m-M ^{2 4}	EM3Atmin-25 ⁶	1LIN2.5 ⁷		
			EM3D ^{5 6}	2LIN2.5 ⁷		
				3LIN2.5 ⁷		
				C3		

1 For DALI LIN option wires are 2x0.5mm²

2 Luminaire with integrated HBPIR7m-M, HBPIR15m-M, DALI HBPIRD15m-M, KRBLT HBPIR15m-M, DALI KRBLT HBPIRD15m-M sensors protection degrees are IP65 and IK05

3 Max. switching load up to 2A

4 Max. 15 DALI slaves

5 Operating temperature range for Luminaires with EM option, °C: ta 0... +35

6 Options EM3A, EM3Atmin-25 and EM3D not applicable for models: J738, J739, J740, J741, J742, J743, J744, J745, J746, J747, H227, H228, H229, H230

7 LIN options applicable for models longer than 800mm, for shorter models 5TB option

STANDARD

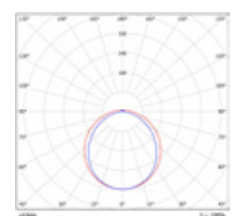

SUMATRA C LED

Waterproof and Cleanroom Luminaires

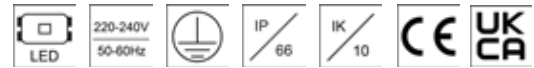

DESCRIPTION: **Surface mounted or suspended waterproof LED luminaire**
Light distribution type: direct/indirect
Optical system: opal polycarbonate diffuser, UV stable, impact resistant
Housing: polycarbonate
Colour: transparent

GENERAL DATA: **Mains voltage:** 220-240V, 50-60Hz / 220-240V, 0/50-60Hz
LED lifetime, h: 100000/L80B10
SDCM: 3
Protection class IEC: I
Ingress protection IEC code: IP66
Mechanical impact resistance: IK10
Operating temperature range, °C: ta -20...+35/+40

INSTALLATION: On the ceiling or wall (mounting brackets included), or suspended (hooks included). Push-in terminal, 3x2x2.5mm²

ENVIRONMENT: Indoor/outdoor with roof

APPLICATION: Industry, warehouse, hall, sports, public place, parking area, transport terminal, parking area

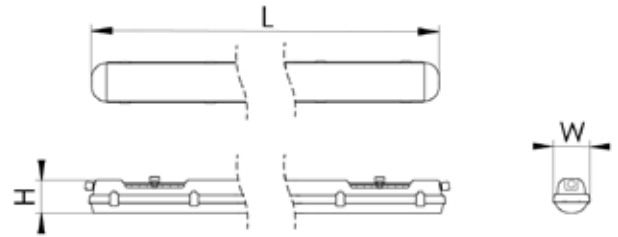

PRODUCT	LENGTH, mm	WIDTH, mm	HEIGHT, mm	LUMINAIRE OUTPUT*, lm	SYSTEM POWER*, W	SYSTEM EFFICACY*, lm/W	CRI	CCT*, K	WEIGHT, kg
Sumatra C LED1x3000 J597 PC/PC T840 OP	1175	98	84	2992	18,0	166	80+	4000	1,7
Sumatra C LED1x4500 J598 PC/PC T840 OP	1175	98	84	4488	26,3	171	80+	4000	1,7
Sumatra C LED1x6000 J599 PC/PC T840 OP	1175	98	84	5984	33,6	178	80+	4000	1,7
Sumatra C LED1x6800 J600 PC/PC T840 OP	1175	98	84	6757	38,6	175	80+	4000	1,7
Sumatra C LED1x7500 J601 PC/PC T840 OP	1175	98	84	7480	41,5	180	80+	4000	1,7
Sumatra C LED1x6350 J602 PC/PC T840 OP	1455	98	84	6335	36,2	175	80+	4000	2,0
Sumatra C LED1x7500 J603 PC/PC T840 OP	1455	98	84	7480	41,5	180	80+	4000	2,0
Sumatra C LED1x8450 J604 PC/PC T840 OP	1455	98	84	8447	47,2	179	80+	4000	2,0
Sumatra C LED1x9350 J605 PC/PC T840 OP	1455	98	84	9350	51,3	182	80+	4000	2,0

*Tolerance range for optical and electrical data: ±10%. Values apply to an ambient temperature of 25°C. NORTHCLIFFE LIGHTING is constantly developing and improving its products. The right is reserved to change any product specifications without prior notification

AVAILABLE ACCESSORIES:



Product: Suspension MTG KIT - Barat/Proof/Nord LED 1.5m
Description: Suspension kit for Barat/Proof/Nord LED luminaires, 1,5 meter, 2pcs

Product: Suspension MTG KIT - Barat/Proof/Nord LED 3.0m
Description: Suspension kit for Barat/Proof/Nord LED luminaires, 3,0 meter, 2pcs

OPTIONS AVAILABLE ON REQUEST:

LED	CONTROL GEAR	SENSORS	EMERGENCY	CONNECTION	OTHER	PROTECTION
T830	DALI ¹	HBPIR7m-M ²	EM3 ⁴	5TB	IC	II
T840	COR	HBPIR15m-M ^{2 3}	EMGB ⁴	1LIN		
	COR1min	DALI HBPIRD15m-M ^{2 4}	EM3B ⁴	2LIN		
	COR30min	KRBLT HBPIR15m-M ^{2 3}	EM3A ⁴	3LIN		
	eCOR MW	DALI KRBLT HBPIRD15m-M ^{2 4}	EM3Atmin-25	1LIN2.5		
			EM3D ⁴	2LIN2.5		
				3LIN2.5		
				C3		

1 For DALI LIN option wires are 2x0.5mm²

2 Luminaire with integrated HBPIR7m-M, HBPIR15m-M, DALI HBPIRD15m-M, KRBLT HBPIR15m-M, DALI KRBLT HBPIRD15m-M sensors protection degrees are IP65 and IK05

3 Max. switching load up to 2A

4 Max. 15 DALI slaves

5 Operating temperature range for Luminaires with EM option, °C: ta 0... +35

STANDARD

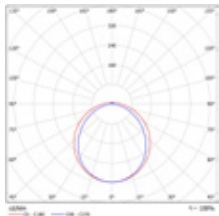

CUJAM LED

Waterproof and Cleanroom Luminaires



DESCRIPTION: **Surface mounted waterproof basic LED luminaire**
Light distribution type: direct
Optical system: opal polycarbonate diffuser
Housing: polycarbonate
Colour: white

GENERAL DATA: **Mains voltage:** 220-240V, 50-60Hz
LED lifetime, h: 25000/L70B50
SDCM: 5
Protection class IEC: II
Ingress protection code: IP65
Mechanical impact resistance: IK07
Operating temperature range, °C: ta -20...+40

INSTALLATION: On the ceiling or wall (mounting brackets included), or suspended. Cable, 0.25m, 2x0.75mm²

ENVIRONMENT: Indoor

APPLICATION: Industry, warehouse, public place, parking area



PRODUCT	LENGTH, mm	WIDTH, mm	HEIGHT, mm	LUMINAIRE OUTPUT*, lm	SYSTEM POWER*, W	SYSTEM EFFICACY*, lm/W	CRI	CCT*, K	WEIGHT, kg
Cujam LED1x3600 D595 T740 OP	1200	60	35	3600	36,0	100	70+	4000	0,4
Cujam LED1x4800 D596 T740 OP	1500	60	35	4800	46,0	104	70+	4000	0,5

*Tolerance range for optical and electrical data: ±10%. Values apply to an ambient temperature of 25°C. NORTHCLIFFE LIGHTING is constantly developing and improving its products. The right is reserved to change any product specifications without prior notification

Note - luminaire is not suitable for frequent switching

OP

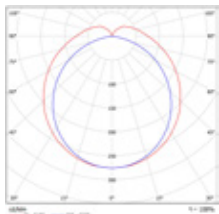

BARAT

Waterproof and Cleanroom Luminaires



DESCRIPTION: **Surface mounted waterproof luminaire for LED tubes**
Light distribution type: direct
Optical system: opal polycarbonate diffuser, UV stable
Housing: polycarbonate
Colour: light grey

GENERAL DATA: **Light source:** LED / LEDS / LEDD
Mains voltage: 220-240V, 50-60Hz
Protection class IEC: I
Ingress protection code: IP66
Mechanical impact resistance: IK06
Protection symbol: D
Operating temperature range, °C: ta -20...+40

INSTALLATION: On the ceiling or wall (mounting brackets included), or suspended (hooks included). Push-in terminal, 3x2x2.5mm²

ENVIRONMENT: Indoor

APPLICATION: Industry, warehouse, hall, sports, public place, parking area, transport terminal, parking area

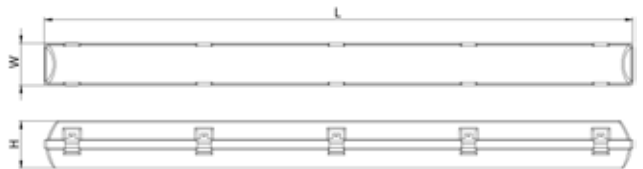

PRODUCT	LENGTH, mm	WIDTH, mm	HEIGHT, mm	LUMINAIRE OUTPUT*, lm	WEIGHT, kg
Barat 118 I14 LED ABS/PMMA	662	96	111	1xT8 LED (G13)	0,8
Barat 218 I15 LED ABS/PMMA	662	146	111	2xT8 LED (G13)	1,1
Barat 136 I16 LED ABS/PMMA	1272	96	111	1xT8 LED (G13)	1,6
Barat 236 I17 LED ABS/PMMA	1272	146	111	2xT8 LED (G13)	2,1
Barat 158 I18 LED ABS/PMMA	1572	96	111	1xT8 LED (G13)	1,9
Barat 258 I19 LED ABS/PMMA	1572	146	111	2xT8 LED (G13)	2,5
Barat 118 I14 LED ABS/PMMA IC	662	96	111	1xT8 LED (G13)	0,8
Barat 218 I15 LED ABS/PMMA IC	662	146	111	2xT8 LED (G13)	1,1
Barat 136 I16 LED ABS/PMMA IC	1272	96	111	1xT8 LED (G13)	1,6
Barat 236 I17 LED ABS/PMMA IC	1272	146	111	2xT8 LED (G13)	2,1
Barat 158 I18 LED ABS/PMMA IC	1572	96	111	1xT8 LED (G13)	1,9
Barat 258 I19 LED ABS/PMMA IC	1572	146	111	2xT8 LED (G13)	2,5
Barat 118 I14 LED ABS/PC	662	96	111	1xT8 LED (G13)	0,8
Barat 218 I15 LED ABS/PC	662	146	111	2xT8 LED (G13)	1,1
Barat 136 I16 LED ABS/PC	1272	96	111	1xT8 LED (G13)	1,6
Barat 236 I17 LED ABS/PC	1272	146	111	2xT8 LED (G13)	2,1
Barat 158 I18 LED ABS/PC	1572	96	111	1xT8 LED (G13)	1,9
Barat 258 I19 LED ABS/PC	1572	146	111	2xT8 LED (G13)	2,5
Barat 118 I14 LED ABS/PC IC	662	96	111	1xT8 LED (G13)	0,8
Barat 218 I15 LED ABS/PC IC	662	146	111	2xT8 LED (G13)	1,1
Barat 136 I16 LED ABS/PC IC	1272	96	111	1xT8 LED (G13)	1,6
Barat 236 I17 LED ABS/PC IC	1272	146	111	2xT8 LED (G13)	2,1
Barat 158 I18 LED ABS/PC IC	1572	96	111	1xT8 LED (G13)	1,9
Barat 258 I19 LED ABS/PC IC	1572	146	111	2xT8 LED (G13)	2,5

*Tolerance range for optical and electrical data: ±10%. Values apply to an ambient temperature of 25°C. NORTHCLIFFE LIGHTING is constantly developing and improving its products. The right is reserved to change any product specifications without prior notification

Note - check wiring diagram before placing order: LED, LEDS, LEDD

HERCULES LED

Waterproof and Cleanroom Luminaires



DESCRIPTION: **Waterproof IP66 LED luminaire with aluminium body and tempered glass diffuser. Suits well in aggressive atmospheres with cleaning agents, salts, acids and mineral oils**

Diffuser: tempered safety glass, impact resistant, with stainless steel clips and safety clips

Optical system: lenses

Body: extruded aluminium, light grey finish, RAL9006

Brass cable gland and polyurethane sealing to provide reliable IP protection

GENERAL DATA: **Mains voltage:** 220-240V, 0/50-60Hz

LED lifetime, h: 100000/L80B10

SDCM: 3

Protection class IEC: I

Ingress protection code: IP66

Mechanical impact resistance: IK10

Protection symbol: D

Glow wire test, °C: 850

Operating temperature range, °C: ta -25...+40

INSTALLATION: Surface luminaire designed to be fixed to ceiling of any type or suspended. Push-in terminal, 3x2x2.5mm²

ENVIRONMENT: Indoor

APPLICATION: Industry, food processing area, warehouse, hall, agriculture

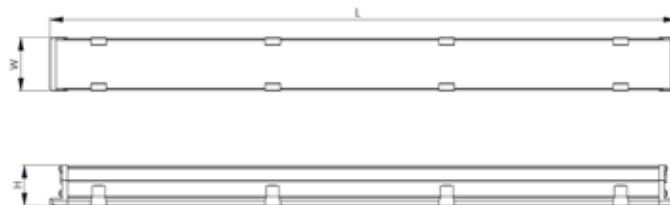

PRODUCT	LENGTH, mm	WIDTH, mm	HEIGHT, mm	LUMINAIRE OUTPUT*, lm	SYSTEM POWER*, W	SYSTEM EFFICACY*, lm/W	CRI	CCT*, K	WEIGHT, kg
Hercules LED1x3800 G990 T840 L75	1224	105	75	3797	21,8	174	80+	4000	4,8
Hercules LED1x5300 G991 T840 L75	1224	105	75	5260	31,7	166	80+	4000	4,8
Hercules LED1x7600 G992 T840 L75	1224	105	75	7554	41,6	182	80+	4000	4,8
Hercules LED1x4750 G993 T840 L75	1524	105	75	4745	26,7	178	80+	4000	5,5
Hercules LED1x6600 G994 T840 L75	1524	105	75	6575	39,1	168	80+	4000	5,5
Hercules LED1x9450 G995 T840 L75	1524	105	75	9443	52,0	182	80+	4000	5,5

*Tolerance range for optical and electrical data: ±10%. Values apply to an ambient temperature of 25°C. NORTHCLIFFE LIGHTING is constantly developing and improving its products. The right is reserved to change any product specifications without prior notification

OPTIONS AVAILABLE ON REQUEST:

LED	REFLECTOR AND OPTICS	CONTROL GEAR	EMERGENCY	CONNECTION
T830	L30	DALI ¹	EM3 ²	5TB
T840	L40x75	COR	EM3B ²	1LIN
	L75	COR1min	EM3A ²	3LIN
	L75W	COR30min	EM3D ²	1LIN2.5
	L90W		EM3Atmin-25	3LIN2.5
	L1A18			
	L2A25			

1 For DALI LIN option wires are 2x0.5mm²

2 Operating temperature range for Luminaires with EM option, C: ta 0... +35



INOX LED

Waterproof and Cleanroom Luminaires



DESCRIPTION: **Surface mounted waterproof IP65 LED luminaire for chemically aggressive atmospheres with cleaning agents, salts, acids and mineral oils**
Light distribution type: direct
Optical system: frosted tempered glass diffuser, impact resistant
Housing: SS304 stainless steel, impact and chemically resistant
 Brass cable gland and silicone sealing gasket to provide reliable IP protection
Colour: stainless steel

GENERAL DATA: **Mains voltage:** 220-240V, 0/50-60Hz
LED lifetime, h: 100000/L80B10
SDCM: 3
Protection class IEC: I
Ingress protection code: IP65
Mechanical impact resistance: IK10
Protection symbol: D
Glow wire test, °C: 960
Operating temperature range, °C: ta -20...+35/+40

INSTALLATION: Surface luminaire designed to be fixed to ceiling of any type or suspended. Kit includes fasteners for surface, suspension and horizontal line installation. Push-in terminal, 3x2x2.5mm²

ENVIRONMENT: Indoor/Outdoor with roof

APPLICATION: Industry, food processing area, warehouse, garages, agriculture

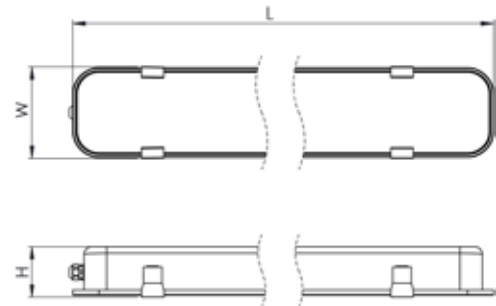

PRODUCT	LENGTH, mm	WIDTH, mm	HEIGHT, mm	LUMINAIRE OUTPUT*, lm	SYSTEM POWER*, W	SYSTEM EFFICACY*, lm/W	CRI	CCT*, K	WEIGHT, kg
Inox LED1x3450 J508 T840	1290	120	67	3424	21,9	156	80+	4000	4,3
Inox LED1x4250 J509 T840	1290	120	67	4202	27,5	153	80+	4000	4,3
Inox LED1x5000 J510 T840	1290	120	67	4978	33,0	151	80+	4000	4,3
Inox LED1x6600 J736 T840	1290	120	67	6568	43,3	152	80+	4000	4,3
Inox LED1x5300 J511 T840	1600	120	67	5252	34,0	154	80+	4000	5,3
Inox LED1x6250 J512 T840	1600	120	67	6222	40,8	153	80+	4000	5,3
Inox LED1x8250 J513 T840	1600	120	67	8211	54,1	152	80+	4000	5,3
Inox LED1x11100 J828 T840	1600	120	67	11099	71,1	156	80+	4000	5,3

*Tolerance range for optical and electrical data: ±10%. Values apply to an ambient temperature of 25°C. NORTHCLIFFE LIGHTING is constantly developing and improving its products. The right is reserved to change any product specifications without prior notification

OPTIONS AVAILABLE ON REQUEST:

LED	CONTROL GEAR	EMERGENCY	CONNECTION
T830	DALI ¹	EM3 ²	5TB
T840	COR	EM3B ²	1LIN
	COR1min	EM3A ²	3LIN
	COR30min	EM3D ²	1LIN2.5
		EM3Atmin-25	3LIN2.5

1 For DALI LIN option wires are 2x0.5mm²

2 Operating temperature range for Luminaires with EM option, °C: ta 0... +35

STANDARD

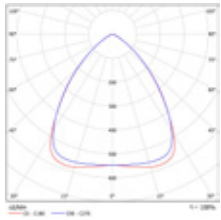

HERMETIC R LED

Waterproof and Cleanroom Luminaires



- DESCRIPTION:** **Recessed mounted cleanroom LED luminaire**
Light distribution type: direct
Optical system: opal acrylic diffuser, high chemical resistance
Housing: steel
Colour: white, RAL9003
-
- GENERAL DATA:** **Mains voltage:** 220-240V, 0/50-60Hz
LED lifetime, h: 100000/L80B10
SDCM: 3
Protection class IEC: I
Ingress protection code: IP65
Mechanical impact resistance: IK05
Operating temperature range, °C: -10...+35
-
- INSTALLATION:** In modular suspended ceilings, in ceilings with cut-out openings (mounting brackets to be ordered separately). Push-in terminal, 3x2x2,5mm²
-
- ENVIRONMENT:** Indoor
-
- APPLICATION:** Healthcare, laboratory, industry

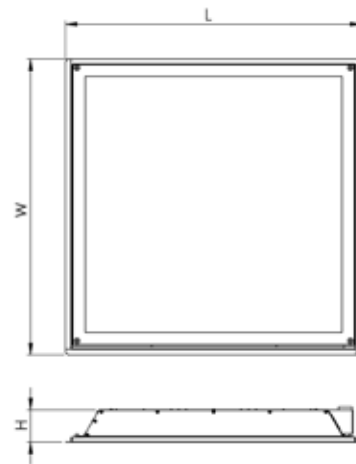

PRODUCT	LENGTH, mm	WIDTH, mm	HEIGHT, mm	LUMINAIRE OUTPUT*, lm	SYSTEM POWER*, W	SYSTEM EFFICACY*, lm/W	CRI	CCT*, K	WEIGHT, kg
Hermetic R LED2x950 J514 T840 OP LT80	595	295	66	1809	14,0	129	80+	4000	2,6
Hermetic R LED2x1150 J515 T840 OP LT80	595	295	66	2260	17,9	126	80+	4000	2,6
Hermetic R LED2x1350 J516 T840 OP LT80	595	295	66	2689	19,9	135	80+	4000	2,6
Hermetic R LED3x950 J517 T840 OP LT80	595	595	66	2713	19,8	137	80+	4000	4,2
Hermetic R LED3x1150 J518 T840 OP LT80	595	595	66	3390	25,8	131	80+	4000	4,2
Hermetic R LED3x1350 J519 T840 OP LT80	595	595	66	4033	28,9	140	80+	4000	4,2
Hermetic R LED4x950 J520 T840 OP LT80	595	595	66	3617	26,1	139	80+	4000	4,2
Hermetic R LED4x1150 J521 T840 OP LT80	595	595	66	4521	33,7	134	80+	4000	4,2
Hermetic R LED4x1350 J522 T840 OP LT80	595	595	66	5377	38,1	141	80+	4000	4,2
Hermetic R LED2x2150 J523 T840 OP LT80	1195	295	66	4220	30,0	141	80+	4000	4,3
Hermetic R LED2x2650 J524 T840 OP LT80	1195	295	66	5274	39,8	133	80+	4000	4,3
Hermetic R LED2x3150 J525 T840 OP LT80	1195	295	66	6274	43,5	144	80+	4000	4,3
Premium models with fully diffused light source									
Hermetic R LED1x4900 J526 T840 OP LT80	595	595	66	4867	32,3	151	80+	4000	4,2
Hermetic R LED1x5750 J527 T840 OP LT80	595	595	66	5738	39,1	147	80+	4000	4,2
Hermetic R LED1x6650 J528 T840 OP LT80	595	595	66	6632	45,6	145	80+	4000	4,2
Hermetic R LED1x5000 J529 T840 OP LT80	1195	295	66	4977	33,0	151	80+	4000	4,3
Hermetic R LED1x5900 J530 T840 OP LT80	1195	295	66	5868	40,0	147	80+	4000	4,3
Hermetic R LED1x6800 J531 T840 OP LT80	1195	295	66	6783	46,7	145	80+	4000	4,3

*Tolerance range for optical and electrical data: ±10%. Values apply to an ambient temperature of 25°C. NORTHCLIFFE LIGHTING is constantly developing and improving its products. The right is reserved to change any product specifications without prior notification

AVAILABLE ACCESSORIES:



Product: Recessed MTG FRAME
S626x626 RAL9003S
Description: Frame for LED luminaire
595x595mm installation into plasterboard
ceiling (1pcs), white steel



Product: Recessed MTG FRAME
S326x1226 RAL9003S
Description: Frame for LED luminaire
1195x295mm installation into plasterboard
ceiling (1pcs), white steel

OPTIONS AVAILABLE ON REQUEST:

LED	REFLECTOR AND OPTICS	CONTROL GEAR	EMERGENCY	CONNECTION	OTHER
T830	OP TP(a) ¹	DALI	EM3	CBF3-2.0m clear	SB
T840		EAIRB-S ^{2 3}	EM3B	CBF3-3.0m clear	
T930		BLT	EM3A		
T940			EM3D		

1 Polycarbonate diffuser is used with option TP(a). Check chemical compatibility

2 Max system size 1x EAIRB-M + 3x EAIRB-S

3 Max wire length from EAIRB-M to last EAIRB-S - 11 m

OP LT80

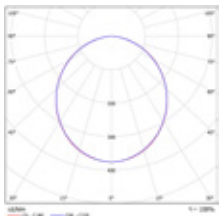

HERMETIC C LED

Waterproof and Cleanroom Luminaires



- DESCRIPTION:** Recessed mounted cleanroom LED luminaire, maintained from above the ceiling
Light distribution type: direct
Optical system: opal acrylic diffuser, high chemical resistance
Housing: steel
Colour: white, RAL9003
-
- GENERAL DATA:** **Mains voltage:** 220-240V, 0/50-60Hz
LED lifetime, h: 100000/L80B10
SDCM: 3
Protection class IEC: I
Ingress protection code: IP65
Mechanical impact resistance: IK05
Operating temperature range, °C: -10...+35
-
- INSTALLATION:** In ceilings with cut-out openings up to 60mm thick, with top mounting (mounting brackets included). Push-in terminal, 3x2x2.5mm²
-
- ENVIRONMENT:** Indoor
-
- APPLICATION:** Clean-room, healthcare, laboratory, industry

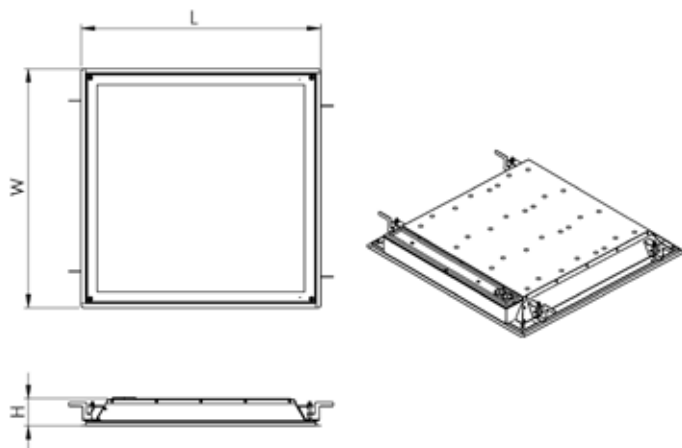

PRODUCT	LENGTH, mm	WIDTH, mm	HEIGHT, mm	LUMINAIRE OUTPUT*, lm	SYSTEM POWER*, W	SYSTEM EFFICACY*, lm/W	CRI	CCT*, K	WEIGHT, kg
Hermetic C LED3x950 J532 T840 OP LT80	595	595	100	2713	19,8	137	80+	4000	4,4
Hermetic C LED3x1150 J533 T840 OP LT80	595	595	100	3390	25,8	131	80+	4000	4,4
Hermetic C LED3x1350 J534 T840 OP LT80	595	595	100	4033	28,9	140	80+	4000	4,4
Hermetic C LED4x950 J535 T840 OP LT80	595	595	100	3617	26,1	139	80+	4000	4,4
Hermetic C LED4x1150 J536 T840 OP LT80	595	595	100	4521	33,7	134	80+	4000	4,4
Hermetic C LED4x1350 J537 T840 OP LT80	595	595	100	5377	38,1	141	80+	4000	4,4
Hermetic C LED2x2150 J538 T840 OP LT80	1195	295	100	4220	30,0	141	80+	4000	4,5
Hermetic C LED2x2650 J539 T840 OP LT80	1195	295	100	5274	39,8	133	80+	4000	4,5
Hermetic C LED2x3150 J540 T840 OP LT80	1195	295	100	6274	43,5	144	80+	4000	4,5
Premium models with fully diffused light source									
Hermetic C LED1x4900 J541 T840 OP LT80	595	595	100	4867	32,3	151	80+	4000	4,4
Hermetic C LED1x5750 J542 T840 OP LT80	595	595	100	5738	39,1	147	80+	4000	4,4
Hermetic C LED1x6650 J543 T840 OP LT80	595	595	100	6632	45,6	145	80+	4000	4,4
Hermetic C LED1x5000 J544 T840 OP LT80	1195	295	100	4977	33,0	151	80+	4000	4,5
Hermetic C LED1x5900 J545 T840 OP LT80	1195	295	100	5868	40,0	147	80+	4000	4,5
Hermetic C LED1x6800 J546 T840 OP LT80	1195	295	100	6783	46,7	145	80+	4000	4,5

*Tolerance range for optical and electrical data: ±10%. Values apply to an ambient temperature of 25°C. NORTHCLIFFE LIGHTING is constantly developing and improving its products. The right is reserved to change any product specifications without prior notification

OPTIONS AVAILABLE ON REQUEST:

LED	REFLECTOR AND OPTICS	CONTROL GEAR	EMERGENCY	CONNECTION
T830	OP TP(a) ¹	DALI	EM3	CBF3-2.0m clear
T840		EAIRB-S ^{2 3}	EM3B	CBF3-3.0m clear
T930		BLT	EM3A	
T940			EM3D	

- 1 Polycarbonate diffuser is used with option TP(a). Check chemical compatibility
- 2 Max system size 1x EAIRB-M + 3x EAIRB-S
- 3 Max wire length from EAIRB-M to last EAIRB-S - 11 m

OP LT80

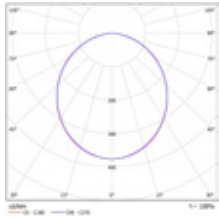



HERMETIC S LED

Waterproof and Cleanroom Luminaires



DESCRIPTION: **Surface mounted cleanroom LED luminaire**
Light distribution type: direct
Optical system: opal acrylic diffuser, high chemical resistance
Housing: steel
Colour: white, RAL9003

GENERAL DATA: **Mains voltage:** 220-240V, 0/50-60Hz
LED lifetime, h: 100000/L80B10
SDCM: 3
Protection class IEC: I
Ingress protection code: IP65
Mechanical impact resistance: IK05
Operating temperature range, °C: -10...+35

INSTALLATION: On the ceiling. Push-in terminal, 3x2x2.5mm²

ENVIRONMENT: Indoor

APPLICATION: Healthcare, laboratory, industry

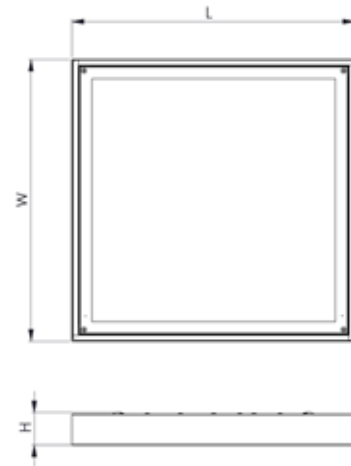

PRODUCT	LENGTH, mm	WIDTH, mm	HEIGHT, mm	LUMINAIRE OUTPUT*, lm	SYSTEM POWER*, W	SYSTEM EFFICACY*, lm/W	CRI	CCT*, K	WEIGHT, kg
Hermetic S LED3x950 J547 T840 OP LT80	595	595	69	2713	19,8	137	80+	4000	4,4
Hermetic S LED3x1150 J548 T840 OP LT80	595	595	69	3390	25,8	131	80+	4000	4,4
Hermetic S LED3x1350 J549 T840 OP LT80	595	595	69	4033	28,9	140	80+	4000	4,4
Hermetic S LED4x950 J550 T840 OP LT80	595	595	69	3617	26,1	139	80+	4000	4,4
Hermetic S LED4x1150 J551 T840 OP LT80	595	595	69	4521	33,7	134	80+	4000	4,4
Hermetic S LED4x1350 J552 T840 OP LT80	595	595	69	5377	38,1	141	80+	4000	4,4
Hermetic S LED2x2150 J553 T840 OP LT80	1195	295	69	4220	30,0	141	80+	4000	4,5
Hermetic S LED2x2650 J554 T840 OP LT80	1195	295	69	5274	39,8	133	80+	4000	4,5
Hermetic S LED2x3150 J555 T840 OP LT80	1195	295	69	6274	43,5	144	80+	4000	4,5
Premium models with fully diffused light source									
Hermetic S LED1x4900 J556 T840 OP LT80	595	595	69	4867	32,3	151	80+	4000	4,4
Hermetic S LED1x5750 J557 T840 OP LT80	595	595	69	5738	39,1	147	80+	4000	4,4
Hermetic S LED1x6650 J558 T840 OP LT80	595	595	69	6632	45,6	145	80+	4000	4,4
Hermetic S LED1x5000 J559 T840 OP LT80	1195	295	69	4977	33,0	151	80+	4000	4,5
Hermetic S LED1x5900 J560 T840 OP LT80	1195	295	69	5868	40,0	147	80+	4000	4,5
Hermetic S LED1x6800 J561 T840 OP LT80	1195	295	69	6783	46,7	145	80+	4000	4,5

*Tolerance range for optical and electrical data: ±10%. Values apply to an ambient temperature of 25°C. NORTHCLIFFE LIGHTING is constantly developing and improving its products. The right is reserved to change any product specifications without prior notification

OPTIONS AVAILABLE ON REQUEST:

LED	CONTROL GEAR	EMERGENCY
T830	DALI	EM3
T840	EAIRB-S ^{1 2}	EM3B
T930	BLT	EM3A
T940		EM3D

1 Max system size 1x EAIRB-M + 3x EAIRB-S

2 Max wire length from EAIRB-M to last EAIRB-S - 11 m

OP LT80

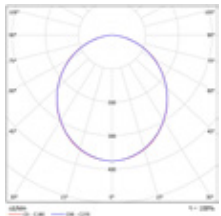

NAVI P LED

Waterproof and Cleanroom Luminaires



DESCRIPTION: Recessed mounted LED panel
Light distribution type: direct
Optical system: opal diffuser
Housing: aluminum
Colour: white, RAL9016

GENERAL DATA: Mains voltage: 220-240V, 50-60Hz
LED lifetime, h: 50000/L70B50
SDCM: 5
Protection class IEC: II
Ingress protection code: IP54
Mechanical impact resistance: IK02
Operating temperature range, °C: ta 0...+35

INSTALLATION: In modular suspended ceilings (600), in ceilings with cut-out openings (accessories to be ordered separately). Push-in terminal, 2x2x2.5mm²

ENVIRONMENT: Indoor

APPLICATION: Healthcare, laboratory, industry

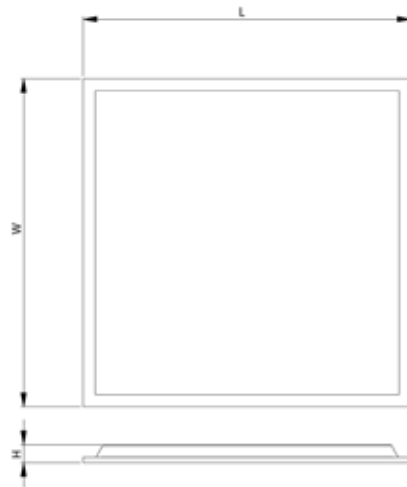

PRODUCT	LENGTH, mm	WIDTH, mm	HEIGHT, mm	LUMINAIRE OUTPUT*, lm	SYSTEM POWER*, W	SYSTEM EFFICACY*, lm/W	CRI	CCT*, K	WEIGHT, kg
Navi P LED1x3650 G616 T840 OP	595	595	33	3650	36,0	101	80+	4000	2,5
Navi P LED1x3650 G617 T840 OP	1195	295	33	3650	36,0	101	80+	4000	2,5

*Tolerance range for optical and electrical data: ±10%. Values apply to an ambient temperature of 25°C. NORTHCLIFFE LIGHTING is constantly developing and improving its products. The right is reserved to change any product specifications without prior notification

AVAILABLE ACCESSORIES:



Product: Recessed MTG FRAME S626x626 RAL9003S
Description: Frame for LED luminaire 595x595mm installation into plasterboard ceiling (1pcs), white steel



Product: Recessed MTG FRAME S326x1226 RAL9003S
Description: Frame for LED luminaire 1195x295mm installation into plasterboard ceiling (1pcs), white steel

OPTIONS AVAILABLE ON REQUEST:

LED	CONTROL GEAR	EMERGENCY
T830	DALI	EM3
T840		EM3B
		EM3A
		EM3D

OP

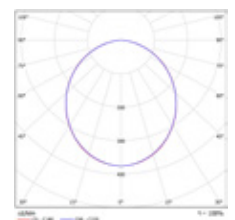

ENVIRONMENT	MAX. CONCENTRATION	SUMATRA LED, BARAT LED, CYCLONE P LED: DIFFUSER AND BODY RESISTANCE			PROOF LED, CYCLONE A LED: DIFFUSER RESISTANCE			PROOF LED, CYCLONE A LED: BODY RESISTANCE		
		yes	partially	no	yes	partially	no	yes	partially	no
Aceton (ketones)				■			■			■
Aniline			■				■			■
Ammonia	5%			■	■			■		
Benzaldehyde							■			■
Benzene				■			■			■
Diethylether (ethers)				■		■				■
Potassium nitrate	40%	■			■			■		
Ethanol (alcohols)	50%	■				■			■	
Ethylacetate (esters)				■			■			■
Ethyl alcohol		■				■		■		
Phenol				■			■			■
Glycerine			■		■					
Heptane						■				■
Ammonium hydroxide	25%				■				■	
Sodium hydroxide-base	60%			■	■			■		
Sodium chloride-salt solution	15%	■			■			■		
Sulphur chloride and Calcium chloride		■			■			■		
Carbon tetrachloride and Chloric ether				■			■			■
Iron dichloride		■			■			■		
Arsenic acid and Oleic acid		■			■			■		
Citric acid	20%	■			■			■		
Nitric acid	20%		■			■			■	
Nitric acid	50%			■			■			■
Phosphoric acid	30%		■		■			■		
Hydrochloride acid	5%	■			■			■		
Hydrochloride acid	35%			■			■			■
Chromic acid	40%		■			■			■	
Formic acid	30%			■		■			■	
Acetic acid	10%	■			■			■		
Sulphuric acid	30%	■			■			■		
Methanol				■			■			■
Fuel oil			■			■		■		
Mineral oil			■		■			■		
Vegetable oil			■		■			■		
Rape oil			■		■				■	
Lamp oil			■			■			■	
Hydrogen peroxide	30%	■			■			■		
Ammonium sulphate	15%	■			■			■		
Toluene				■			■			■
Turpentine oil										■
Trichlorethylene				■			■			■
Sodium carbonate	20%	■			■			■		
Aliphatic hydrocarbons		■			■				■	
Aromatic hydrocarbons				■			■			■
Alkali				■	■			■		

EXPLOSION-PROOF LUMINAIRES



BARAT LED Ex

Explosion-Proof Luminaires



DESCRIPTION: **Surface mounted explosion-proof LED luminaire**

Light distribution type: direct

Optical system: opal polycarbonate diffuser, impact resistant

Housing: polycarbonate, stainless steel clips

Colour: light grey



Marking of explosion-protection: II 3G Ex nA IIC T6 Gc; II 3D Ex tD IIIC T85 C IP66 Dc

Explosion group: Gas: IIC, IIB, IIA Dust: IIIC, IIIB, IIIA

Hazardous zones: 2, 22

GENERAL DATA: **Mains voltage:** 220-240V, 0/50-60Hz

LED lifetime, h: 75000/L80B50

SDCM: 3

Protection class IEC: I

Ingress protection code: IP66

Mechanical impact resistance: IK08

Operating temperature range, °C: ta -25...+40

INSTALLATION: On the ceiling or wall (mounting brackets included), or suspended (hooks included). Push-in terminal, 3x2x2.5mm². Cable diameter: Ø7-13mm

ENVIRONMENT: Indoor

APPLICATION: Industry. Designed for illumination of hazardous areas where an explosive atmosphere persists for a short period



PRODUCT	LENGTH, mm	WIDTH, mm	HEIGHT, mm	LUMINAIRE OUTPUT*, lm	SYSTEM POWER*, W	SYSTEM EFFICACY*, lm/W	CRI	CCT*, K	WEIGHT, kg
Barat LED1x1300 C101 T840 PC/PC OP IC Ex	662	96	111	1389	11,6	120	80+	4000	1,3
Barat LED1x1900 C102 T840 PC/PC OP IC Ex	662	96	111	1884	17,2	110	80+	4000	1,3
Barat LED2x1300 C104 T840 PC/PC OP IC Ex	662	146	111	2779	23,2	120	80+	4000	1,8
Barat LED2x1900 C105 T840 PC/PC OP IC Ex	662	146	111	3768	32,4	116	80+	4000	1,8
Barat LED1x2600 C107 T840 PC/PC OP IC Ex	1272	96	111	2779	23,2	120	80+	4000	2,1
Barat LED1x3800 C108 T840 PC/PC OP IC Ex	1272	96	111	3768	32,4	116	80+	4000	2,1
Barat LED2x2600 C110 T840 PC/PC OP IC Ex	1272	146	111	5558	43,8	127	80+	4000	2,8
Barat LED2x3800 C111 T840 PC/PC OP IC Ex	1272	146	111	7537	64,8	116	80+	4000	2,8
Barat LED1x3200 C113 T840 PC/PC OP IC Ex	1572	96	111	3473	27,3	127	80+	4000	2,6
Barat LED1x4700 C114 T840 PC/PC OP IC Ex	1572	96	111	4711	40,5	116	80+	4000	2,6
Barat LED2x3200 C116 T840 PC/PC OP IC Ex	1572	146	111	6947	54,7	127	80+	4000	3,3
Barat LED2x4700 C117 T840 PC/PC OP IC Ex	1572	146	111	9421	81,0	116	80+	4000	3,3

*Tolerance range for optical and electrical data: ±10%. Values apply to an ambient temperature of 25°C. NORTHCLIFFE LIGHTING is constantly developing and improving its products. The right is reserved to change any product specifications without prior notification

OPTIONS AVAILABLE ON REQUEST:

LED	EMERGENCY	CONNECTION
T830	EM3B ^{1 2}	5TB
T840		1LIN2.5
		3LIN2.5

1 EM options not applicable for models: C101, C102, C104, C105
2 Operating temperature range for Luminaires with EM option, °C: ta 0... +35

OP

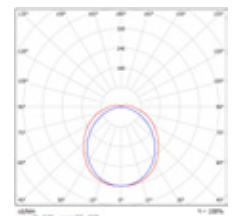



ANTI-VANDAL LUMINAIRES

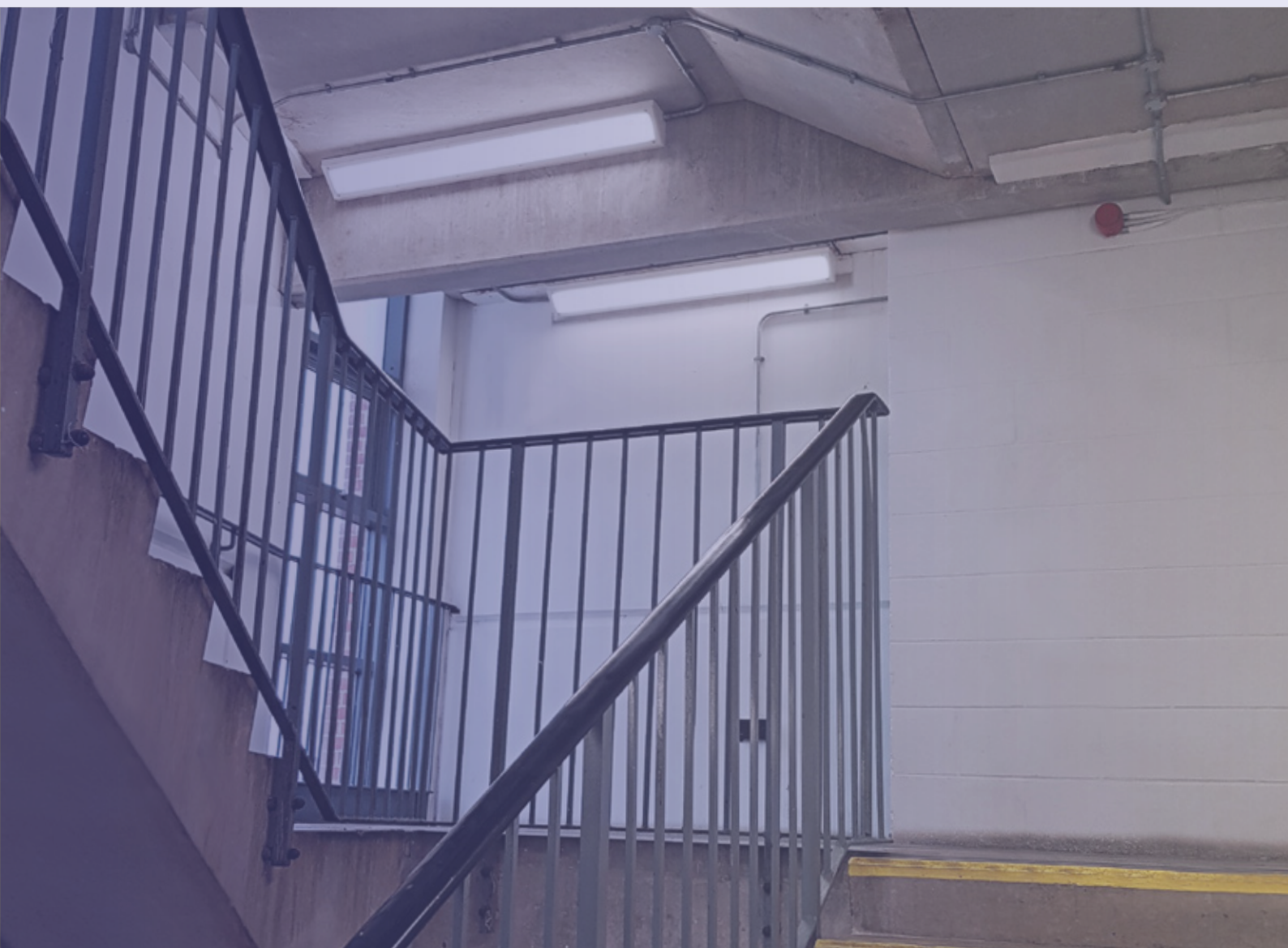

CAELUM R LED

Anti-vandal Luminaires



DESCRIPTION: **Recessed mounted anti-vandal LED luminaire**
Light distribution type: direct
Optical system: opal polycarbonate diffuser, UV stable, vandal resistant, frame with stainless-steel security screws
Housing: zinc-plated steel
Colour: white, RAL9010W

GENERAL DATA: **Mains voltage:** 220-240V, 0/50-60Hz
LED lifetime, h: 100000/L80B10
SDCM: 3
Protection class IEC: I
Ingress protection code: IP65
Mechanical impact resistance: IK10+
Protection symbol: D
Glow wire test, °C: 850
Operating temperature range, °C: ta -20...+40

INSTALLATION: In ceilings or walls with cut-out openings (mounting brackets included). Security bit to be ordered separately. Push-in terminal, 3x2x2.5mm²

ENVIRONMENT: Indoor/outdoor with roof

APPLICATION: Public place, underground passage, transport terminal, parking area, metro, prison, psychiatric hospital

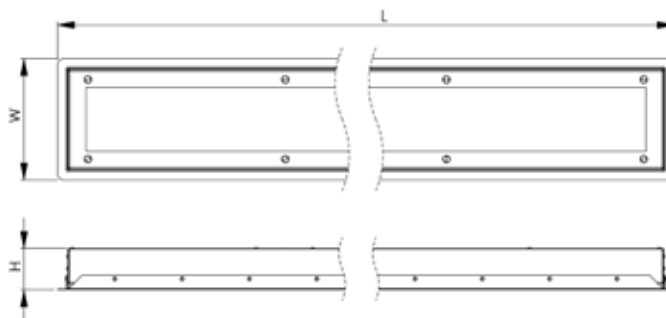

PRODUCT	LENGTH, mm	WIDTH, mm	HEIGHT, mm	CUT-OUT, mm	LUMINAIRE OUTPUT*, lm	SYSTEM POWER*, W	SYSTEM EFFICACY*, lm/W	CRI	CCT*, K	WEIGHT, kg
Caelum R LED1x1250 G529 T840 OP	410	180	65	395x165	1226	10,2	120	80+	4000	4,0
Caelum R LED1x1550 G530 T840 OP	410	180	65	395x165	1548	12,8	121	80+	4000	3,0
Caelum R LED1x1700 G531 T840 OP	690	180	65	675x165	1685	13,8	122	80+	4000	4,5
Caelum R LED1x2350 G532 T840 OP	690	180	65	675x165	2334	18,8	124	80+	4000	4,5
Caelum R LED1x2900 G533 T840 OP	690	180	65	675x165	2899	21,8	133	80+	4000	3,5
Caelum R LED1x2550 G534 T840 OP	970	180	65	955x165	2528	20,1	126	80+	4000	6,5
Caelum R LED1x3550 G535 T840 OP	970	180	65	955x165	3502	27,6	127	80+	4000	6,5
Caelum R LED1x4250 G536 T840 OP	970	180	65	955x165	4214	32,5	130	80+	4000	6,5
Caelum R LED1x3150 G537 T840 OP	1250	180	65	1235x165	3113	24,6	127	80+	4000	8,4
Caelum R LED1x4700 G538 T840 OP	1250	180	65	1235x165	4668	37,2	126	80+	4000	8,4
Caelum R LED1x5650 G539 T840 OP	1250	180	65	1235x165	5619	43,2	130	80+	4000	8,4
Caelum R LED1x3900 G540 T840 OP	1530	180	65	1515x165	3891	30,7	127	80+	4000	10,2
Caelum R LED1x5300 G541 T840 OP	1530	180	65	1515x165	5295	40,9	130	80+	4000	10,2
Caelum R LED1x5850 G542 T840 OP	1530	180	65	1515x165	5805	45,5	128	80+	4000	10,2
Caelum R LED1x7050 G543 T840 OP	1530	180	65	1515x165	7023	54,1	130	80+	4000	10,2

*Tolerance range for optical and electrical data: ±10%. Values apply to an ambient temperature of 25°C. NORTHCLIFFE LIGHTING is constantly developing and improving its products. The right is reserved to change any product specifications without prior notification

AVAILABLE ACCESSORIES:



Product: Security bit ART9109 SP10
Description: Security screw drill bit for 2-hole security fixings

OPTIONS AVAILABLE ON REQUEST:

LED	CONTROL GEAR	SENSORS	EMERGENCY	COLOUR
T830	DALI	MW ²	EM3B ^{3 4}	RAL
T840	COR ¹		EM3A ^{3 4}	
	COR1min ¹		EM3Atmin-25 ^{3 4}	
	COR30min ¹		EM3D ^{3 4}	

- 1 COR options not applicable for models: G529, G530
- 2 In outdoor environment frequently moving objects (eg. trees, bushes, flags) can impact MW sensor operation
- 3 EM options applicable for models from 600mm and longer
- 4 Operating temperature range for Luminaires with EM option, °C: ta 0... +35

OP

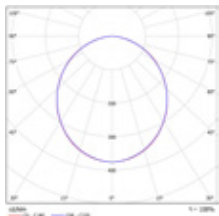

CAELUM S LED

Anti-vandal Luminaire



DESCRIPTION: **Surface mounted anti-vandal LED luminaire**
Light distribution type: direct
Optical system: opal polycarbonate diffuser, UV stable, vandal resistant, frame with stainless-steel security screws
Housing: zinc-plated steel
Colour: white, RAL9010W

GENERAL DATA: **Mains voltage:** 220-240V, 0/50-60Hz
LED lifetime, h: 100000/L80B10
SDCM: 3
Protection class IEC: I
Ingress protection code: IP65
Mechanical impact resistance: IK10+
Protection symbol: D
Glow wire test, °C: 850
Operating temperature range, °C: ta -20...+40

INSTALLATION: On the ceiling (security bit to be ordered separately). Push-in terminal, 3x2x2.5mm²

ENVIRONMENT: Indoor/outdoor with roof

APPLICATION: Public place, underground passage, transport terminal, parking area, metro, prison, psychiatric hospital

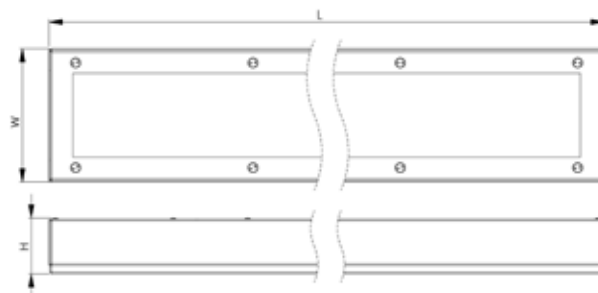

PRODUCT	LENGTH, mm	WIDTH, mm	HEIGHT, mm	LUMINAIRE OUTPUT*, lm	SYSTEM POWER*, W	SYSTEM EFFICACY*, lm/W	CRI	CCT*, K	WEIGHT, kg
Caelum S LED1x1250 G499 T840 OP	380	150	65	1226	10,2	120	80+	4000	3,0
Caelum S LED1x1550 G500 T840 OP	380	150	65	1548	12,8	121	80+	4000	3,0
Caelum S LED1x1700 G501 T840 OP	660	150	65	1685	13,8	122	80+	4000	3,5
Caelum S LED1x2350 G502 T840 OP	660	150	65	2334	18,8	124	80+	4000	3,5
Caelum S LED1x2900 G503 T840 OP	660	150	65	2899	21,8	133	80+	4000	3,5
Caelum S LED1x2550 G504 T840 OP	940	150	65	2528	20,1	126	80+	4000	5,5
Caelum S LED1x3550 G505 T840 OP	940	150	65	3502	27,6	127	80+	4000	5,5
Caelum S LED1x4250 G506 T840 OP	940	150	65	4214	32,5	130	80+	4000	5,5
Caelum S LED1x3150 G507 T840 OP	1220	150	65	3113	24,6	127	80+	4000	7,4
Caelum S LED1x4700 G508 T840 OP	1220	150	65	4668	37,2	126	80+	4000	7,4
Caelum S LED1x5650 G509 T840 OP	1220	150	65	5619	43,2	130	80+	4000	7,4
Caelum S LED1x3900 G510 T840 OP	1500	150	65	3891	30,7	127	80+	4000	9,2
Caelum S LED1x5300 G511 T840 OP	1500	150	65	5295	40,9	130	80+	4000	9,2
Caelum S LED1x5850 G512 T840 OP	1500	150	65	5805	45,5	128	80+	4000	9,2
Caelum S LED1x7050 G513 T840 OP	1500	150	65	7023	54,1	130	80+	4000	9,2

*Tolerance range for optical and electrical data: ±10%. Values apply to an ambient temperature of 25°C. NORTHCLIFFE LIGHTING is constantly developing and improving its products. The right is reserved to change any product specifications without prior notification

AVAILABLE ACCESSORIES:



Product: Security bit ART9109 SP10
Description: Security screw drill bit for 2-hole security fixings

OPTIONS AVAILABLE ON REQUEST:

LED	CONTROL GEAR	SENSORS	EMERGENCY	COLOUR
T830	DALI	MW ²	EM3B ^{3 4}	RAL
T840	COR ¹		EM3A ^{3 4}	
	COR1min ¹		EM3Atmin-25 ^{3 4}	
	COR30min ¹		EM3D ^{3 4}	

- 1 COR options not applicable for models: G499, G500
- 2 In outdoor environment frequently moving objects (eg. trees, bushes, flags) can impact MW sensor operation
- 3 EM options applicable for models from 600mm and longer
- 4 Operating temperature range for Luminaires with EM option, °C: ta 0... +35

OP

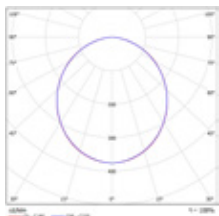

CAELUM A LED

Anti-vandal Luminaires



DESCRIPTION: **Corner-mounted anti-vandal LED luminaire**
Light distribution type: direct
Optical system: opal polycarbonate diffuser, UV stable, vandal resistant, frame with stainless-steel security screws
Housing: zinc-plated steel
Colour: white, RAL9010W

GENERAL DATA: **Mains voltage:** 220-240V, 0/50-60Hz
LED lifetime, h: 100000/L80B10
SDCM: 3
Protection class IEC: I
Ingress protection code: IP65
Mechanical impact resistance: IK10+
Protection symbol: D
Glow wire test, °C: 850
Operating temperature range, °C: ta -20...+40

INSTALLATION: In the corner (security bit to be ordered separately). Push-in terminal, 3x2x2.5mm²

ENVIRONMENT: Indoor/outdoor with roof

APPLICATION: Public place, underground passage, transport terminal, parking area, metro, prison, psychiatric hospital

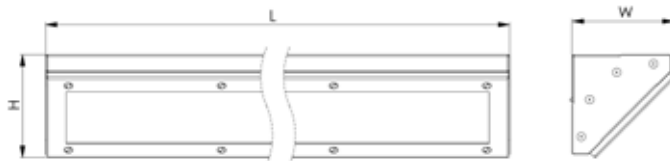

PRODUCT	LENGTH, mm	WIDTH, mm	HEIGHT, mm	LUMINAIRE OUTPUT*, lm	SYSTEM POWER*, W	SYSTEM EFFICACY*, lm/W	CRI	CCT*, K	WEIGHT, kg
Caelum A LED1x1250 G514 T840 OP	380	135	135	1226	10,2	120	80+	4000	3,0
Caelum A LED1x1550 G515 T840 OP	380	135	135	1548	12,8	121	80+	4000	3,0
Caelum A LED1x1700 G516 T840 OP	660	135	135	1685	13,8	122	80+	4000	3,5
Caelum A LED1x2350 G517 T840 OP	660	135	135	2334	18,8	124	80+	4000	3,5
Caelum A LED1x2900 G518 T840 OP	660	135	135	2899	21,8	133	80+	4000	3,5
Caelum A LED1x2550 G519 T840 OP	940	135	135	2528	20,1	126	80+	4000	5,5
Caelum A LED1x3550 G520 T840 OP	940	135	135	3502	27,6	127	80+	4000	5,5
Caelum A LED1x4250 G521 T840 OP	940	135	135	4214	32,5	130	80+	4000	5,5
Caelum A LED1x3150 G522 T840 OP	1220	135	135	3113	24,6	127	80+	4000	7,4
Caelum A LED1x4700 G523 T840 OP	1220	135	135	4668	37,2	126	80+	4000	7,4
Caelum A LED1x5650 G524 T840 OP	1220	135	135	5619	43,2	130	80+	4000	7,4
Caelum A LED1x3900 G525 T840 OP	1500	135	135	3891	30,7	127	80+	4000	9,2
Caelum A LED1x5300 G526 T840 OP	1500	135	135	5295	40,9	130	80+	4000	9,2
Caelum A LED1x5850 G527 T840 OP	1500	135	135	5805	45,5	128	80+	4000	9,2
Caelum A LED1x7050 G528 T840 OP	1500	135	135	7023	54,1	130	80+	4000	9,2

*Tolerance range for optical and electrical data: ±10%. Values apply to an ambient temperature of 25°C. NORTHCLIFFE LIGHTING is constantly developing and improving its products. The right is reserved to change any product specifications without prior notification

AVAILABLE ACCESSORIES:



Product: Security bit ART9109 SP10
Description: Security screw drill bit for 2-hole security fixings



Product: BLANK Caelum A LED
Description: Blank part kit for connecting luminaires in-line and securing cables between luminaires, 1pcs

OPTIONS AVAILABLE ON REQUEST:

LED	CONTROL GEAR	SENSORS	EMERGENCY	COLOUR
T830	DALI	MW ²	EM3B ³ 4	RAL
T840	COR ¹		EM3A ³ 4	
	COR1min ¹		EM3Atmin-25 ³ 4	
	COR30min ¹		EM3D ³ 4	

- 1 COR options not applicable for models: G514, G515
- 2 In outdoor environment frequently moving objects (eg. trees, bushes, flags) can impact MW sensor operation
- 3 EM options applicable for models from 600mm and longer
- 4 Operating temperature range for Luminaires with EM option, °C: ta 0... +35

OP

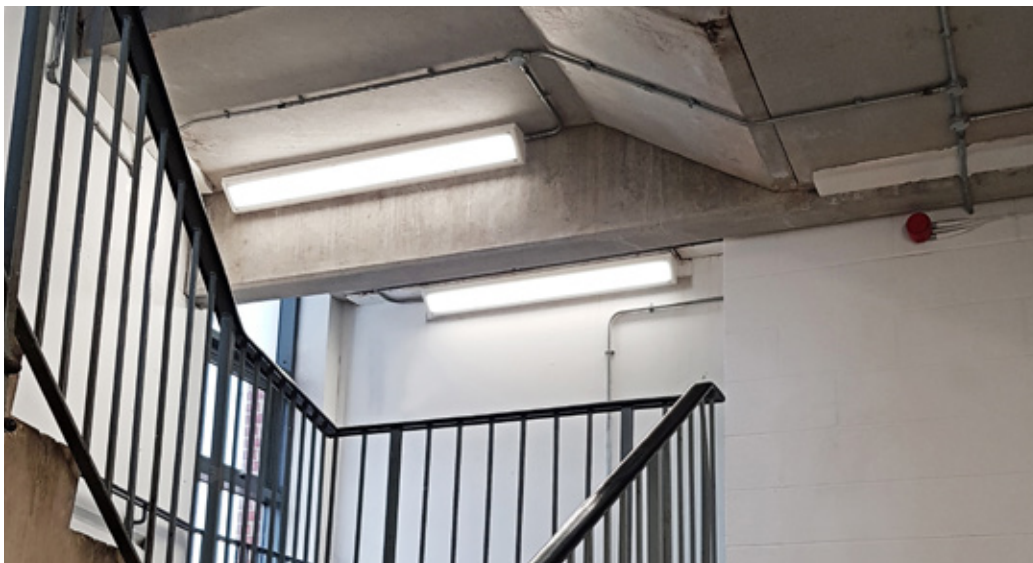
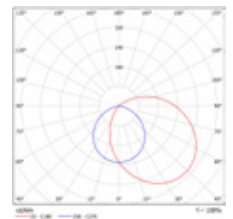

CAELUM W LED

Anti-vandal Luminaires

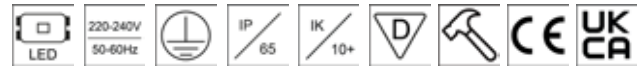

DESCRIPTION: **Wall-mounted anti-vandal LED luminaire**
Light distribution type: direct
Optical system: opal polycarbonate diffuser, UV stable, vandal resistant, frame with stainless-steel security screws
Housing: zinc-plated steel
Colour: white, RAL9010W

GENERAL DATA: **Mains voltage:** 220-240V, 0/50-60Hz
LED lifetime, h: 100000/L80B10
SDCM: 3
Protection class IEC: I
Ingress protection code: IP65
Mechanical impact resistance: IK10+
Protection symbol: D
Glow wire test, °C: 850
Operating temperature range, °C: ta -20...+40

INSTALLATION: On the wall (security bit to be ordered separately). Push-in terminal, 3x2x2.5mm²

ENVIRONMENT: Indoor/outdoor with roof

APPLICATION: Public place, underground passage, transport terminal, parking area, metro, prison, psychiatric hospital

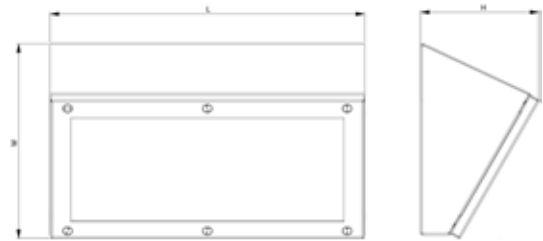

PRODUCT	LENGTH, mm	WIDTH, mm	HEIGHT, mm	LUMINAIRE OUTPUT*, lm	SYSTEM POWER*, W	SYSTEM EFFICACY*, lm/W	CRI	CCT*, K	WEIGHT, kg
Caelum W LED1x1250 G544 T840 OP	380	110	150	1208	10,2	118	80+	4000	3,0
Caelum W LED1x1550 G545 T840 OP	380	110	150	1526	12,8	119	80+	4000	3,0

*Tolerance range for optical and electrical data: ±10%. Values apply to an ambient temperature of 25°C. NORTHCLIFFE LIGHTING is constantly developing and improving its products. The right is reserved to change any product specifications without prior notification

AVAILABLE ACCESSORIES:



Product: Security bit ART9109 SP10
Description: Security screw drill bit for 2-hole security fixings

OPTIONS AVAILABLE ON REQUEST:

LED	CONTROL GEAR	SENSORS	COLOUR
T830	DALI	MW ¹	RAL
T840	ASW(IP65)		
	ASW(IP40)		

OP

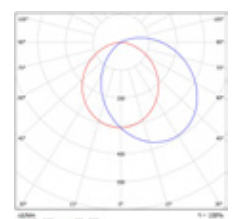

¹ In outdoor environment frequently moving objects (eg. trees, bushes, flags) can impact MW sensor operation

EMERGENCY LIGHTING





EMS MINI – EMERGENCY MONITORING SYSTEM

Product Group: Emergency Lighting



DESCRIPTION: The EMS MINI system is a modern, compact solution designed for the monitoring of emergency luminaires with unique addresses installed in small-size buildings and facilities. The system offers the possibility to supervise up to 500 emergency luminaires equipped with EMS-type power supply sources. The main advantages of the EMS MINI control unit are its compact size and the possibility to mount it on a DIN-3 standard rail (TH35). The system is simplified but not deprived of the most important functionalities from the user's point of view. Each control unit is equipped with an RS485 connection for the communication bus, an RJ45 connector, four LEDs indicating the current status of the system, three function keys which can be programmed in the control unit, a reset button and a service pin to assign a unique IP address to the unit. Additionally, the control unit has two potential-free input contacts and two outputs. Communication with EMS emergency luminaires is provided by means of an RS485 standard communication bus. A single bus may not exceed 1200 m when linear topology is used. The communication with luminaires is continuous.

- FEATURES:**
- Monitoring of up to 500 emergency luminaires.
 - Maximum length of each single bus line 1200m.
 - System status indicators.
 - TH35 (DIN-3) rail mounted.
 - Three programmable function keys.
 - Two potential-free inputs (current loops).
 - Two outputs (to control external relays).
 - Internal memory to store emergency lighting system reports, compliant with EN 50172.
 - Mains mode, configured from the control unit.
 - Testing of individual luminaires or groups of luminaires.
 - Internal battery for uninterruptible operation.
 - RJ45 connector for direct communication with any computer via Ethernet.
 - Individually programmable IP address.
 - System status preview using any web browser.
 - Continuous communication with luminaires installed in the system.
 - System management and visualization by using dedicated EMS smart software.

**For safety reasons, the control unit communicates with luminaires continuously and has a built-in powers supply source. All EMS systems are manufactured in compliance with applicable European standards*

Lighting fittings working under the system have unique addresses and are connected to Emergency system control unit with a communication cable. The fittings communicate with the central unit reporting any abnormalities which are signaled on the central unit display with LED diodes placed on the central unit panel. Each fitting connected to the system may have an individual description in the control unit. When abnormalities, related to the operation of a fitting, occur, information about the type of abnormality and the location of the fitting appears on the display of the control unit. The system allows manual testing of a single fitting. Central unit's software allows dividing the fittings into groups which enables one to run tests only on chosen groups of fittings. Apart from manual tests, the following auto-tests are carried out:

TEST A – A SHORT TEST, RECOMMENDED EVERY 30 DAYS (LST-EN 50172) – CHECKS THE FOLLOWING PARAMETERS:	TEST B – A LONG TEST RECOMMENDED EVERY 360 DAYS (LST-EN 50172) – CHECKS THE FOLLOWING PARAMETERS:
<ul style="list-style-type: none"> ▪ Enforcing emergency operation of the fitting for 5 minutes. ▪ Control of battery power discharge. ▪ Control of minimum voltage of battery. 	<ul style="list-style-type: none"> ▪ Enforcing emergency operation of the fitting for the time programmed for each fitting (1, 2, 3 h). ▪ Control of battery power discharge. ▪ Control of minimum voltage of battery. ▪ Control of the condition of battery.

The frequency of running tests A and B may be programmed according to the needs of the user. There is a possibility of programming the tests with exact dates, when they should be carried out. Long tests B should be run when the premises are not used within 24 hours after finishing the test. This time is needed for the recharging of the batteries discharged during the long test. Test results are stored in the memory of the central unit.

SYSTEM COMPONENTS:



- EMS address module. Features:**
- Compatible with LED light sources.
 - Switching to emergency mode.
 - LiFePO4 battery.
 - Battery charge indicator.
 - Luminaire status indicator.



- EMS smart platform. Features:**
- System status monitoring.
 - System programming.
 - Event log viewing.
 - Test function.
 - Possibility to upload floor plans of the building/facility.

SYSTEM TOPOLOGY:

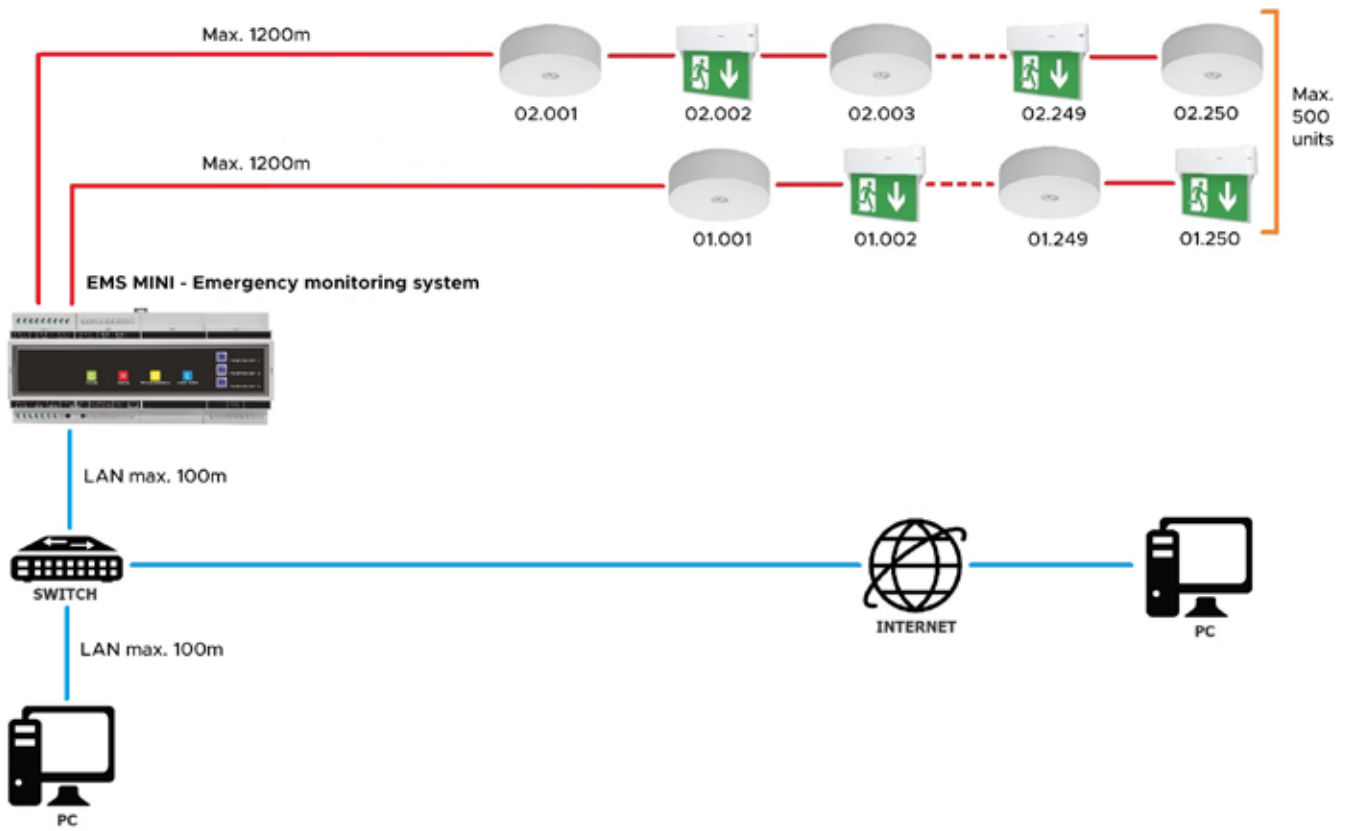



EMS – EMERGENCY MONITORING SYSTEM

Product Group: Emergency Lighting



DESCRIPTION:

The EMS system is the latest and the most advanced monitoring system designed to control independent luminaires of emergency and escape route lighting systems. It is designed to be used in medium-to-large facilities and buildings. Each control unit can handle up to 4,000 luminaires using MP-250 power submodules. The submodules communicate with the EMS control unit via LAN. The use of LAN also enables communication between individual submodules. The EMS system is equipped with a touch panel and an intuitive graphic menu to enable quick and easy system configuration without the need for using EMS smart platform. Thanks to introduced technical solutions polarity does not need to be observed any more while connecting a communication bus to the following system components:

- EMS control unit.
- MP-250 power submodules.
- EMS address modules.

Each EMS address module is assigned an individual number/address. The addresses are factory-assigned, so an addressing unit is not required for installation, setting up or maintenance work. Communication with EMS emergency luminaires is provided by means of an RS485 standard communication bus. A single bus may not exceed 1200 m when linear topology is used. The communication with luminaires is continuous.

FEATURES:

- Touch screen control unit.
- Unique addresses of luminaires.
- Factory-assigned module addresses.
- No need for an addressing unit.
- Intuitive graphical user interface.
- No need to keep the polarity of communication cables connection.
- Inbuilt four potential-free inputs and outputs.
- Remote access via web browser.
- Monitoring of up to 750 luminaires per control unit (3 logical buses: 01, 02 and 03 - each one with 2 physical channels).
- Possibility to expand the control system up to 4,000 luminaires by using additional external submodules.
- System status indication.
- Compatibility LED light sources.
- Internal battery for uninterruptible operation.
- Automatic performance of tests.
- Event log.
- Possibility to divide the luminaires for logic groups.
- Mains mode for selected luminaires/groups.
- System management and visualization using of dedicated EMS smart software.
- BACnet standard, enabling compatibility of the EMS with Building Management Systems (BMS).

**For safety reasons, the control unit communicates with luminaires continuously and has a built-in powers supply source. All EMS systems are manufactured in compliance with applicable European standards*

Lighting fittings working under the system have unique addresses and are connected to Emergency system control unit with a communication cable. The fittings communicate with the central unit reporting any abnormalities which are signaled on the central unit display with LED diodes placed on the central unit panel. Each fitting connected to the system may have an individual description in the control unit. When abnormalities, related to the operation of a fitting, occur, information about the type of abnormality and the location of the fitting appears on the display of the control unit. The system allows manual testing of a single fitting. Central unit's software allows dividing the fittings into groups which enables one to run tests only on chosen groups of fittings. Apart from manual tests, the following auto-tests are carried out:

TEST A – A SHORT TEST, RECOMMENDED EVERY 30 DAYS (LST-EN 50172) – CHECKS THE FOLLOWING PARAMETERS:

- Enforcing emergency operation of the fitting for 5 minutes.
- Control of battery power discharge.
- Control of minimum voltage of battery.

TEST B – A LONG TEST RECOMMENDED EVERY 360 DAYS (LST-EN 50172) – CHECKS THE FOLLOWING PARAMETERS:

- Enforcing emergency operation of the fitting for the time programmed for each fitting (1, 2, 3 h).
- Control of battery power discharge.
- Control of minimum voltage of battery.
- Control of the condition of battery.

The frequency of running tests A and B may be programmed according to the needs of the user. There is a possibility of programming the tests with exact dates, when they should be carried out. Long tests B should be run when the premises are not used within 24 hours after finishing the test. This time is needed for the recharging of the batteries discharged during the long test. Test results are stored in the memory of the central unit.

SYSTEM COMPONENTS:



MP-250 Power module. Features:

- Submodules mounted on a DIN-3 rail (TH35).
- Monitoring of up to 250 luminaires.
- Ethernet connection for LAN communication.
- Service pin and Reset button.
- Freely programmable IP address.
- Built-in uninterruptible power supply unit.

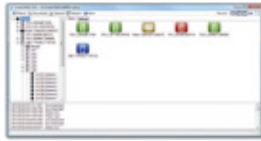

EMS address module. Features:

- Compatible with LED light sources.
- Switching to emergency mode.
- LiFePO4 battery.
- Battery charge indicator.
- Luminaire status indicator.

EMS smart platform. Features:

- System status monitoring.
- System programming.
- Event log viewing.
- Test function.
- Possibility to upload floor plans of the building/facility.

SYSTEM TOPOLOGY:

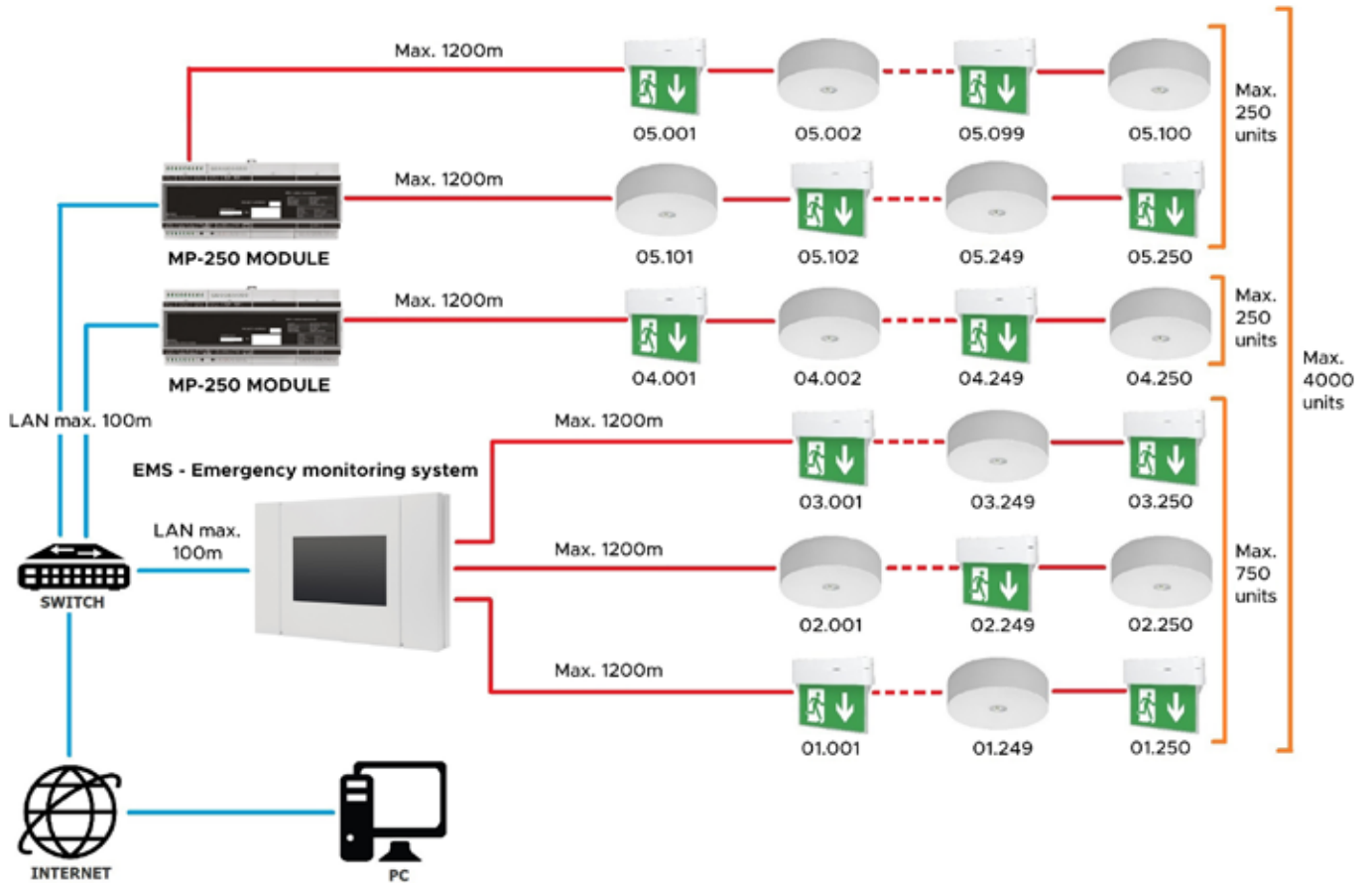



CEBLV – CENTRAL BATTERY LOW VOLTAGE SYSTEM

Product Group: Emergency Lighting



DESCRIPTION:

Central battery system CEBLV is a high-tech device created to power and monitor emergency lighting in buildings of small and medium size and in closed fire zones. The system can work with up to 160 LED luminaires supplied by SELV 48V (Safety Extra-Low Voltage) and was designed in Smart technology.

The application of the SELV voltage ensures high level of safety of servicing of the system and its elements compliant with the currently valid regulations. Small dimensions of the central unit enable the installation of the system in places where one cannot fit a large-size central battery system. The CEBLV central unit is equipped with a big touch panel enabling both the current reading of the status of the system, circuits and fittings and the introduction of all settings and parameters of the system with the use of the user interface. Statuses are displayed in both graphic and text form. Using the central unit one can assign a name to the fitting that will clearly help to identify the fittings installed in the system. Using the central unit one can program and freely configure the emergency fittings in constant, non-constant, switching and switching-dimming modes as well as night work mode. The system has its own IP address and RJ45 slot which is used for direct connection to Ethernet. With a built-in WEB module, you can directly access the system from any computer and print the event log by using any web browser. Additionally, the system has an input and an SD card that allows to record and upload system settings (back-up) and the record reports of the Event Log in accordance with EN 50172.

FEATURES:

- Power supply and monitoring up to 160 individual LED fittings in CEBLV smart technology.
- Up to 8 independent circuits, which make it possible to connect up to 20 fittings per circuit. The maximum load of a single circuit is 2.5A.
- Safe supply SELV 48V.
- Smart technology – any mode of a fitting.
- Easy to read, big LCD touch screen.
- Easy and intuitive menu with simple icons.
- Automatic or manual activation of short or long tests of the whole system.
- Automatic detection and adding of the fittings to the system.
- Built-in WEB module.
- Built-in clock and calendar with DST adjustment and synchronization with a time server.
- Programming and configuration of the fittings directly from the system.
- Assigning names to luminaires.
- Assigning design addresses to luminaires.
- Communication with luminaires through the power supply cable.
- SD slot and SD card for recording, transmission and printing emergency lighting reports from any PC, in accordance with EN 50172.
- Possibility to store the system settings (back – up) on SD card.
- Contained security light mode (night operation).
- Testing of each fitting separately as well as group of fittings.
- Internal rechargeable battery with a designed life of 10 years.
- RJ45 slot for direct connection to Ethernet.
- Individual IP address.
- Preview of the system via any web browser.
- Works with any BMS (Building Management System) by using the module of potential-free contacts or a CAN-bus.
- Unlimited grouping of systems and joint supervision by smart touch screen controller.
- Control menu with language selection.
- Management and visualization of the system using a dedicated CEBLV smart platform.

**For safety reasons, the control unit communicates with luminaires continuously and has a built-in powers supply source. All EMS systems are manufactured in compliance with applicable European standards*

CEBLV unit can be supplied from a 230V AC or a 216V DC power source. As a result, the unit can be connected to a central battery system as a substation without installing internal batteries. This functionality enables the system to be used in facilities where a central battery system is required, but a safe voltage must also be ensured in areas where there is a risk of electric shock.

CEBLV TOPOLOGY:

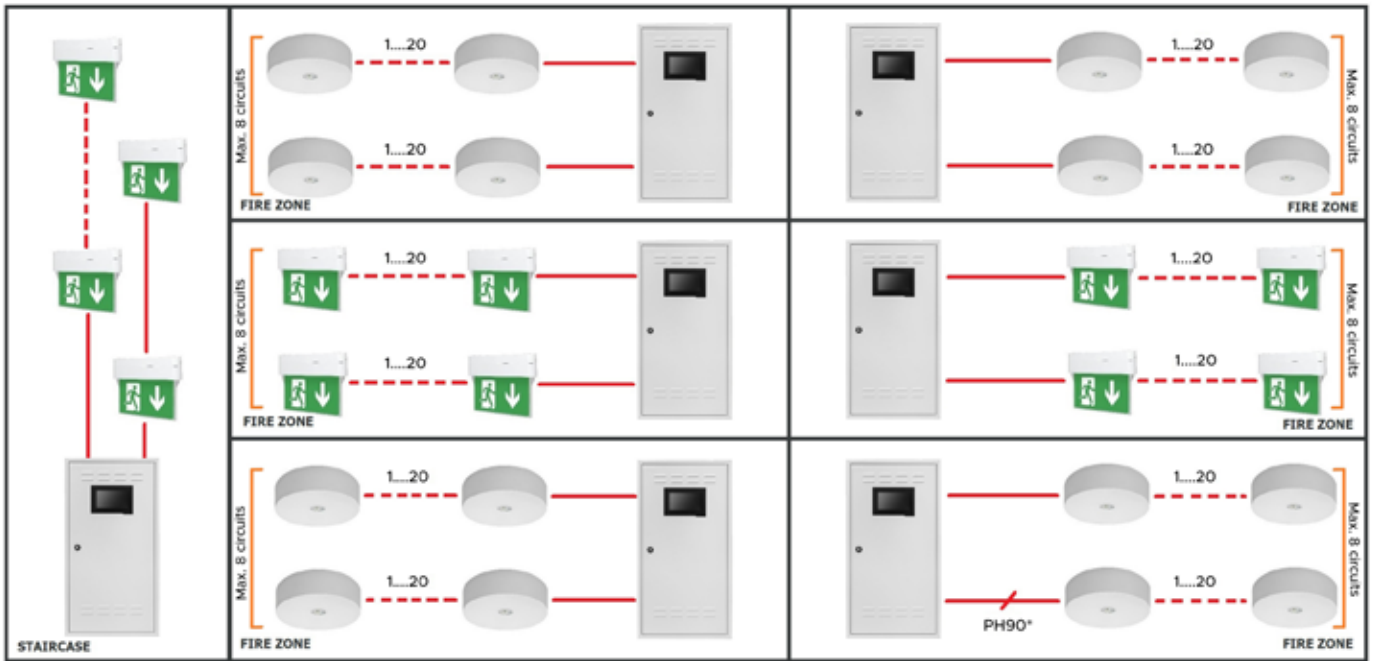

*National regulations apply

Decentralized system:

- Main station failure.
- Cable failure: main station – substation.
- Damaged insulation of the branch circuit.
- No central system.
- Each system is independent; the failure is limited to one fire zone.
- Negligible fire hazard (SELV).

SMART – SWITCHING METHOD AND REVISION TECHNOLOGY

A conventional installation requires that the operating mode of each circuit is specified at the design stage. Subsequent modifications or errors may cause extra costs. In order to eliminate such drawbacks, NORTHCLIFFE has introduced a new technology with automatic monitoring and individual control of each luminaire in a system.

**Switching
Method
And
Revision
Technology**

or SMART for short. This technology enables installation of luminaires- in a common circuit- operating in four modes: continuous, intermittent, switched and dimmed. Programming and monitoring of the luminaires are provided via power supply cables. The applied technology does not require the use of special communication cables. It can be implemented if appropriate address modules are installed in the luminaires. The modules are fitted as standard in all luminaires designed to work within CEBLV central battery system. Each address module is assigned with a unique address which enables its accurate identification in the system.

A SMART TECHNOLOGY SYSTEM LAYOUT:

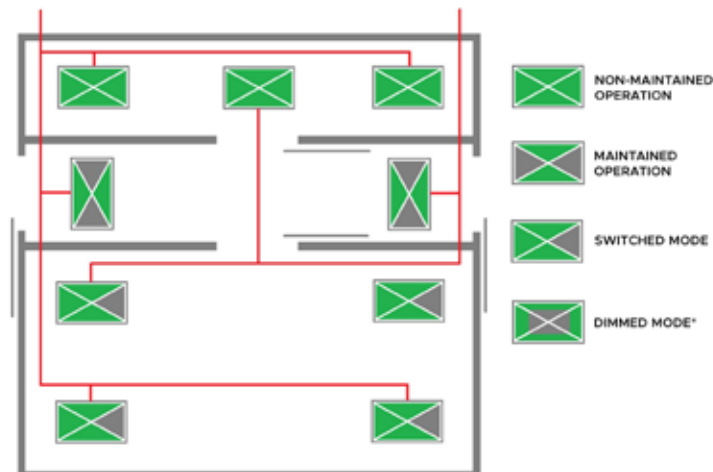

*CEBLV systems only

SMART advantages:

- Luminaires operating in different modes can be installed within a single circuit.
- Less cable is required.
- Smaller number of circuits.
- Lower installation costs.
- Operating modes of the luminaires can be changed at any time.

SMART touch controller

The SMART touch controller enables remote control and monitoring of any number of units from a single location. The controller provides remote monitoring, configuration and reading of events for each connected CEBLV unit.

Features:

- Functional test/Battery test activation for each device.
- Global system locking/unlocking.
- Password-protected access to the controller.
- Checking the status of individual systems.
- Full remote configuration of all systems.
- Active list of systems enabling quick status checks.
- Four globally configured inputs and outputs.
- Standard fitted Ethernet interface to enable remote control and visualization of the system via a web browser.

CEBLV WITH SMART TOUCH CONTROLLER TOPOLOGY:

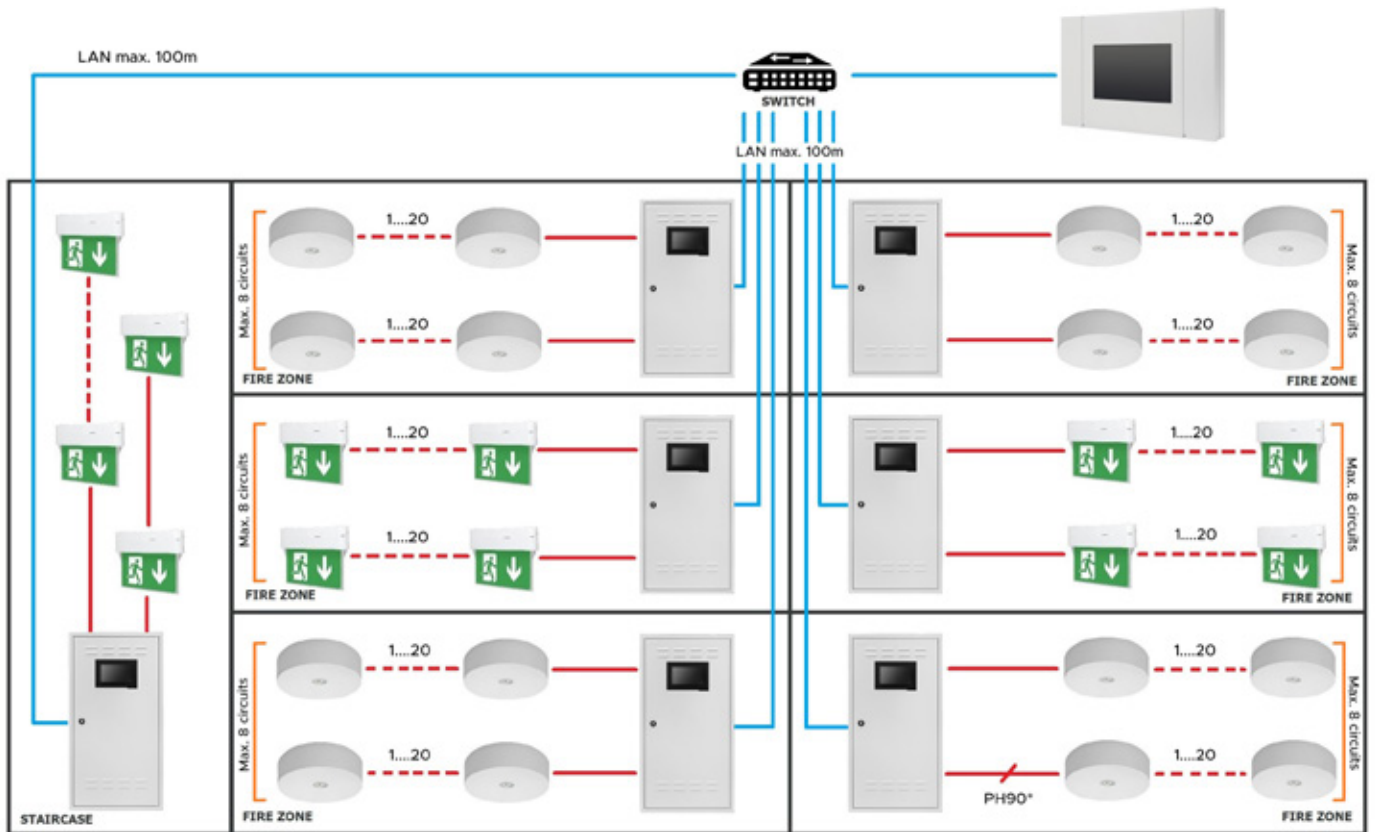





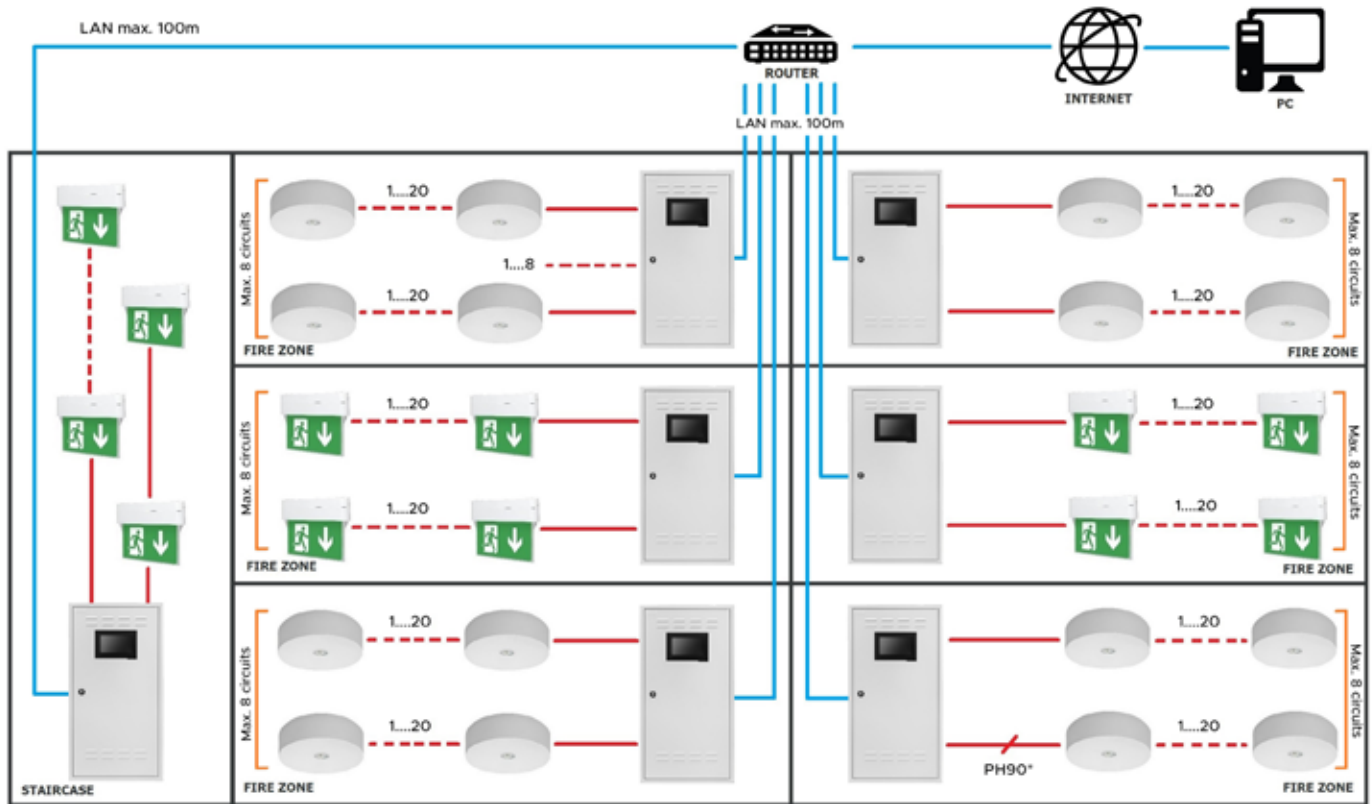

The CEBLV system is equipped with an Ethernet port as standard. The connection enables remote checking of the status and setting up of the system via FIRE ZONE a dedicated website. This solution provides the user with the ability to control and monitor the system from a computer with a web browser installed. To check the system status using a computer, the user only needs to log in to the structural network of the facility or building where the CEBLV is installed. Each unit, circuit and luminaire can be monitored via the Internet. The access to the dedicated website is password protected.

CEBLV REMOTE CONTROL TOPOLOGY:



LIST OF CABINETS:

TECHNICAL SPECIFICATIONS:	CEBLV-7.2 AH	CEBLV-12 AH	CEBLV-18 AH	CEBLV-26 AH	CEBLV-33 AH	CEBLV-40 AH
Supply voltage: AC 230 ±10%, 50/60Hz or DC 216 V ±20% AC protection: T8A/250V, 5x20 mm Circuit protection: T4A/250V, 5x20 mm DC protection: T20A/440V, 6,3x32 mm Max cross-section of mains power connector: 2,5mm ² Protection class: I Ingress protection: IP20 Output voltage: 48V DC ±20% Working temperature: -5...30°C						
Dimensions	650x350x150	650x350x150	870x460x220	870x460x220	870x460x220	870x460x220
Battery capacity	7,2 Ah	12 Ah	18 Ah	26 Ah	33 Ah	40 Ah
No of batteries	4	4	4	4	4	4
Maximum power						
1 h	166 W	280 W	423 W	600 W	734 W	890 W
3 h	64 W	110 W	168 W	241 W	309 W	375 W
8 h	25 W	46 W	72 W	106 W	137 W	167 W
Number of circuits	4	4/8	8	8	8	8
Max. cross-section of circuit connector	2,5mm ²	2,5mm ²	2,5mm ²	2,5mm ²	2,5mm ²	2,5mm ²
Max circuit load*	120 W	120 W	120 W	120 W	120 W	120 W
Cable grommets	24 X M20 or MC 35 multi-line cable grommet	24 X M20 or MC 35 multi-line cable grommet	MC 35 multi-line cable grommet	MC 35 multi-line cable grommet	MC 35 multi-line cable grommet	MC 35 multi-line cable grommet
Weight	18,5 kg	25,5 kg	45,0 kg	52,3 kg	60,0 kg	72,5 kg

*Loss of power in luminaire supply cable and modules not considered



NOVA SP LED

Emergency Lighting



DESCRIPTION: **Recessed mounted LED emergency escape luminaire**
Optical system: open area lenses
Housing: polycarbonate
Colour: white
Battery charging time: 24 hours
Battery: LiFePO4, deep discharge protection

GENERAL DATA: **Mains voltage:** 220-240V, 50-60Hz
LED lifetime, h: 50000/L70B50
SDCM: 5
Protection class IEC: II
Ingress protection code: IP20
Mechanical impact resistance: IK05
Operating temperature range, °C: ta 0...+40

INSTALLATION: In ceilings (ceiling thickness 1-13mm) with cut-out openings (mounting brackets included). Push-in terminal, 2x1x1.5mm²

ENVIRONMENT: Indoor

APPLICATION: Escape route lighting

PRODUCT	LENGTH, mm	WIDTH, mm	HEIGHT, mm	CUT-OUT, mm	ILLUMINATION MODE	EMERGENCY OPERATING TIME, H	POWER IN EMERGENCY MODE, W*	CRI	CCT*, K	WEIGHT, kg
Nova SP 3HLED D591 LOA	40	40	22	34	NM	3	2	70+	4000	0,3

*NM - non-maintained, system power and output indicates data in emergency mode, tolerance range for optical and electrical data: ±10%, values apply to an ambient temperature of 25°C

Note - recessed mounted in steel body

LOA

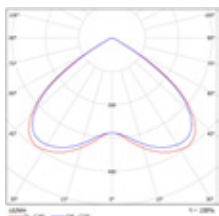

ARA R LED

Emergency Lighting



DESCRIPTION: **Recessed mounted LED emergency escape luminaire**
Light distribution type: direct
Optical system: lenses
Housing: polycarbonate
Colour: white; light grey; black
Battery charging time: 24 hours (12 hours optional: AUT)
Battery: NiCd (LiFePO4 optional: AUT), deep discharge protection

GENERAL DATA: **Mains voltage:** 220-240V, 50-60Hz
LED lifetime, h: 70000/L80B10
SDCM: 5
Protection class IEC: II
Ingress protection code: IP65/20
Mechanical impact resistance: IK08
Operating temperature range, °C: ta 0...+40 (CEBLED ta -25...+50)

INSTALLATION: In ceilings with cut-out openings (mounting brackets included). Push-in terminal, 3x2x2.5mm². Electronic gear and battery package installed in a separate box

ENVIRONMENT: Indoor

APPLICATION: Escape route lighting

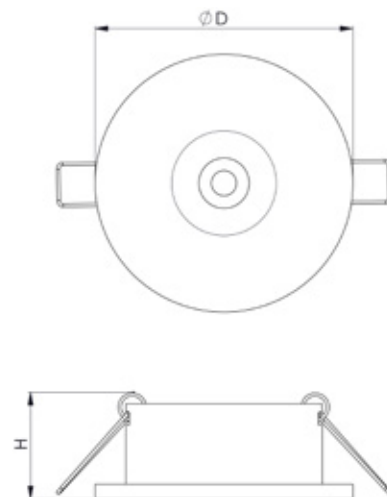

PRODUCT	DIAMETER, mm	HEIGHT, mm	CUT-OUT, mm	ILLUMINATION MODE	EMERGENCY OPERATING TIME, H	LUMINAIRE OUTPUT*, lm	POWER IN EMERGENCY MODE, W*	CRI	CCT*, K	WEIGHT, kg
Ara R 1HLED C364 LER IP65	100	37	83	NM	1	180	1	80+	6000	0,6
Ara R 3HLED C365 LER IP65	100	37	83	NM	3	180	1	80+	6000	0,7
Ara R 1PLED C366 LER IP65	100	37	83	M/NM	1	180	1	80+	6000	0,6
Ara R 3PLED C367 LER IP65	100	37	83	M/NM	3	180	1	80+	6000	0,7
Ara R CEBLED C368 LER IP65	100	37	83	CEB	x	190	1	80+	6000	0,6
Ara R 1PLED C371 LER IP65	100	37	83	M/NM	1	400	3	80+	6000	0,7
Ara R 3PLED C372 LER IP65	100	37	83	M/NM	3	400	3	80+	6000	0,7
Ara R CEBLED C373 LER IP65	100	37	83	CEB	x	460	3	80+	6000	0,6
Ara R 1PLED C376 LER IP65	100	37	83	M/NM	1	785	6	80+	6000	0,8
Ara R 3PLED C377 LER IP65	100	37	83	M/NM	3	785	6	80+	6000	1,1
Ara R CEBLED C378 LER IP65	100	37	83	CEB	x	785	6	80+	6000	0,8

*M - maintained (with an option of connecting as non-maintained), NM - non-maintained, CEB maintained, system power and output indicates data in emergency mode, tolerance range for optical and electrical data: ±10%, values apply to an ambient temperature of 25°C

OPTIONS AVAILABLE ON REQUEST:

EMERGENCY		
DALI ¹	LEW	CEB
LER	LOU	CLV
LOA	AUT	EMS ²

1 DALI option is applicable for models: C366, C367, C371, C372, C376, C377

2 EMS option is applicable for models: C366, C367, C371, C372, C376, C377

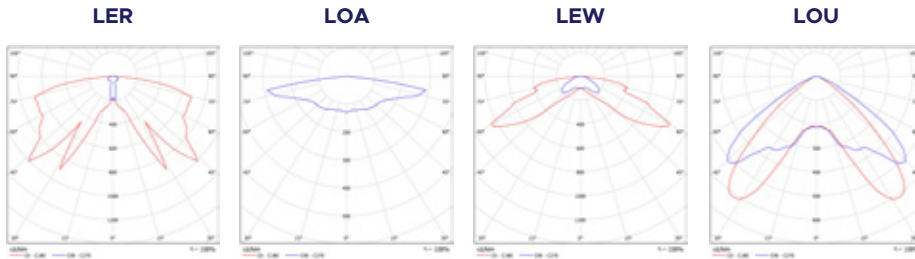

PHOTOMETRY OF LER / LOA

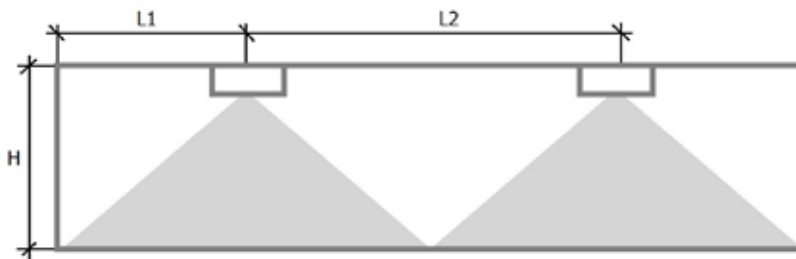

L1 - distance from the wall to the first fixture
L2 - distance between fixtures
H - height of the ceiling

LER optic for corridor route illumination:

LER - 1W/190lm min. 1lx			LER - 3W/460lm min. 1lx			LER - 6W/785lm min. 0.5lx		
H, m	L1, m	L2, m	H, m	L1, m	L2, m	H, m	L1, m	L2, m
2,5	6,0	15,0	2,5	8,0	20,0	2,5	10,0	24,5
3,0	6,5	16,0	3,0	8,5	21,5	3,0	11,0	27,0
3,5	6,5	17,0	3,5	9,0	23,0	3,5	11,5	28,5
4,0	7,0	18,0	4,0	9,5	24,5	4,0	12,0	31,5
4,5	7,5	18,5	4,5	10,0	25,5	4,5	12,5	32,5
5,0	7,0	18,0	5,0	10,0	26,5	5,0	13,0	32,5
6,0	7,0	17,0	6,0	10,5	28,0	6,0	14,0	35,5
			7,0	11,0	29,5	7,0	15,0	38,0
			8,0	11,5	30,0	8,0	15,5	40,0
			9,0	11,5	31,1	9,0	16,0	41,5
						10,0	16,5	42,0

LOA optic for open area illumination:

LOA - 1W/190lm min. 0,5lx			LOA - 3W/460lm min. 0,5lx			LOA - 6W/775lm min. 0.5lx		
H, m	L1, m	L2, m	H, m	L1, m	L2, m	H, m	L1, m	L2, m
2,5	2,5	13,5	2,5	6,0	17,0	2,5	6,5	20,0
3,0	2,5	14,0	3,0	7,0	18,0	3,0	6,5	22,5
3,5	2,5	14,5	3,5	7,5	19,5	3,5	7,0	24,0
4,0	2,0	14,5	4,0	7,5	21,0	4,0	7,5	26,5
4,5	2,0	15,0	4,5	7,0	22,5	4,5	7,5	27,5
5,0	2,0	15,0	5,0	5,5	24,0	5,0	7,0	28,5
6,0	1,5	14,5	6,0	3,0	25,0	6,0	5,5	30,5
7,0	1,0	14,0	7,0	3,0	25,5	7,0	4,5	31,0
			8,0	2,5	25,0	8,0	4,0	31,0
			9,0	2,5	24,0	9,0	4,0	31,0
			10,0	2,0	24,0	10,0	3,5	31,0

ARA S LED

Emergency Lighting

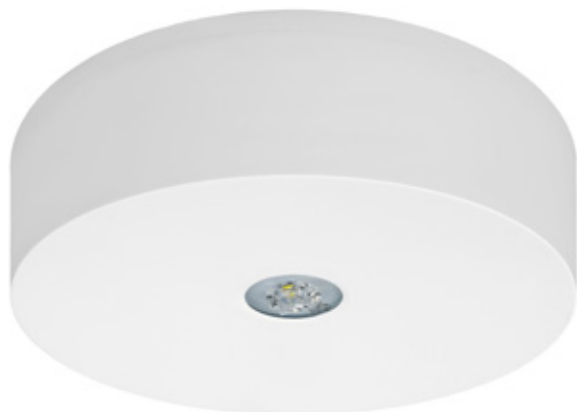

LOA



TRACK

DESCRIPTION: Surface mounted LED emergency escape luminaire

Light distribution type: direct

Optical system: lenses

Housing: polycarbonate

Colour: white; light grey; black

Battery charging time: 24 hours (12 hours optional: AUT)

Battery: NiCd (LiFePO4 optional: AUT), deep discharge protection

GENERAL DATA: **Mains voltage:** 220-240V, 50-60Hz
LED lifetime, h: 70000/L80B10
SDCM: 5
Protection class IEC: II
Ingress protection code: IP65
Mechanical impact resistance: IK08
Operating temperature range, °C: ta 0...+40 (CEBLED ta -25...+50)

INSTALLATION: On the ceiling or suspended (suspension bracket, wire to be ordered on request). Push-in terminal, 3x2x2.5mm²

ENVIRONMENT: Indoor

APPLICATION: Escape route lighting

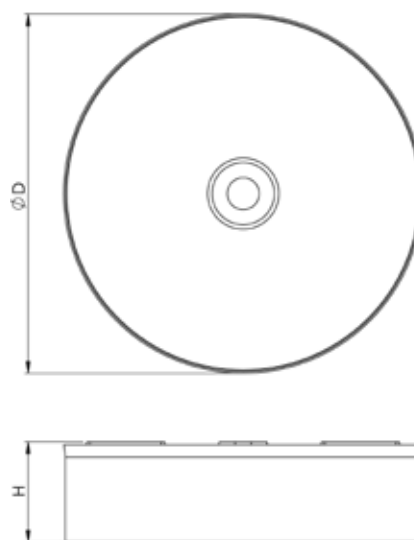

PRODUCT	DIAMETER, mm	HEIGHT, mm	ILLUMINATION MODE	EMERGENCY OPERATING TIME, H	LUMINAIRE OUTPUT*, lm	POWER IN EMERGENCY MODE, W*	CRI	CCT*, K	WEIGHT, kg
Ara S 1HLED C379 LER IP65	202	58	NM	1	180	1	80+	6000	1,4
Ara S 3HLED C380 LER IP65	202	58	NM	3	180	1	80+	6000	1,4
Ara S 1PLED C381 LER IP65	202	58	M/NM	1	180	1	80+	6000	1,4
Ara S 3PLED C382 LER IP65	202	58	M/NM	3	180	1	80+	6000	1,4
Ara S CEBLED C383 LER IP65	202	58	CEB	x	185	1	80+	6000	1,4
Ara S 1PLED C386 LER IP65	202	58	M/NM	1	390	3	80+	6000	1,4
Ara S 3PLED C387 LER IP65	202	58	M/NM	3	390	3	80+	6000	1,5
Ara S CEBLED C388 LER IP65	202	58	CEB	x	460	3	80+	6000	1,4
Ara S 1PLED C391 LOA IP65	202	58	M/NM	1	790	6	80+	6000	1,5
Ara S 3PLED C392 LOA IP65	202	58	M/NM	3	790	6	80+	6000	1,8
Ara S CEBLED C393 LOA IP65	202	58	CEB	x	790	6	80+	6000	1,5

*M - maintained (with an option of connecting as non-maintained), NM - non-maintained, CEB maintained, system power and output indicates data in emergency mode, tolerance range for optical and electrical data: ±10%, values apply to an ambient temperature of 25°C

AVAILABLE ACCESSORIES:



Product: Suspension MTG KIT SUSI

Description: Suspension wire set "I" type, 1.5m adjustable, 1pcs

*note - 1pcs MTG SUSI KIT for luminaire

*note - SUS option is required

OPTIONS AVAILABLE ON REQUEST:

	EMERGENCY		CONNECTION	OTHER	PROTECTION
DALI ¹	LOU	CEB	TRACK ⁴	SUS	tmin-25
LER	LOS	CLV			
LOA	TEST	EMS ³			
LEW	AUT ²				

1 DALI option is applicable for models: C381, C382, C386, C387, C391, C392

2 AUT option is applicable for models: C381, C382, C386, C387, C391, C392

3 EMS option is applicable for models: C381, C382, C386, C387, C391, C392

4 Only for non-maintained operation

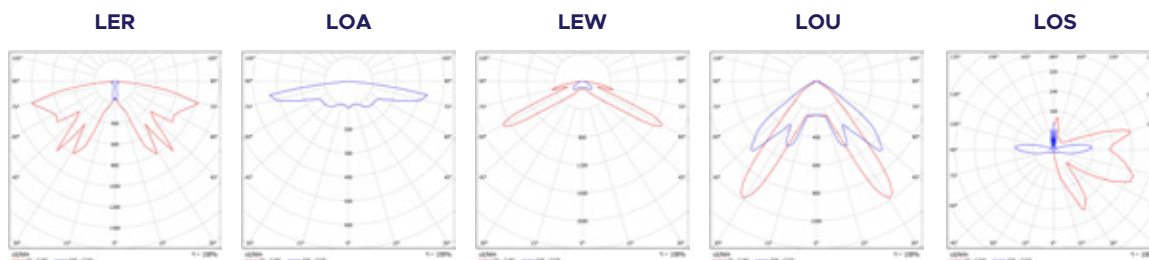

PHOTOMETRY OF LER / LOA

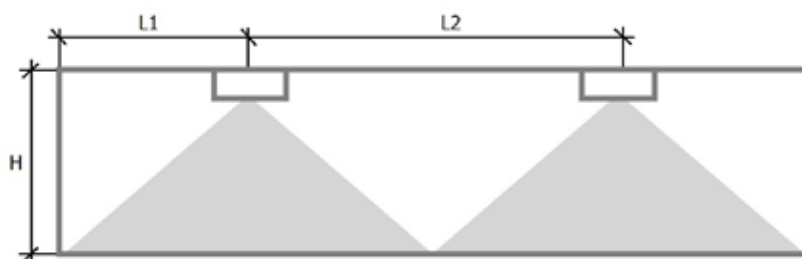

L1 - distance from the wall to the first fixture
L2 - distance between fixtures
H - height of the ceiling

LER optic for corridor route illumination:

LER - 1W/185lm min. 1lx			LER - 3W/460lm min. 1lx			LER - 6W/790lm min. 0.5lx		
H, m	L1, m	L2, m	H, m	L1, m	L2, m	H, m	L1, m	L2, m
2,5	6,0	15,0	2,5	8,0	20,0	2,5	10,0	24,5
3,0	6,5	16,0	3,0	8,5	21,5	3,0	11,0	27,0
3,5	6,5	17,0	3,5	9,0	23,0	3,5	11,5	28,5
4,0	7,0	18,0	4,0	9,5	24,5	4,0	12,0	31,5
4,5	7,5	18,5	4,5	10,0	25,5	4,5	12,5	32,5
5,0	7,0	18,0	5,0	10,0	26,5	5,0	13,0	32,5
6,0	7,0	17,0	6,0	10,5	28,0	6,0	14,0	35,5
			7,0	11,0	29,5	7,0	15,0	38,0
			8,0	11,5	30,0	8,0	15,5	40,0
			9,0	11,5	31,1	9,0	16,0	41,5
						10,0	16,5	42,0

LOA optic for open area illumination:

LOA - 1W/190lm min. 0.5lx			LOA - 3W/460lm min. 0.5lx			LOA - 6W/780lm min. 0.5lx		
H, m	L1, m	L2, m	H, m	L1, m	L2, m	H, m	L1, m	L2, m
2,5	2,5	13,5	2,5	6,0	17,0	2,5	6,5	20,0
3,0	2,5	14,0	3,0	7,0	18,0	3,0	6,5	22,5
3,5	2,5	14,5	3,5	7,5	19,5	3,5	7,0	24,0
4,0	2,0	14,5	4,0	7,5	21,0	4,0	7,5	26,5
4,5	2,0	15,0	4,5	7,0	22,5	4,5	7,5	27,5
5,0	2,0	15,0	5,0	5,5	24,0	5,0	7,0	28,5
6,0	1,5	14,5	6,0	3,0	25,0	6,0	5,5	30,5
7,0	1,0	14,0	7,0	3,0	25,5	7,0	4,5	31,0
			8,0	2,5	25,0	8,0	4,0	31,0
			9,0	2,5	24,0	9,0	4,0	31,0
			10,0	2,0	24,0	10,0	3,5	31,0

CORRIDOR R LED

Emergency Lighting

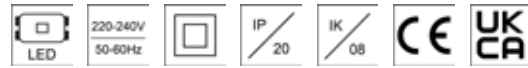

LOA



LER

DESCRIPTION: **Recessed mounted LED emergency escape luminaire**
Light distribution type: direct
Optical system: lenses
Housing: polycarbonate
Colour: white; light grey; black
Battery charging time: 24 hours (12 hours optional: AUT)
Battery: NiCd (LiFePO4 optional: AUT), deep discharge protection

GENERAL DATA: **Mains voltage:** 220-240V, 50-60Hz
LED lifetime, h: 70000/L80B10
SDCM: 5
Protection class IEC: II
Ingress protection code: IP20
Mechanical impact resistance: IK08
Operating temperature range, °C: ta 0...+40 (CEBLED ta -25...+50)

INSTALLATION: In ceilings with cut-out openings (mounting brackets included). Electronic gear and battery package installed in a separate box. Push-in terminal, 3x2x2.5mm²

ENVIRONMENT: Indoor

APPLICATION: Escape route lighting

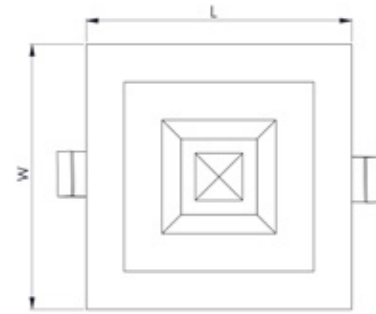

PRODUCT	LENGTH, mm	WIDTH, mm	HEIGHT, mm	CUT-OUT, mm	ILLUMINATION MODE	EMERGENCY OPERATING TIME, H	LUMINAIRE OUTPUT*, lm	POWER IN EMERGENCY MODE, W*	CRI	CCT*, K	WEIGHT, kg
Corridor R 1HLED U22 LER	95	95	48	83	NM	1	180	1	80+	6000	0,6
Corridor R 3HLED U24 LER	95	95	48	83	NM	3	180	1	80+	6000	0,7
Corridor R 1PLED U25 LER	95	95	48	83	M/NM	1	180	1	80+	6000	0,6
Corridor R 3PLED U27 LER	95	95	48	83	M/NM	3	180	1	80+	6000	0,7
Corridor R CEBLED C319 LER	95	95	48	83	CEB	x	190	1	80+	6000	0,6
Corridor R 1PLED J10 LER	95	95	48	83	NM	1	400	3	80+	6000	0,7
Corridor R 3PLED J12 LER	95	95	48	83	NM	3	400	3	80+	6000	0,7
Corridor R CEBLED C320 LER	95	95	48	83	CEB	x	460	3	80+	6000	0,7

*M - maintained (with an option of connecting as non-maintained), NM - non-maintained, CEB maintained, system power and output indicates data in emergency mode, tolerance range for optical and electrical data: ±10%, values apply to an ambient temperature of 25°C

OPTIONS AVAILABLE ON REQUEST:

EMERGENCY		
DALI ¹	LEW	CEB
LER	LOU	CLV
LOA	AUT	EMS

¹ DALI option is applicable for models: U25, U27, J10, J12

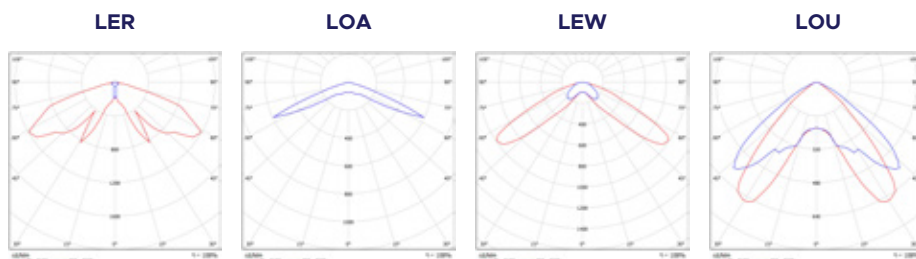

PHOTOMETRY OF LER / LOA

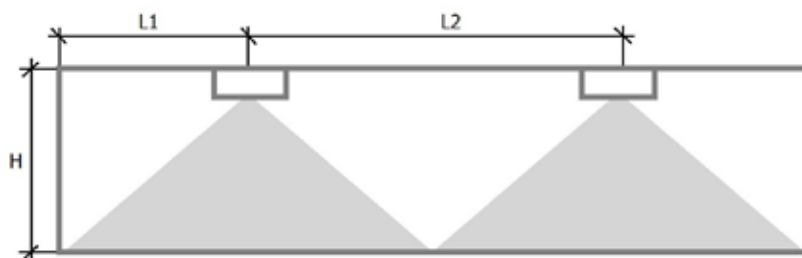

L1 - distance from the wall to the first fixture
L2 - distance between fixtures
H - height of the ceiling

LER optic for corridor route illumination:

LER - 1W/190lm min. 1lx			LER - 3W/460lm min. 1lx		
H, m	L1, m	L2, m	H, m	L1, m	L2, m
2,5	7,0	15,0	2,5	8,0	17,5
3,0	7,5	17,0	3,0	9,0	20,0
3,5	8,0	19,0	3,5	10,0	22,0
4,0	8,0	20,0	4,0	11,0	24,5
4,5	8,5	21,0	4,5	11,5	26,5
5,0	8,5	21,5	5,0	12,0	28,5
6,0	8,5	23,0	6,0	12,5	31,5
			7,0	13,5	33,0
			8,0	14,0	35,0
			9,0	14,0	36,0

LOA optic for open area illumination:

LOA - 1W/185lm min. 0,5lx			LOA - 3W/460lm min. 0,5lx		
H, m	L1, m	L2, m	H, m	L1, m	L2, m
2,5	3,5	11,5	2,50	5,5	12,0
3,0	3,5	12,5	3,00	6,0	14,0
3,5	5,5	13,5	3,50	7,0	16,0
4,0	6,0	15,0	4,00	7,0	17,5
4,5	3,0	16,0	4,50	8,0	19,0
5,0	2,0	16,5	5,00	8,5	20,5
6,0	1,0	17,5	6,00	9,5	23,0
			7,00	4,0	25,5
			8,00	0,5	22,0

CORRIDOR S LED

Emergency Lighting



DESCRIPTION: **A surface LED emergency escape luminaire**
Light distribution type: direct
Optical system: lenses
Housing: polycarbonate
Colour: white; light grey; black
Battery charging time: 24 hours (12 hours optional: AUT)
Battery: NiCd (LiFePO4 optional: AUT), deep discharge protection

GENERAL DATA: **Mains voltage:** 220-240V, 50-60Hz
LED lifetime, h: 70000/L80B10
SDCM: 5
Protection class IEC: II
Ingress protection code: IP41
Mechanical impact resistance: IK07
Operating temperature range, °C: ta 0...+40 (CEBLED ta -25...+50)

INSTALLATION: On the ceiling or wall. Screw terminal, 3x2x2.5mm²

ENVIRONMENT: Indoor

APPLICATION: Escape route lighting

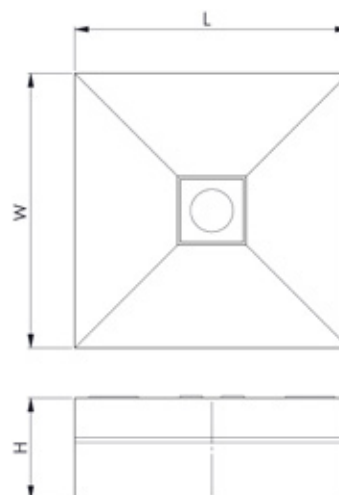

PRODUCT	LENGTH, mm	WIDTH, mm	HEIGHT, mm	ILLUMINATION MODE	EMERGENCY OPERATING TIME, H	LUMINAIRE OUTPUT*, lm	POWER IN EMERGENCY MODE, W*	CRI	CCT*, K	WEIGHT, kg
Corridor S 1HLED C321 LER	132	132	54	NM	1	180	1	80+	6000	0,5
Corridor S 3HLED C322 LER	132	132	54	NM	3	180	1	80+	6000	0,5
Corridor S 1PLED C323 LER	132	132	54	M/NM	1	180	1	80+	6000	0,5
Corridor S 3PLED C324 LER	132	132	54	M/NM	3	180	1	80+	6000	0,5
Corridor S CEBLED C325 LER	132	132	54	CEB	x	190	1	80+	6000	0,5
Corridor S 1PLED C328 LER	132	132	74	M/NM	1	390	3	80+	6000	0,7
Corridor S 3PLED C329 LER	132	132	74	M/NM	3	390	3	80+	6000	0,7
Corridor S CEBLED C330 LER	132	132	74	CEB	x	460	3	80+	6000	0,7

*M - maintained (with an option of connecting as non-maintained), NM - non-maintained, CEB maintained, system power and output indicates data in emergency mode, tolerance range for optical and electrical data: ±10%, values apply to an ambient temperature of 25°C

OPTIONS AVAILABLE ON REQUEST:

EMERGENCY		
DALI ¹	LOU	CEB
LER	TEST	CLV
LOA	AUT	EMS
LEW		

¹ DALI option is applicable for models: C323, C324, C328, C329

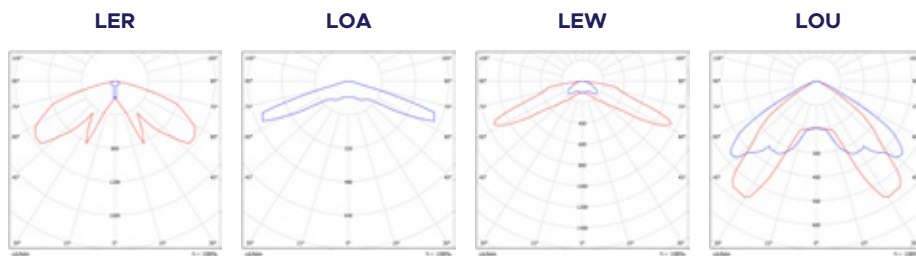

PHOTOMETRY OF LER / LOA

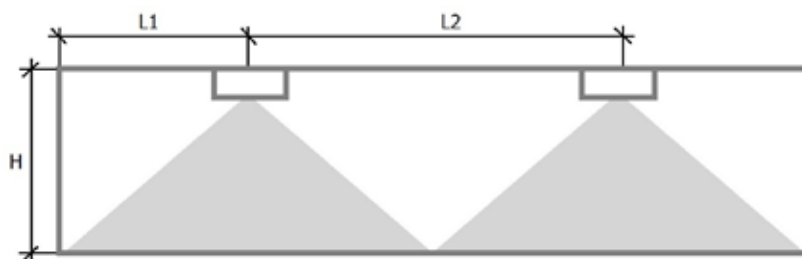

L1 - distance from the wall to the first fixture
L2 - distance between fixtures
H - height of the ceiling

LER optic for corridor route illumination:

LER - 1W/190lm min. 1lx			LER - 3W/460lm min. 1lx		
H, m	L1, m	L2, m	H, m	L1, m	L2, m
2,5	6,5	17,0	2,5	8,5	20,5
3,0	6,5	18,0	3,0	9,0	22,0
3,5	6,5	18,5	3,5	10,0	23,5
4,0	6,5	18,0	4,0	10,5	24,5
5,0	6,0	18,5	5,0	11,0	27,0
6,0	6,0	18,0	6,0	11,5	29,0
			7,0	11,5	30,5
			8,0	12,0	31,0
			9,0	11,0	32,0

LOA optic for open area illumination:

LOA - 1W/185lm min. 0,5lx			LOA - 3W/460lm min. 0,5lx		
H, m	L1, m	L2, m	H, m	L1, m	L2, m
2,5	4,5	13,0	2,5	5,0	18,0
3,0	2,5	14,0	3,0	5,5	19,5
3,5	2,0	14,5	3,5	5,5	20,5
4,0	1,5	14,0	4,0	5,5	21,0
5,0	1,0	13,5	5,0	4,0	22,0
			6,0	2,5	23,0
			7,0	2,5	22,5
			8,0	2,0	22,0

KNIK LED

Emergency Lighting



DESCRIPTION: **Surface mounted highbay LED emergency escape luminaire with selectable power**
Diffuser: linear prismatic transparent polycarbonate diffuser, water and impact resistant
Body: polycarbonate, white finish, with LED status indicator
Battery charging time: 24 hours
Battery: LiFePO4

GENERAL DATA: **Mains voltage:** 220-240V, 50-60Hz
LED lifetime, h: 50000/L70B50
SDCM: 5
Operating temperature range, °C: ta 0...+45
Protection class IEC: II
Ingress protection code: IP66
Mechanical impact resistance: IK08

INSTALLATION: On the ceiling or wall. Push-in terminal, 3x2x2.5mm²

ENVIRONMENT: Indoor

APPLICATION: Emergency lighting

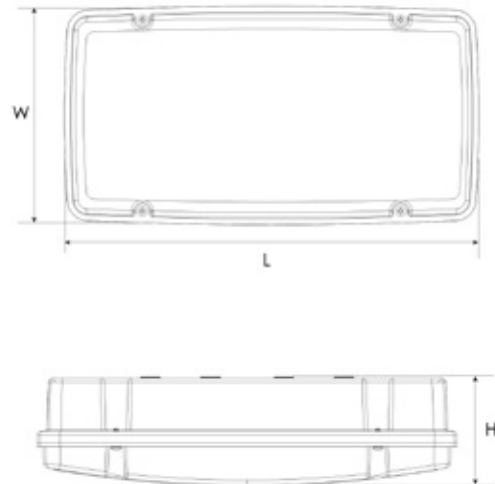

PRODUCT	LENGTH, mm	WIDTH, mm	HEIGHT, mm	ILLUMINATION MODE	EMERGENCY OPERATING TIME, H	LUMINAIRE OUTPUT*, lm	POWER IN EMERGENCY MODE, W*	CRI	CCT*, K	WEIGHT, kg
Knik 3HLED1x1000/1500 J607 T865	321	167	83	NM	3	1000 /1500	6,5 /10,0	80+	6500	1,5
Knik 3HLED1x1000/1500 J607 T865 AUT	321	167	83	NM	3	1000 /1500	6,5 /10,0	80+	6500	1,5

*M - maintained (with an option of connecting as non-maintained), NM - non-maintained, system power and output indicates data in emergency mode, tolerance range for optical and electrical data: ±10%, values apply to an ambient temperature of 25°C

STANDARD

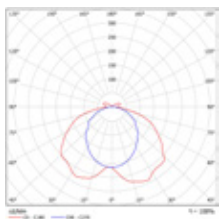

NORTHER LED

Emergency Lighting



DESCRIPTION: **Surface mounted LED emergency escape luminaire**
Light distribution type: direct
Optical system: tempered glass diffuser, impact resistant
Housing: stainless steel
Colour: white, RAL9003; light grey; black
Battery charging time: 24 hours (12 hours optional: AUT)
Battery: NiCd (LiFePO4 optional: AUT), deep discharge protection

GENERAL DATA: **Mains voltage:** 220-240V, 50-60Hz
LED lifetime, h: 70000/L80B10
SDCM: 5
Protection class IEC: I
Ingress protection code: IP66
Mechanical impact resistance: IK10
Operating temperature range, °C: ta 0...+40 (ta -25...+50 CEBLED)

INSTALLATION: On the wall. Push-in terminal, 4x2x2.5mm²

ENVIRONMENT: Outdoor

APPLICATION: Escape route lighting

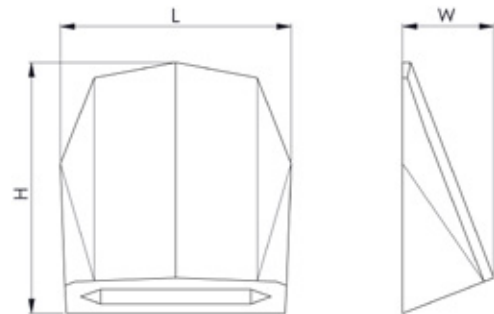

PRODUCT	LENGTH, mm	WIDTH, mm	HEIGHT, mm	ILLUMINATION MODE	EMERGENCY OPERATING TIME, H	LUMINAIRE OUTPUT*, lm	POWER IN EMERGENCY MODE, W*	CRI	CCT*, K	WEIGHT, kg
Norther 1PLED C334	222	77	227	M/NM	1	390	3	80+	6000	1,5
Norther 1PLED C335	222	77	227	M/NM	3	390	3	80+	6000	1,7
Norther CEBLED C336	222	77	227	CEB	x	460	3	80+	6000	1,5

*M - maintained (with an option of connecting as non-maintained), NM - non-maintained, CEB maintained, system power and output indicates data in emergency mode, tolerance range for optical and electrical data: ±10%, values apply to an ambient temperature of 25°C

OPTIONS AVAILABLE ON REQUEST:

EMERGENCY		PROTECTION
DALI ¹	CEB	tmin-25
TEST	CLV	
AUT	EMS	

¹ DALI option is not compatible with CEBLED option model: C336

STANDARD

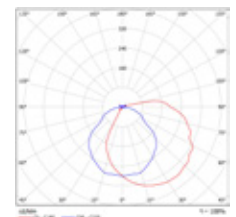

Photometry of Norther LED:

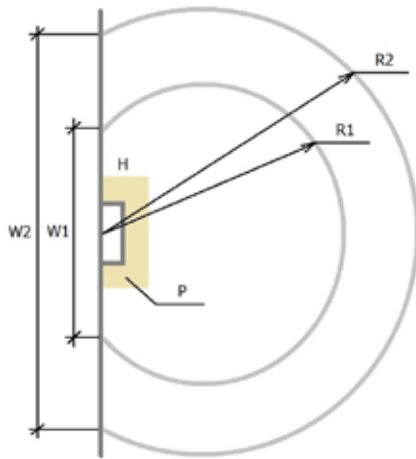

- R1** - radius of the average illumination >5lx
- W1** - distance from the wall with illumination >5lx
- R2** - radius of the average illumination >1lx
- W2** - distance from the wall with illumination >1lx
- P** - light intensity under the luminaire
- H** - mounting height of the luminaire

Norther LED 1lx and 5lx for the escape route

H, m	P, lx	W1 >5lx, m	R1 >5lx, m	W2 >1lx, m	R2 >1lx, m
2,0	39,0	7,5	6,0	4,5	3,5
2,2	32,0	8,0	6,0	4,5	3,5
2,4	26,0	8,0	6,5	5,0	3,5
2,6	22,0	8,0	7,0	5,0	3,5
2,8	19,0	8,5	6,5	5,0	3,5
3,0	17,0	8,5	6,5	5,0	3,5
3,2	15,0	9,0	9,0	5,0	3,5
3,4	13,0	9,0	7,0	5,0	3,5
3,6	11,0	10,0	7,0	4,5	3,5
3,8	10,0	9,5	7,0	4,5	3,5
4,0	9,0	10,0	7,5	4,5	3,0
5,0	5,8	11,0	7,5	2,0	2,5
6,0	4,0	11,0	7,5	0	0

SCORPIUS M LED



Emergency Lighting



Supplied with universal sticker kit

DESCRIPTION: Surface mounted double-sided LED emergency exit sign
Light distribution type: omnidirectional
Optical system: clear PMMA diffuser
Housing: polycarbonate
Colour: white
Battery charging time: 24 hours (12 hours optional: AUT)
Battery: NiCd (LiFePO4 optional: AUT), deep discharge protection
Recognition distance: 25 meters

GENERAL DATA: Mains voltage: 220-240V, 50-60Hz
 LED lifetime, h: 70000/L80B10
 Protection class IEC: II (CLV2LED III)
 Ingress protection code: IP65
 Mechanical impact resistance: IK08
 Operating temperature range, °C: ta 0...+40 (CEBLED ta 0...+50; CLV2LED ta -25...+50)

INSTALLATION: On the ceiling or wall (mounting brackets included), or suspended (requires an accessory). Push-in terminal, 4x2x2.5mm²

ENVIRONMENT: Indoor

APPLICATION: Emergency exit sign

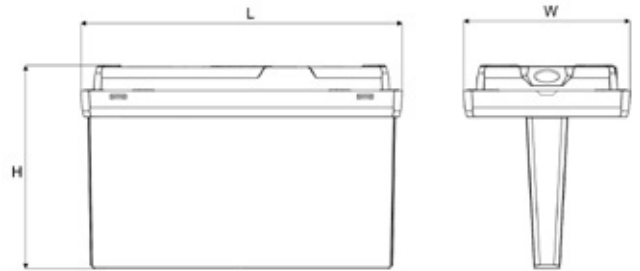

PRODUCT	LENGTH, mm	WIDTH, mm	HEIGHT, mm	ILLUMINATION MODE	EMERGENCY OPERATING TIME, H	POWER IN EMERGENCY MODE, W*	CRI	CCT*, K	WEIGHT, kg
Scorpius M 1HLED U71	276	143	174	NM	1	1	80+	6000	1,2
Scorpius M 3HLED U72	276	143	174	NM	3	1	80+	6000	1,3
Scorpius M 1PLED U73	276	143	174	M/NM	1	1	80+	6000	1,2
Scorpius M 3PLED U74	276	143	174	M/NM	3	1	80+	6000	1,2
Scorpius M CEBLED U75	276	143	174	CEB	x	1	80+	6000	1,1
Scorpius M CLV2LED U76	276	143	174	CLV2	x	1	80+	6000	1,1

*M - maintained (with an option of connecting as non-maintained), NM- non-maintained, CEB maintained, system power and output indicates data in emergency mode, tolerance range for optical and electrical data: ±10%, values apply to an ambient temperature of 25°C

OPTIONS AVAILABLE ON REQUEST:

EMERGENCY
DALI
AUT
CEB
CLV2
EMS

TAURUS LED

Emergency Lighting



Supplied with universal sticker kit

DESCRIPTION: **Surface mounted double-sided LED emergency exit sign**
Light distribution type: omnidirectional
Optical system: clear PMMA diffuser
Housing: extruded aluminium
Colour: light grey; black
Battery charging time: 24 hours (12 hours optional: AUT)
Battery: NiCd (LiFePO4 optional: AUT), deep discharge protection
Recognition distance: 30 meters

GENERAL DATA: **Mains voltage:** 220-240V, 50-60Hz
LED lifetime, h: 70000/L80B10
SDCM: 3
Protection class IEC: I
Ingress protection code: IP41
Mechanical impact resistance: IK02
Operating temperature range, °C: ta 0...+40 (CEBLED ta -25...+50)

INSTALLATION: On the ceiling or wall (mounting brackets included), or suspended (requires an accessory). Push-in terminal, 4x2x2.5mm²

ENVIRONMENT: Indoor

APPLICATION: Emergency exit sign

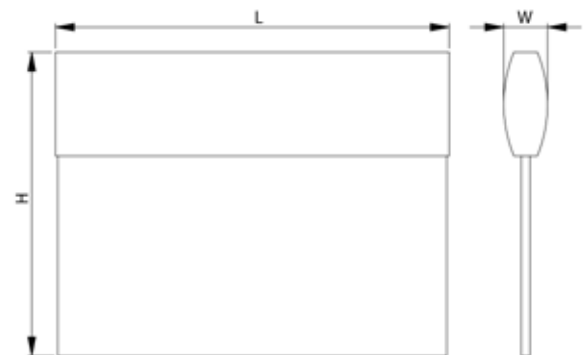

PRODUCT	LENGTH, mm	WIDTH, mm	HEIGHT, mm	ILLUMINATION MODE	EMERGENCY OPERATING TIME, H	POWER IN EMERGENCY MODE, W*	CRI	CCT*, K	WEIGHT, kg
Taurus 1HLED G05 Deluxe	315	48	243	NM	1	1	80+	6000	1,3
Taurus 3HLED G07 Deluxe	315	48	243	NM	3	1	80+	6000	1,3
Taurus 1PLED G08 Deluxe	315	48	243	M/NM	1	1	80+	6000	1,2
Taurus 3PLED G10 Deluxe	315	48	243	M/NM	3	1	80+	6000	1,3
Taurus CEBLED C339 Deluxe	315	48	243	CEB	x	1	80+	6000	1,3

*M - maintained (with an option of connecting as non-maintained), NM- non-maintained, CEB maintained, system power and output indicates data in emergency mode, tolerance range for optical and electrical data: ±10%, values apply to an ambient temperature of 25°C

OPTIONS AVAILABLE ON REQUEST:

EMERGENCY	
DALI ¹	CEB
TEST	CLV
AUT	EMS

¹ DALI option is applicable for models: G08, G10

AVAILABLE ACCESSORIES:



Product: Suspension MTG KIT Nashi/Taurus LED 1.5 (B/W)

Description: Suspension wire set, 1.5m adjustable (2pcs), black/ white

Product: Suspension MTG KIT Nashi/Taurus LED 3.0 (B/W)

Description: Suspension wire set, 3m adjustable (2pcs), black/ white

CAPELLA LED

Emergency Lighting



Supplied with universal sticker kit

DESCRIPTION: Recessed mounted LED emergency exit sign
Light distribution type: omnidirectional
Optical system: clear PMMA diffuser
Housing: steel
Colour: grey, RAL7045; white
Battery charging time: 24 hours (12 hours optional: AUT)
Battery: NiCd (LiFePO4 optional: AUT), deep discharge protection
Recognition distance: 30 meters

GENERAL DATA: Mains voltage: 220-240V, 50-60Hz
LED lifetime, h: 70000/L80B10
SDCM: 3
Protection class IEC: I
Ingress protection code: IP20
Mechanical impact resistance: IK02
Operating temperature range, °C: ta 0...+40 (CEBLED ta -25...+50)

INSTALLATION: In ceilings with cut-out openings (mounting brackets included). Push-in terminal, 4x2x2.5mm²

ENVIRONMENT: Indoor

APPLICATION: Emergency exit sign

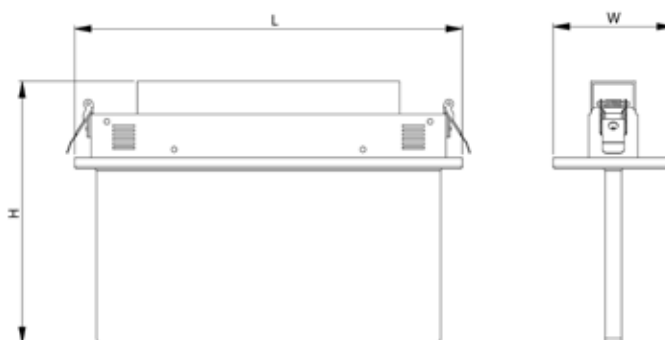

PRODUCT	LENGTH, mm	WIDTH, mm	HEIGHT, mm	CUT-OUT, mm	ILLUMINATION MODE	EMERGENCY OPERATING TIME, H	POWER IN EMERGENCY MODE, W*	CRI	CCT*, K	WEIGHT, kg
Capella 1HLED G17	355	110	210	330x65	NM	1	1	80+	6000	1,6
Capella 3HLED C24	355	110	210	330x65	NM	3	1	80+	6000	1,7
Capella 1PLED G19	355	110	210	330x65	M/NM	1	1	80+	6000	1,6
Capella 3PLED C25	355	110	210	330x65	M/NM	3	1	80+	6000	1,7
Capella CEBLED C340	355	110	210	330x65	CEB	x	1	80+	6000	1,6

*M - maintained (with an option of connecting as non-maintained), NM - non-maintained, CEB maintained, system power and output indicates data in emergency mode, tolerance range for optical and electrical data: ±10%, values apply to an ambient temperature of 25°C

OPTIONS AVAILABLE ON REQUEST:

EMERGENCY	
DALI ¹	CEB
TEST	CLV
AUT ²	

1 DALI option is applicable for models: G19, C25
 2 AUT option is applicable for models: G19, C25



HELM LED

Emergency Lighting



Supplied with universal sticker kit



DESCRIPTION: Surface mounted LED emergency exit sign / escape luminaire

Light distribution type: direct

Optical system: clear polycarbonate diffuser, impact resistant

Housing: polycarbonate

Colour: white; light grey; black

Battery charging time: 24 hours (12 hours optional: AUT)

Battery: NiCd (LiFePO4 optional: AUT), deep discharge protection

Recognition distance: Helm S: 20 meters; Helm: 25 meters; Helm B: 30 meters

GENERAL DATA: **Mains voltage:** 220-240V, 50-60Hz
LED lifetime, h: 70000/L80B10
SDCM: 3
Protection class IEC: II
Ingress protection code: IP65
Mechanical impact resistance: IK08
Operating temperature range, °C: ta 0...+40 (CEBLED ta -25...+50)

INSTALLATION: On the wall or ceiling, in ceilings with cut-out openings (mounting frame to be ordered separately). Push-in terminal, 3x2x2.5mm²

ENVIRONMENT: Indoor

APPLICATION: Emergency exit sign, escape route lighting



PRODUCT	LENGTH, mm	WIDTH, mm	HEIGHT, mm	ILLUMINATION MODE	EMERGENCY OPERATING TIME, H	POWER IN EMERGENCY MODE, W*	CRI	CCT*, K	WEIGHT, kg
Helm 1HLED C356	276	44	143	NM	1	1	80+	6000	0,5
Helm 3HLED C357	276	44	143	NM	3	1	80+	6000	0,6
Helm 1PLED C358	276	44	143	M/NM	1	1	80+	6000	0,5
Helm 3PLED C359	276	44	143	M/NM	3	1	80+	6000	0,6
Helm CEBLED C362	276	44	143	CEB	x	1	80+	6000	0,5
Helm 1PLED C360	276	44	143	M/NM	1	3	80+	6000	0,6
Helm 3PLED C361	276	44	143	M/NM	3	3	80+	6000	0,7
Helm CEBLED C363	276	44	143	CEB	x	3	80+	6000	0,6
Helm S 3HLED D539	226	42	125	NM	3	1	80+	6000	0,5
Helm S 3PLED D540	226	42	125	M/NM	3	1	80+	6000	0,6
Helm S CEBLED D999	226	42	125	CEB	x	1	80+	6000	0,5

PRODUCT	LENGTH, mm	WIDTH, mm	HEIGHT, mm	ILLUMINATION MODE	EMERGENCY OPERATING TIME, H	POWER IN EMERGENCY MODE, W*	CRI	CCT*, K	WEIGHT, kg
Helm B 1HLED U60	332	52	178	NM	1	1	80+	6000	0,5
Helm B 3HLED U61	332	52	178	NM	3	1	80+	6000	0,6
Helm B 1PLED U62	332	52	178	M/NM	1	1	80+	6000	0,5
Helm B 3PLED U63	332	52	178	M/NM	3	1	80+	6000	0,6
Helm B CEBLED U64	332	52	178	CEB	x	1	80+	6000	0,6
Helm B 1PLED U65	332	52	178	M/NM	1	3	80+	6000	0,5
Helm B 3PLED U66	332	52	178	M/NM	3	3	80+	6000	0,6
Helm B CEBLED U67	332	52	178	CEB	x	3	80+	6000	0,5

*M - maintained (with an option of connecting as non-maintained), NM - non-maintained, CEB maintained, system power and output indicates data in emergency mode, tolerance range for optical and electrical data: ±10%, values apply to an ambient temperature of 25°C

OPTIONS AVAILABLE ON REQUEST:

EMERGENCY		PROTECTION
DALI ¹	CLV	tmin-25
TEST	CLV2 ²	
AUT	EMS	
CEB		

1 DALI option is applicable for models: C358, C359, C360, C361, D539, D540, U62, U63, U65, U66
2 CLV2 option is applicable for Helm B LED models

AVAILABLE ACCESSORIES:



Product: Helm LED Exit blade
Description: PMMA exit blade with mounting springs



Product: Helm LED Recessed MTG kit
Description: Recessed mounting kit for Helm LED series



Product: Helm S LED Exit blade
Description: PMMA exit blade with mounting springs



Product: Helm S LED Recessed MTG kit
Description: Recessed mounting kit for Helm LED series



Product: Helm B LED Exit blade
Description: PMMA exit blade with mounting springs



Product: Helm B LED Recessed MTG kit
Description: Recessed mounting kit for Helm LED series



Product: WALL MTG bracket Helm B LED
Description: Bracket for Helm B LED luminaire installation on the wall, white, 1pc



Product: Pendant MTG kit Helm B LED
Description: Bracket for Helm B LED pendant installation, 1.0m, white, 1pc

STANDARD

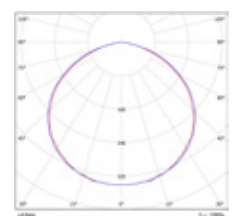

ZONDA LED

Emergency Lighting



Supplied with universal sticker kit

DESCRIPTION: **A surface double-sided LED emergency exit sign / escape luminaire**
Light distribution type: omnidirectional
Optical system: opal or clear (optional for escape route lighting) polycarbonate diffuser
Housing: polycarbonate
Colour: white
Battery charging time: 24 hours (12 hours optional: AUT)
Battery: NiCd (LiFePO4 optional: AUT), deep discharge protection
Recognition distance: 30 meters

GENERAL DATA: **Mains voltage:** 220-240V, 50-60Hz
LED lifetime, h: 70000/L80B10
SDCM: 3
Protection class IEC: II
Ingress protection code: IP44
Mechanical impact resistance: IK08
Operating temperature range, °C: ta 0...+40 (CEBLED ta 0...+50)

INSTALLATION: On the ceiling or wall. Screw terminal, 3x2x2.5mm²

ENVIRONMENT: Indoor

APPLICATION: Emergency exit sign, escape route lighting



PRODUCT	LENGTH, mm	WIDTH, mm	HEIGHT, mm	ILLUMINATION MODE	EMERGENCY OPERATING TIME, H	POWER IN EMERGENCY MODE, W*	CRI	CCT*, K	WEIGHT, kg
Zonda 1HLED C348 OP	325	41	250	NM	1	1	80+	6000	0,5
Zonda 3HLED C349 OP	325	41	250	NM	3	1	80+	6000	0,6
Zonda 1PLED C350 OP	325	41	250	M/NM	1	1	80+	6000	0,5
Zonda 3PLED C351 OP	325	41	250	M/NM	3	1	80+	6000	0,6
Zonda CEBLED C352 OP	325	41	250	CEB	x	1	80+	6000	0,6
Zonda 1PLED C353 2CLR	325	41	250	M/NM	1	3	80+	6000	0,5
Zonda 3PLED C354 2CLR	325	41	250	M/NM	3	3	80+	6000	0,6
Zonda CEBLED C355 2CLR	325	41	250	CEB	x	3	80+	6000	0,5

*M - maintained (with an option of connecting as non-maintained), NM - non-maintained, CEB maintained, system power and output indicates data in emergency mode, tolerance range for optical and electrical data: ±10%, values apply to an ambient temperature of 25°C

OPTIONS AVAILABLE ON REQUEST:

REFLECTOR AND OPTICS	EMERGENCY	
2CLR	DALI ¹	CEB
	TEST	CLV
	AUT	EMS

¹ DALI option is not compatible with CEBLED option model: C355, C348 and models: C348, C349

AVAILABLE ACCESSORIES:



Product: Zonda LED Wall MTG kit
Description: Wall mounting kit for Zonda LED series

STANDARD

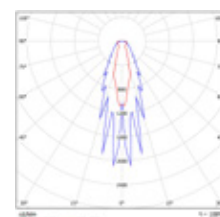



NASHI S LED

Emergency Lighting



TRACK



Supplied with universal sticker kit

DESCRIPTION: **Surface mounted double-sided LED emergency exit sign**
Light distribution type: omnidirectional
Optical system: clear PMMA diffuser
Housing: polycarbonate
Colour: white; light grey; black
Battery charging time: 24 hours (12 hours optional: AUT)
Battery: NiCd (LiFePO4 optional: AUT), deep discharge protection
Recognition distance: 25 meters

GENERAL DATA: **Mains voltage:** 220-240V, 50-60Hz
LED lifetime, h: 70000/L80B10
SDCM: 3
Protection class IEC: II
Ingress protection code: IP44
Mechanical impact resistance: IK02
Operating temperature range, °C: ta 0...+40 (CEBLED ta -25...+50)

INSTALLATION: On the ceiling, wall or suspended (suspension kit to be ordered separately). Screw terminal, 3x2x2.5mm²

ENVIRONMENT: Indoor

APPLICATION: Emergency exit sign

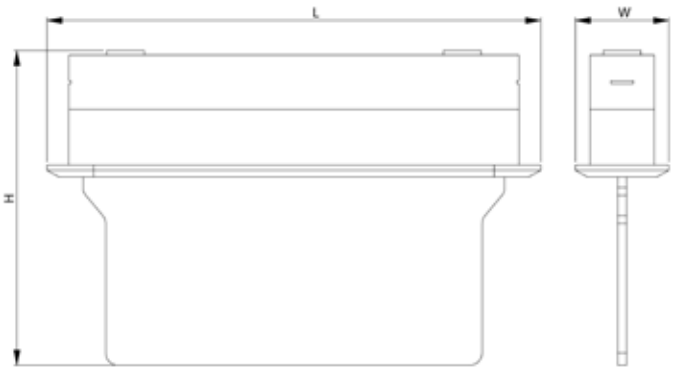

PRODUCT	LENGTH, mm	WIDTH, mm	HEIGHT, mm	ILLUMINATION MODE	EMERGENCY OPERATING TIME, H	POWER IN EMERGENCY MODE, W*	CRI	CCT*, K	WEIGHT, kg
Nashi S 3PLED C434 TEST	299	43	206	M/NM	3	1	80+	6000	1,2
Nashi S 3PLED C434 AUT	299	43	206	M/NM	3	1	80+	6000	1,2
Nashi S CEBLED C435	299	43	206	CEB	x	1	80+	6000	1,0

*M - maintained (with an option of connecting as non-maintained), NM - non-maintained, CEB maintained, system power and output indicates data in emergency mode, tolerance range for optical and electrical data: ±10%, values apply to an ambient temperature of 25°C

OPTIONS AVAILABLE ON REQUEST:

EMERGENCY	CONNECTION
TEST	TRACK ¹
AUT	
CEB	
CLV	
EMS	

¹ Only for non-maintained operation

AVAILABLE ACCESSORIES:

Product: Suspension MTG KIT Nashi/Taurus LED (B/W)
Description: Suspension wire set, 1.5m adjustable (2pcs), black/ white

Product: Suspension MTG KIT Nashi/Taurus LED (B/W)
Description: Suspension wire set, 3m adjustable (2pcs), black/ white





NASHI R LED

Emergency Lighting



DESCRIPTION: **Recessed mounted double-sided LED emergency exit sign**
Light distribution type: omnidirectional
Optical system: clear PMMA diffuser
Housing: polycarbonate
Colour: white; light grey; black
Battery charging time: 24 hours (12 hours optional: AUT)
Battery: NiCd (LiFePO4 optional: AUT), deep discharge protection
Recognition distance: 25 meters

GENERAL DATA: **Mains voltage:** 220-240V, 50-60Hz
LED lifetime, h: 70000/L80B10
SDCM: 3
Protection class IEC: II
Ingress protection code: IP44
Mechanical impact resistance: IK02
Operating temperature range, °C: ta 0...+40 (CEBLED ta -25...+50)

INSTALLATION: In ceilings with cut-out openings (mounting brackets included). Screw terminal, 3x2x2.5mm²

ENVIRONMENT: Indoor

APPLICATION: Emergency exit sign



Supplied with universal sticker kit

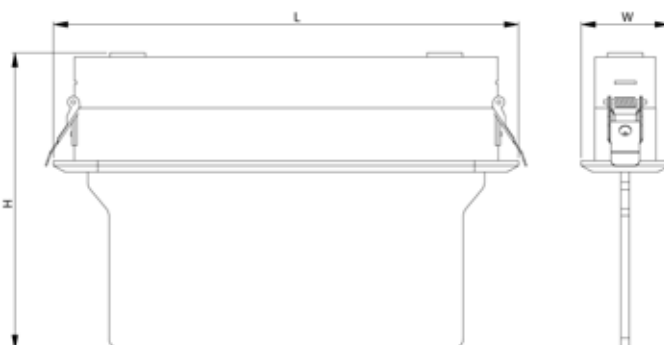

PRODUCT	LENGTH, mm	WIDTH, mm	HEIGHT, mm	CUT-OUT, mm	ILLUMINATION MODE	EMERGENCY OPERATING TIME, H	POWER IN EMERGENCY MODE, W*	CRI	CCT*, K	WEIGHT, kg
Nashi R 1HLED C436	328	62	206	300x45	NM	1	1	80+	6000	1,0
Nashi R 3HLED C437	328	62	206	300x45	NM	3	1	80+	6000	1,2
Nashi R 1PLED C438	328	62	206	300x45	M/NM	1	1	80+	6000	1,2
Nashi R 3PLED C439	328	62	206	300x45	M/NM	3	1	80+	6000	1,2
Nashi R 3PLED C439 TEST	328	62	206	300x45	M/NM	3	1	80+	6000	1,2
Nashi R 3PLED C439 AUT	328	62	206	300x45	M/NM	3	1	80+	6000	1,2
Nashi R CEBLED C440	328	62	206	300x45	CEB	x	1	80+	6000	1,0

*M - maintained (with an option of connecting as non-maintained), NM - non-maintained, CEB maintained, system power and output indicates data in emergency mode, tolerance range for optical and electrical data: ±10%, values apply to an ambient temperature of 25°C

OPTIONS AVAILABLE ON REQUEST:

EMERGENCY	
DALI ¹	CEB
TEST	CLV
AUT	EMS

¹ DALI option is applicable for models: C438, C439



LEPUS S LED

Emergency Lighting



DESCRIPTION: **Wall-mounted LED emergency exit sign**
Light distribution type: direct
Optical system: clear PMMA diffuser
Housing: polycarbonate
Colour: white; light grey; black
Battery charging time: 24 hours (12 hours optional: AUT)
Battery: NiCd (LiFePO4 optional: AUT), deep discharge protection
Recognition distance: 30 meters

GENERAL DATA: **Mains voltage:** 220-240V, 50-60Hz
LED lifetime, h: 70000/L80B10
SDCM: 3
Protection class IEC: II
Ingress protection code: IP40
Mechanical impact resistance: IK05
Operating temperature range, °C: ta 0...+40 (CEBLED ta -25...+50)

INSTALLATION: On the wall. Push-in terminal, 3x2x2.5mm²

ENVIRONMENT: Indoor

APPLICATION: Emergency exit sign



Supplied with universal sticker kit



PRODUCT	LENGTH, mm	WIDTH, mm	HEIGHT, mm	ILLUMINATION MODE	EMERGENCY OPERATING TIME, H	POWER IN EMERGENCY MODE, W*	CRI	CCT*, K	WEIGHT, kg
Lepus S 1PLED G061	337	57	189	M/NM	1	1	80+	6000	1,2
Lepus S 3PLED G062	337	57	189	M/NM	3	1	80+	6000	1,2
Lepus S CEBLED G063	337	57	189	CEB	x	1	80+	6000	1,1
Lepus S 1PLED E996 2CLR AUT	337	57	189	M/NM	1	3	80+	6000	1,2
Lepus S 3PLED E997 2CLR AUT	337	57	189	M/NM	3	3	80+	6000	1,2
Lepus S CEBLED E998 2CLR	337	57	189	CEB	x	3	80+	6000	1,1

*M - maintained (with an option of connecting as non-maintained), NM - non-maintained, CEB maintained, system power and output indicates data in emergency mode, tolerance range for optical and electrical data: ±10%, values apply to an ambient temperature of 25°C

OPTIONS AVAILABLE ON REQUEST:

EMERGENCY	
DALI ¹	CEB
TEST	CLV
AUT	EMS

¹ DALI option is applicable for models: G061, G062

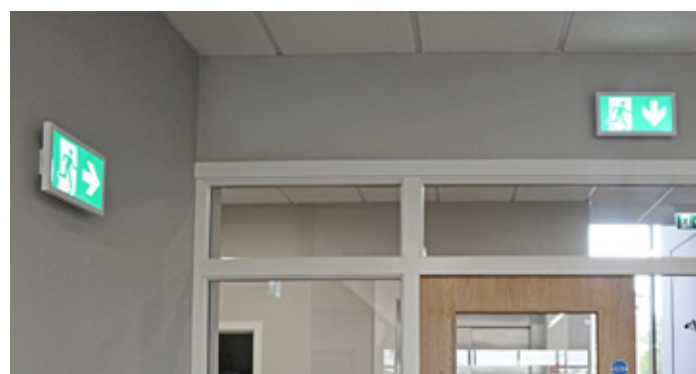

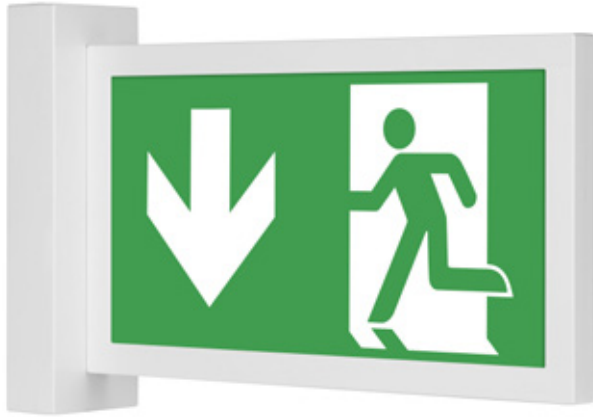

LEPUS W LED

Emergency Lighting



DESCRIPTION:

Wall-mounted double-sided LED emergency exit sign
Light distribution type: omnidirectional
Optical system: clear PMMA diffuser
Housing: polycarbonate
Colour: white; light grey; black
Battery charging time: 24 hours (12 hours optional: AUT)
Battery: NiCd (LiFePO4 optional: AUT), deep discharge protection
Recognition distance: 30 meters

GENERAL DATA:

Mains voltage: 220-240V, 50-60Hz
LED lifetime, h: 70000/L80B10
SDCM: 3
Protection class IEC: II
Ingress protection code: IP40
Mechanical impact resistance: IK05
Operating temperature range, °C: ta 0...+40 (CEBLED ta -25...+50)

INSTALLATION:

On the wall. Push-in terminal, 3x2x2.5mm²

ENVIRONMENT:

Indoor

APPLICATION:

Emergency exit sign



Supplied with universal sticker kit



PRODUCT	LENGTH, mm	WIDTH, mm	HEIGHT, mm	ILLUMINATION MODE	EMERGENCY OPERATING TIME, H	POWER IN EMERGENCY MODE, W*	CRI	CCT*, K	WEIGHT, kg
Lepus W 1PLED G066	375	72	232	M/NM	1	1	80+	6000	1,4
Lepus W 3PLED G067	375	72	232	M/NM	3	1	80+	6000	1,4
Lepus W CEBLED G068	375	72	232	CEB	x	1	80+	6000	1,4
Lepus W 1PLED G079 2CLR AUT	375	72	232	M/NM	1	3	80+	6000	1,4
Lepus W 3PLED G080 2CLR AUT	375	72	232	M/NM	3	3	80+	6000	1,4
Lepus W CEBLED G081 2CLR	375	72	232	CEB	x	3	80+	6000	1,4

*M - maintained (with an option of connecting as non-maintained), NM - non-maintained, CEB maintained, system power and output indicates data in emergency mode, tolerance range for optical and electrical data: ±10%, values apply to an ambient temperature of 25°C

OPTIONS AVAILABLE ON REQUEST:

EMERGENCY	
DALI ¹	CEB
TEST	CLV
AUT	EMS

¹ DALI option is applicable for models: G066, G067

LEPORIS C LED

Emergency Lighting



DESCRIPTION: **Surface mounted double-sided LED emergency exit sign**
Light distribution type: omnidirectional
Optical system: clear PMMA diffuser
Housing: polycarbonate
Colour: white; light grey; black
Battery charging time: 24 hours (12 hours optional: AUT)
Battery: NiCd (LiFePO4 optional: AUT), deep discharge protection
Recognition distance: 30 meters

GENERAL DATA: **Mains voltage:** 220-240V, 50-60Hz
LED lifetime, h: 70000/L80B10
SDCM: 3
Protection class IEC: II
Ingress protection code: IP40
Mechanical impact resistance: IK05
Operating temperature range, °C: ta 0...+40

INSTALLATION: On the ceiling. Push-in terminal, 3x2x2.5mm²

ENVIRONMENT: Indoor

APPLICATION: Emergency exit sign



Supplied with universal sticker kit



PRODUCT	LENGTH, mm	WIDTH, mm	HEIGHT, mm	ILLUMINATION MODE	EMERGENCY OPERATING TIME, H	POWER IN EMERGENCY MODE, W*	CRI	CCT*, K	WEIGHT, kg
Leporis C 1PLED G071	337	72	224	M/NM	1	1	80+	6000	1,4
Leporis C 3PLED G072	337	72	224	M/NM	3	1	80+	6000	1,4
Leporis C CEBLED G073	337	72	224	CEB	x	1	80+	6000	1,4
Leporis C 1PLED G082 2CLR AUT	337	72	224	M/NM	1	3	80+	6000	1,4
Leporis C 3PLED G083 2CLR AUT	337	72	224	M/NM	3	3	80+	6000	1,4
Leporis C CEBLED G084 2CLR	337	72	224	CEB	x	3	80+	6000	1,4

*M - maintained (with an option of connecting as non-maintained), NM - non-maintained, CEB maintained, system power and output indicates data in emergency mode, tolerance range for optical and electrical data: ±10%, values apply to an ambient temperature of 25°C

OPTIONS AVAILABLE ON REQUEST:

EMERGENCY	
DALI ¹	CEB
TEST	CLV
AUT	EMS

¹ DALI option is applicable for models: G071, G072



LEPORIS U LED

Emergency Lighting

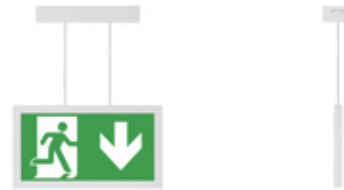

DESCRIPTION: **Suspended double-sided LED emergency exit sign**
Light distribution type: omnidirectional
Optical system: clear PMMA diffuser
Housing: polycarbonate
Colour: white; light grey; black
Battery charging time: 24 hours (12 hours optional: AUT)
Battery: NiCd (LiFePO4 optional: AUT), deep discharge protection
Recognition distance: 30 meters

GENERAL DATA: **Mains voltage:** 220-240V, 50-60Hz
LED lifetime, h: 70000/L80B10
SDCM: 3
Protection class IEC: II
Ingress protection code: IP40
Mechanical impact resistance: IK02
Operating temperature range, °C: ta 0...+40

INSTALLATION: On to the ceiling. Push-in terminal, 2x2x2.5mm²

ENVIRONMENT: Indoor

APPLICATION: Emergency exit sign



Supplied with universal sticker kit

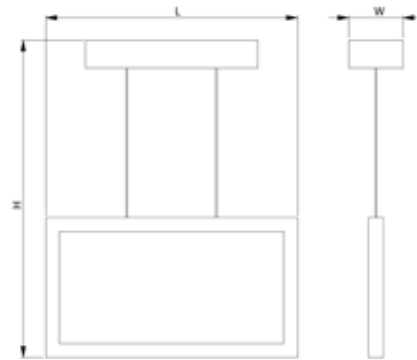

PRODUCT	LENGTH, mm	WIDTH, mm	HEIGHT, mm	ILLUMINATION MODE	EMERGENCY OPERATING TIME, H	POWER IN EMERGENCY MODE, W*	CRI	CCT*, K	WEIGHT, kg
Leporis U 1PLED G076	224	72	337	M/NM	1	1	80+	6000	1,4
Leporis U 3PLED G077	224	72	337	M/NM	3	1	80+	6000	1,4
Leporis U CEBLED G078	224	72	337	CEB	x	1	80+	6000	1,5
Leporis U 1PLED G085 2CLR AUT	224	72	337	M/NM	1	3	80+	6000	1,4
Leporis U 3PLED G086 2CLR AUT	224	72	337	M/NM	3	3	80+	6000	1,4
Leporis U CEBLED G087 2CLR	224	72	337	CEB	x	3	80+	6000	1,5

*M - maintained (with an option of connecting as non-maintained), NM- non-maintained, CEB maintained, system power and output indicates data in emergency mode, tolerance range for optical and electrical data: ±10%, values apply to an ambient temperature of 25°C

OPTIONS AVAILABLE ON REQUEST:

EMERGENCY	
DALI ¹	CEB
TEST	CLV
AUT	EMS

¹ DALI option is applicable for models: G076, G077

SEASON LED

Emergency Lighting



DESCRIPTION: Surface mounted four-sided LED emergency exit sign
Light distribution type: direct
Optical system: opal polycarbonate diffuser
Housing: steel / aluminium
Colour: white, RAL9003
Battery charging time: 12 hours
Battery: LiFePO4, deep discharge protection
Recognition distance: 35 meters

GENERAL DATA: **Mains voltage:** 220-240V, 50-60Hz
LED lifetime, h: 70000/L80B10
Protection class IEC: I
Ingress protection code: IP54
Mechanical impact resistance: IK08
Operating temperature range, °C: ta 0...+40 (CEBLED ta -25...+50)

INSTALLATION: On the ceiling. Push-in terminal, 4x2x2.5mm² (CEBLED 3x2x2.5mm²)

ENVIRONMENT: Indoor

APPLICATION: Emergency exit sign

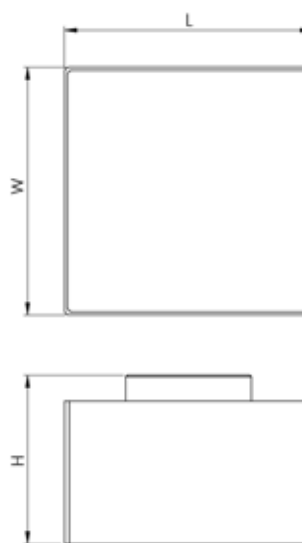

PRODUCT	LENGTH, mm	WIDTH, mm	HEIGHT, mm	ILLUMINATION MODE	EMERGENCY OPERATING TIME, H	POWER IN EMERGENCY MODE, W*	CCT*, K	WEIGHT, kg
Season 1PLED U56 OP (FS.../BS.../RS.../LS...)	335	335	228	M/NM	1	4	6000	2,9
Season 3PLED U57 OP (FS.../BS.../RS.../LS...)	335	335	228	M/NM	3	4	6000	3,1
Season CEBLED U58 OP (FS.../BS.../RS.../LS...)	335	335	228	CEB	x	4	6000	2,5

*M - maintained (with an option of connecting as non-maintained), NM - non-maintained, CEB maintained, system power and output indicates data in emergency mode, tolerance range for optical and electrical data: ±10%, values apply to an ambient temperature of 25°C

OPTIONS AVAILABLE ON REQUEST:

EMERGENCY		OTHER	
DALI ¹	CEB	Pictogram 24 - turn left	Pictogram 00 - blank
TEST	CLV2	Pictogram 25 - turn right	Pictogram size 150x300mm
AUT	EMS	Pictogram 26 - down (arrow in the left)	FS - pictogram from the front side (FS24, FS25, FS26, FS27, FS29, FS30, FS00)
		Pictogram 27 - down (arrow in the right)	BS - pictogram from the back side (BS24, BS25, BS26, BS27, BS29, BS30, BS00)
		Pictogram 29 - up (arrow in the left)	RS - pictogram from the right side (RS24, RS25, RS26, RS27, RS29, RS30, RS00)
		Pictogram 30 - up (arrow in the right)	LS - pictogram from the left side (LS24, LS25, LS26, LS27, LS29, LS30, LS00)

¹ DALI option is applicable for model: U56

AVAILABLE ACCESSORIES:



Product: WALL MTG bracket Season LED
Description: Bracket for Season LED luminaire installation on the wall, white, 1pc



Product: Pendant MTG kit Season LED
Description: Bracket for Season LED pendant installation, 1.0m, white, 1pc



Product: Suspension MTG kit Season LED
Description: Four wire set for suspended Season LED installation, 3.0m adjustable, 1pc
**1pcs MTG KIT SUSI for one fitting required*

LIBRA LED

Emergency Lighting



Supplied with universal sticker kit



DESCRIPTION: Surface mounted LED emergency exit sign / escape luminaire

Light distribution type: direct
Optical system: opal or clear polycarbonate diffuser, impact resistant
Housing: polycarbonate
Colour: white
Battery charging time: 24 hours
Battery: NiCd / LiFePO4
Recognition distance: 20 meters

GENERAL DATA: **Mains voltage:** 220-240V, 50-60Hz
LED lifetime, h: 50000/L70B50
SDCM: 5
Protection class IEC: I
Ingress protection code: IP65
Mechanical impact resistance: IK08
Operating temperature range, °C: ta 0...+40

INSTALLATION: On the wall. Push-in terminal, 4x2x2.5mm²

ENVIRONMENT: Indoor

APPLICATION: Emergency exit sign, escape route lighting (clear version)



PRODUCT	LENGTH, mm	WIDTH, mm	HEIGHT, mm	ILLUMINATION MODE	EMERGENCY OPERATING TIME, H	POWER IN EMERGENCY MODE, W*	CRI	CCT*, K	WEIGHT, kg
Libra 3PLED G117 OP TEST	350	110	60	M/NM	3	1	70+	6000	1,4
Libra 3PLED G117 CLR TEST	350	110	60	M/NM	3	1	70+	6000	1,4
Libra 3PLED G117 OP AUT	350	110	60	M/NM	3	1	70+	6000	1,4
Libra 3PLED G117 CLR AUT	350	110	60	M/NM	3	1	70+	6000	1,4

*M - maintained (with an option of connecting as non-maintained), NM - non-maintained, system power and output indicates data in emergency mode, tolerance range for optical and electrical data: ±10%, values apply to an ambient temperature of 25°C

AVAILABLE ACCESSORIES:



Product: Libra PRG SPORT
Description: White protection grid for LIBRA



Product: Pictogram "Fire hose reel" Libra/Hydra LED
Description: Pictogram "Fire hose reel" for Libra/Hydra LED

OPTIONS AVAILABLE ON REQUEST:

REFLECTOR AND OPTICS	EMERGENCY
OP	TEST
CLR	AUT

GEMINI LED



Emergency Lighting



Supplied with universal sticker kit



DESCRIPTION: **Surface mounted LED emergency exit sign / escape luminaire**
Light distribution type: direct
Optical system: clear polycarbonate diffuser, impact resistant
Housing: polycarbonate, with test button
Colour: white
Battery charging time: 24 hours
Battery: NiCd
Recognition distance: 16 meters

GENERAL DATA: **Mains voltage:** 220-240V, 50-60Hz
LED lifetime, h: 50000/L70B50
SDCM: 5
Protection class IEC: I
Ingress protection code: IP65
Mechanical impact resistance: IK08
Operating temperature range, °C: ta 0...+40

INSTALLATION: On the wall. Push-in terminal, 4x2x2.5mm²

ENVIRONMENT: Indoor

APPLICATION: Emergency exit sign, escape route lighting



PRODUCT	LENGTH, mm	WIDTH, mm	HEIGHT, mm	ILLUMINATION MODE	EMERGENCY OPERATING TIME, H	POWER IN EMERGENCY MODE, W*	CRI	CCT*, K	WEIGHT, kg
Gemini 3PLED D549 CLR TEST	276	110	60	M/NM	3	1	70+	6000	0,5

*M - maintained (with an option of connecting as non-maintained), NM - non-maintained, system power and output indicates data in emergency mode, tolerance range for optical and electrical data: ±10%, values apply to an ambient temperature of 25°C

AVAILABLE ACCESSORIES:



Product: Pictogram "Fire hose reel" Gemini LED
Description: Pictogram "Fire hose reel" for Gemini LED



HYDRA LED

Emergency Lighting



Supplied with universal sticker kit



DESCRIPTION: **Surface mounted double-sided LED emergency exit sign**
Light distribution type: direct
Optical system: opal polycarbonate diffuser, impact resistant
Housing: polycarbonate, with test button
Colour: white
Battery charging time: 24 hours
Battery: LiFePO4
Recognition distance: 20 meters

GENERAL DATA: **Mains voltage:** 220-240V, 50-60Hz
LED lifetime, h: 50000/L70B50
SDCM: 5
Protection class IEC: I
Ingress protection code: IP65
Mechanical impact resistance: IK08
Operating temperature range, °C: ta 0...+40

INSTALLATION: On the ceiling. Push-in terminal, 4x2x2.5mm²

ENVIRONMENT: Indoor

APPLICATION: Emergency exit sign

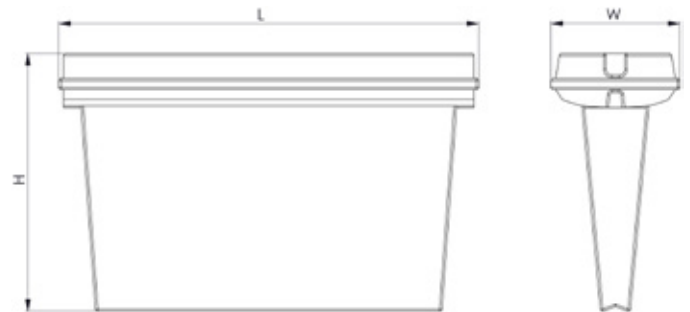

PRODUCT	LENGTH, mm	WIDTH, mm	HEIGHT, mm	ILLUMINATION MODE	EMERGENCY OPERATING TIME, H	POWER IN EMERGENCY MODE, W*	CRI	CCT*, K	WEIGHT, kg
Hydra 3PLED G119 TEST	350	110	220	M/NM	3	1	70+	6000	1,7
Hydra 3PLED G119 AUT	350	110	220	M/NM	3	1	70+	6000	1,7

*M - maintained (with an option of connecting as non-maintained), NM - non-maintained, system power and output indicates data in emergency mode, tolerance range for optical and electrical data: ±10%, values apply to an ambient temperature of 25°C

AVAILABLE ACCESSORIES:



Product: Pictogram "Fire hose reel"
 Libra/Hydra LED
Description: Pictogram "Fire hose reel" for Libra/Hydra LED

OPTIONS AVAILABLE ON REQUEST:

EMERGENCY
TEST
AUT

SPOTLIGHTS



PEGASUS H LED

Spotlights



Horizontal rotation 355° and tilting ±30°

- DESCRIPTION:** Recessed mounted adjustable LED spotlight
Light distribution type: direct
Optical system: faceted aluminium reflector, clear PMMA diffuser
Housing: aluminium
Colour: white, RAL9016
-
- GENERAL DATA:** Mains voltage: 220-240V, 0/50-60Hz
 LED lifetime, h: 60000/L80B10
 SDCM: 3
 Protection class IEC: II
 Ingress protection code: IP20
 Mechanical impact resistance: IK02
 Operating temperature range, °C: ta 0...+35
-
- INSTALLATION:** In ceilings with cut-out openings (mounting brackets included). Push-in terminal, 2x1.5mm²
-
- ENVIRONMENT:** Indoor
-
- APPLICATION:** Retail, showroom, museum, exhibition, public place

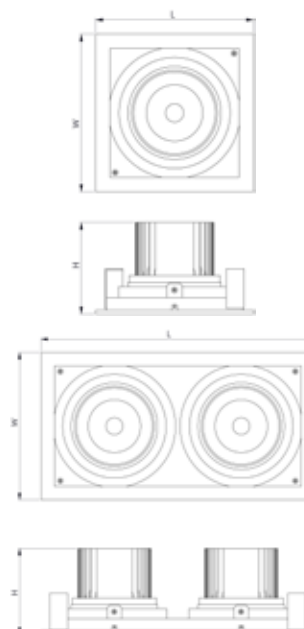

PRODUCT	LENGTH, mm	WIDTH, mm	HEIGHT, mm	CUT-OUT, mm	LUMINAIRE OUTPUT*, lm	SYSTEM POWER*, W	SYSTEM EFFICACY*, lm/W	CRI	CCT*, K	WEIGHT, kg
Pegasus H LED1x1900 E828 T840 R40	175	175	119	165x165	1901	13,5	141	80+	4000	1,4
Pegasus H LED1x2500 E829 T840 R40	175	175	119	165x165	2583	18,7	138	80+	4000	1,4
Pegasus H LED1x3350 E830 T840 R40	175	175	119	165x165	3478	26,5	131	80+	4000	1,4
Pegasus H LED2x1900 E831 T840 R40	350	175	119	340x165	3803	27,1	140	80+	4000	2,4
Pegasus H LED2x2500 E832 T840 R40	350	175	119	340x165	5167	37,3	139	80+	4000	2,4
Pegasus H LED2x3350 E833 T840 R40	350	175	119	340x165	6956	53,0	131	80+	4000	2,4

*Tolerance range for optical and electrical data: ±10%. Values apply to an ambient temperature of 25°C. NORTHCLIFFE LIGHTING is constantly developing and improving its products. The right is reserved to change any product specifications without prior notification

OPTIONS AVAILABLE ON REQUEST:

LED	REFLECTOR AND OPTICS	CONTROL GEAR	CONNECTION	COLOUR
T830	R24	DALI	WIE3-0.5m	RAL
T840	R40		WIE5D-0.5m	
T930			Europlug-1.5m	
T940			Europlug-3.0m	
T820 MEAT				
T831 MEAT&WHITE				
T825 BREAD				
T930 VEGETABLES				
T932 FASHION				
T931 FASHION&WHITE				
T927 NATURAL				
T930 NATURAL				
T940 NATURAL				

R24

R40

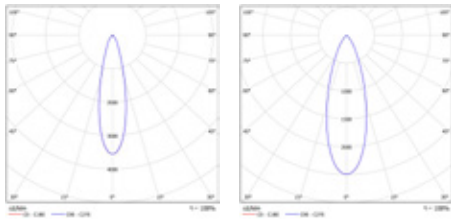

CURSA LED

Spotlights



DESCRIPTION: Recessed mounted adjustable LED spotlight
Light distribution type: direct
Optical system: faceted aluminium reflector, clear PMMA diffuser, tilting $\pm 30^\circ$, rotatable 355°
Housing: aluminium
Colour: white, RAL9016

GENERAL DATA: **Mains voltage:** 220-240V, 0/50-60Hz
LED lifetime, h: 60000/L80B10
SDCM: 3
Protection class IEC: II
Ingress protection code: IP20
Mechanical impact resistance: IK02
Operating temperature range, °C: ta 0...+35

INSTALLATION: In ceilings with cut-out openings (mounting brackets included). Push-in terminal, 2x1.5mm²

ENVIRONMENT: Indoor

APPLICATION: Retail, showroom, museum, exhibition, public place

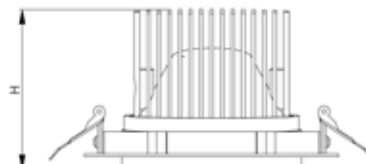
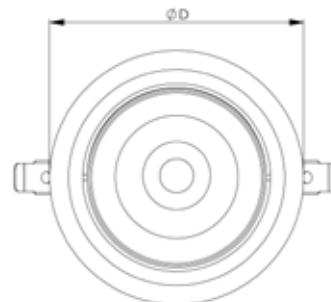

PRODUCT	DIAMETER, mm	HEIGHT, mm	CUT-OUT, mm	LUMINAIRE OUTPUT*, lm	SYSTEM POWER*, W	SYSTEM EFFICACY*, lm/W	CRI	CCT*, K	WEIGHT, kg
Cursa LED1x1950 E834 T840 R40	180	125	170	1946	13,5	144	80+	4000	1,4
Cursa LED1x2600 E835 T840 R40	180	125	170	2644	18,7	141	80+	4000	1,4
Cursa LED1x3400 E836 T840 R40	180	125	170	3559	26,5	134	80+	4000	1,4
Cursa LED1x4300 J190 T840 R40	180	125	170	4464	34,0	131	80+	4000	1,5
Cursa LED1x4850 E837 T840 R40	180	125	170	5099	40,2	127	80+	4000	1,5

*Tolerance range for optical and electrical data: $\pm 10\%$. Values apply to an ambient temperature of 25°C. NORTHCLIFFE LIGHTING is constantly developing and improving its products. The right is reserved to change any product specifications without prior notification

OPTIONS AVAILABLE ON REQUEST:

LED	REFLECTOR AND OPTICS	CONTROL GEAR	CONNECTION	COLOUR
T830	R24	DALI	WIE3-0.5m	RAL
T840	R40		WIE5D-0.5m	
T930			Europlug-1.5m	
T940			Europlug-3.0m	
T820 MEAT				
T831 MEAT&WHITE				
T825 BREAD				
T930 VEGETABLES				
T932 FASHION				
T931 FASHION&WHITE				
T927 NATURAL				
T930 NATURAL				
T940 NATURAL				

R24

R40

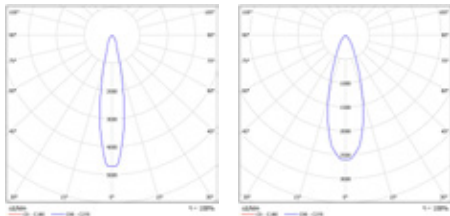

HEKA LED

Spotlights



DESCRIPTION: Recessed mounted LED spotlight with narrow trim
Light distribution type: direct
Optical system: faceted aluminium reflector, clear PMMA diffuser, narrow trim
Housing: aluminium
Colour: white, RAL9016

GENERAL DATA: Mains voltage: 220-240V, 0/50-60Hz
LED lifetime, h: 60000/L80B10
SDCM: 3
Protection class IEC: II
Ingress protection code: IP20
Mechanical impact resistance: IK02
Operating temperature range, °C: ta 0...+35

INSTALLATION: In ceilings with cut-out openings (mounting brackets included). Push-in terminal, 2x1x1.5 mm²

ENVIRONMENT: Indoor

APPLICATION: Retail, showroom, exhibition, public place

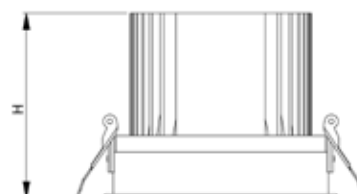
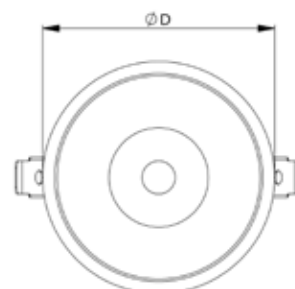

PRODUCT	DIAMETER, mm	HEIGHT, mm	CUT-OUT, mm	LUMINAIRE OUTPUT*, lm	SYSTEM POWER*, W	SYSTEM EFFICACY*, lm/W	CRI	CCT*, K	WEIGHT, kg
Heka LED1x1950 E838 T840 R40	139	117	130	1946	13,5	144	80+	4000	1,4
Heka LED1x2600 E839 T840 R40	139	117	130	2644	18,7	141	80+	4000	1,4
Heka LED1x3400 E840 T840 R40	139	117	130	3559	26,5	134	80+	4000	1,4
Heka LED1x4300 J194 T840 R40	139	117	130	4464	35,1	127	80+	4000	1,5
Heka LED1x4850 E841 T840 R40	139	117	130	5099	40,2	127	80+	4000	1,5

*Tolerance range for optical and electrical data: ±10%. Values apply to an ambient temperature of 25°C. NORTHCLIFFE LIGHTING is constantly developing and improving its products. The right is reserved to change any product specifications without prior notification

OPTIONS AVAILABLE ON REQUEST:

LED	REFLECTOR AND OPTICS	CONTROL GEAR	EMERGENCY	CONNECTION	COLOUR
T830	R24	DALI	EM3B	WIE3-0.5m	RAL
T840	R40			WIE5D-0.5m	
T930				Europlug-1.5m	
T940				Europlug-3.0m	
T927 NATURAL					
T930 NATURAL					
T940 NATURAL					

R24

R40

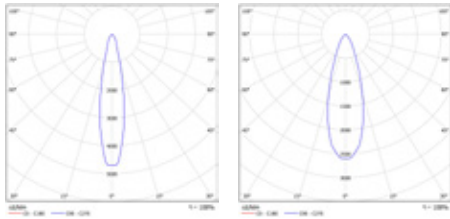



CAPHEUS B LED

Spotlights



DESCRIPTION: **Track mounted adjustable LED spotlight**
Light distribution type: direct
Optical system: faceted aluminium reflector, clear PMMA diffuser
Housing: aluminium
Colour: white, RAL9016; black, RAL9017

GENERAL DATA: **Mains voltage:** 220-240V, 0/50-60Hz
LED lifetime, h: 60000/L80B10
SDCM: 3
Protection class IEC: II
Ingress protection code: IP20
Mechanical impact resistance: IK02
Operating temperature range, °C: ta 0...+35

INSTALLATION: In 3-phase track. Track adaptor (3-phase + N) with phase selector

ENVIRONMENT: Indoor

APPLICATION: Retail, showroom, museum, exhibition, public place

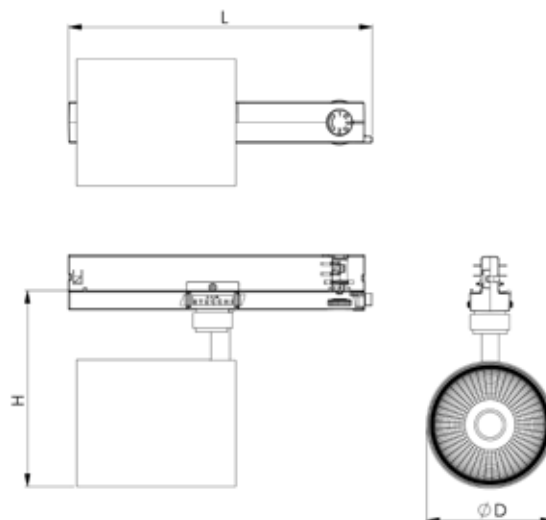

PRODUCT	LENGTH, mm	DIAMETER, mm	HEIGHT, mm	LUMINAIRE OUTPUT*, lm	SYSTEM POWER*, W	SYSTEM EFFICACY*, lm/W	CRI	CCT*, K	WEIGHT, kg
Capheus B LED1x1900 G603 T840 R40	170	82	164	1901	13,5	141	80+	4000	0,6
Capheus B LED1x2500 G604 T840 R40	170	82	164	2583	18,7	138	80+	4000	0,6
Capheus B LED1x3350 G605 T840 R40	170	82	164	3478	26,5	131	80+	4000	0,6
Capheus B LED1x4250 G606 T840 R40	234	99	180	4363	34,0	128	80+	4000	1,5
Capheus B LED1x4750 G667 T840 R40	234	99	180	4983	39,8	125	80+	4000	1,5

*Tolerance range for optical and electrical data: ±10%. Values apply to an ambient temperature of 25°C. NORTHCLIFFE LIGHTING is constantly developing and improving its products. The right is reserved to change any product specifications without prior notification

OPTIONS AVAILABLE ON REQUEST:

LED	REFLECTOR AND OPTICS	CONTROL GEAR
T830	R24	DALI ^{1 2}
T840	R40	
T930	R60	
T940		
T820 MEAT		
T831 MEAT&WHITE		
T825 BREAD		
T930 VEGETABLES		
T932 FASHION		
T931 FASHION&WHITE		
T927 NATURAL		
T930 NATURAL		
T940 NATURAL		

1 With DALI option, luminaire length: 260mm

2 For this model DALI option is not compatible with switch-control dimming functionality

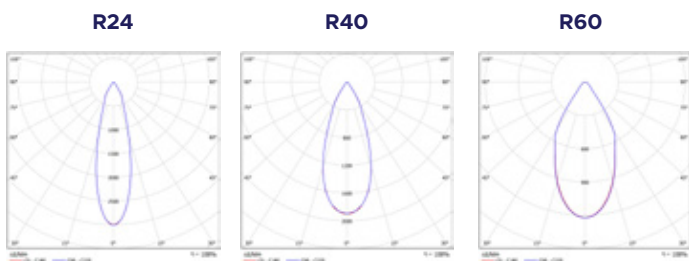

CAPHEUS S LED

Spotlights



DESCRIPTION: **Surface mounted adjustable LED spotlight**
Light distribution type: direct
Optical system: faceted aluminium reflector, clear PMMA diffuser
Housing: aluminium
Colour: white, RAL9016; black, RAL9017

GENERAL DATA: **Mains voltage:** 220-240V, 50-60Hz
LED lifetime, h: 60000/L80B10
SDCM: 3
Protection class IEC: II
Ingress protection code: IP20
Mechanical impact resistance: IK02
Operating temperature range, °C: ta 0...+35

INSTALLATION: On the ceiling. Push-in terminal, 2x1x1.5mm²

ENVIRONMENT: Indoor

APPLICATION: Retail, showroom, museum, exhibition, public place

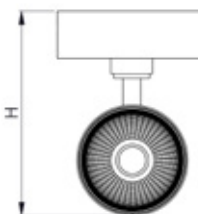
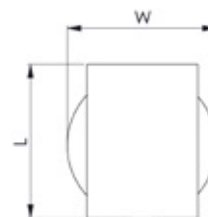

PRODUCT	LENGTH, mm	WIDTH, mm	HEIGHT, mm	LUMINAIRE OUTPUT*, lm	SYSTEM POWER*, W	SYSTEM EFFICACY*, lm/W	CRI	CCT*, K	WEIGHT, kg
Capheus S LED1x1900 G996 T840 R40	114	110	150	1901	12,9	147	80+	4000	1,1
Capheus S LED1x2500 G997 T840 R40	114	110	150	2583	18,9	137	80+	4000	1,1
Capheus S LED1x3350 G998 T840 R40	114	110	150	3478	26,8	130	80+	4000	1,1
Capheus S LED1x4250 G999 T840 R40	124	110	165	4363	34,3	127	80+	4000	1,1

*Tolerance range for optical and electrical data: ±10%. Values apply to an ambient temperature of 25°C. NORTHCLIFFE LIGHTING is constantly developing and improving its products. The right is reserved to change any product specifications without prior notification

OPTIONS AVAILABLE ON REQUEST:

LED	REFLECTOR AND OPTICS	COLOUR
T830	R24	RAL
T840	R40	
T930	R60	
T940		
T820 MEAT		
T831 MEAT&WHITE		
T825 BREAD		
T930 VEGETABLES		
T932 FASHION		
T931 FASHION&WHITE		
T927 NATURAL		
T930 NATURAL		
T940 NATURAL		

R24

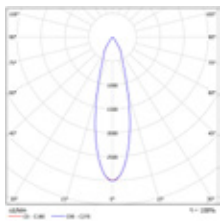

R40

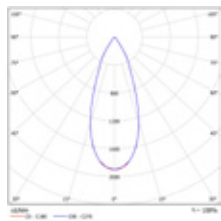

R60

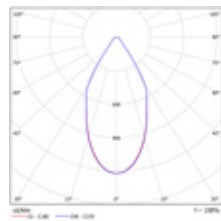

ZOOM A LED

Spotlights



DESCRIPTION: Track mounted adjustable beam LED luminaire
Light distribution type: direct
Optical system: adjustable faceted reflector, 20-60°
Housing: aluminium
Colour: white, RAL9016; black, RAL9017

GENERAL DATA: **Mains voltage:** 220-240V, 0/50-60Hz
LED lifetime, h: 60000/L80B10
SDCM: 3
Protection class IEC: II
Ingress protection code: IP20
Mechanical impact resistance: IK02
Operating temperature range, °C: ta 0...+35

INSTALLATION: In 3-phase track. Track adaptor (3-phase + N) with phase selector

ENVIRONMENT: Indoor

APPLICATION: Retail, showroom, exhibition, public place

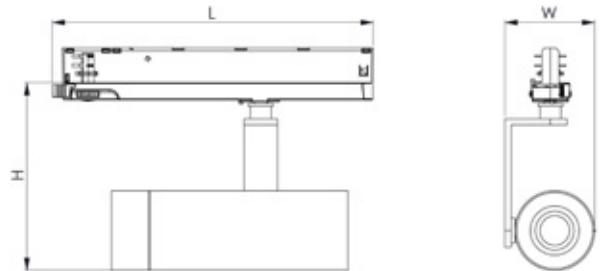

PRODUCT	LENGTH, mm	WIDTH, mm	HEIGHT, mm	LUMINAIRE OUTPUT*, lm	SYSTEM POWER*, W	SYSTEM EFFICACY*, lm/W	CRI	CCT*, K	WEIGHT, kg
Zoom A LED1x1950 J440 T840 R20-60	235	83	190	1946	13,5	144	80+	4000	1,1
Zoom A LED1x2600 J441 T840 R20-60	235	83	190	2644	18,7	141	80+	4000	1,1
Zoom A LED1x3400 J442 T840 R20-60	235	83	190	3559	26,5	134	80+	4000	1,1
Zoom A LED1x4300 J443 T840 R20-60	235	83	190	4464	34,0	131	80+	4000	1,1

*Tolerance range for optical and electrical data: ±10%. Values apply to an ambient temperature of 25°C. NORTHCLIFFE LIGHTING is constantly developing and improving its products. The right is reserved to change any product specifications without prior notification

OPTIONS AVAILABLE ON REQUEST:

LED	CONTROL GEAR
T830	T930 VEGETABLES DALI ¹
T840	T932 FASHION ROTARY DIM ²
T930	T931 FASHION&WHITE
T940	T927 NATURAL
T820 MEAT	T930 NATURAL
T831 MEAT&WHITE	T940 NATURAL
T825 BREAD	

R20-60

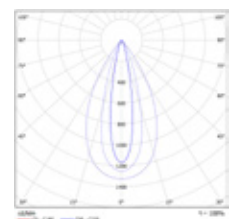

1 For this model DALI option is not compatible with switch-control dimming functionality
 2 Rotary DIM option not applicable for model: J443



SANTA LED

Spotlights



DESCRIPTION: **A cylindrical LED track light with symmetrical faceted reflector designed for the accent lighting**
Light distribution type: direct
Optical system: faceted aluminium reflector, 36° (standard) and 24° beam angles
Housing: aluminium
Colour: white, RAL9016; black, RAL9017

GENERAL DATA: **Mains voltage:** 220-240V, 0/50-60Hz
LED lifetime, h: 60000/L80B10
SDCM: 3
Protection class IEC: II
Ingress protection code: IP20
Mechanical impact resistance: IK02
Operating temperature range, °C: ta 0...+35

INSTALLATION: Surface luminaire is designed to be fixed into 4/6-conductors surface/recessed tracks. Track adaptor (3-phase + N) with phase selector

ENVIRONMENT: Indoor

APPLICATION: Retail, showroom, museum, exhibition, public place

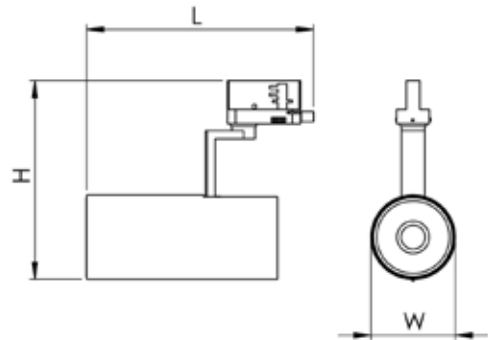

PRODUCT	LENGTH, mm	WIDTH, mm	HEIGHT, mm	LUMINAIRE OUTPUT*, lm	SYSTEM POWER*, W	SYSTEM EFFICACY*, lm/W	CRI	CCT*, K	WEIGHT, kg
Santa LED1x1900 J670 T840 R36	290	83	145	1901	13,5	141	80+	4000	1,3
Santa LED1x2500 J671 T840 R36	290	83	145	2583	18,7	138	80+	4000	1,3
Santa LED1x3350 J672 T840 R36	290	83	145	3478	26,5	131	80+	4000	1,3

*Tolerance range for optical and electrical data: ±10%. Values apply to an ambient temperature of 25°C. NORTHCLIFFE LIGHTING is constantly developing and improving its products. The right is reserved to change any product specifications without prior notification

OPTIONS AVAILABLE ON REQUEST:

LED	REFLECTOR AND OPTICS	CONTROL GEAR
T830	R24	DALI ¹ 2
T840		
T930		
T940		
T820 MEAT		
T831 MEAT&WHITE		
T825 BREAD		
T930 VEGETABLES		
T932 FASHION		
T931 FASHION&WHITE		

R40

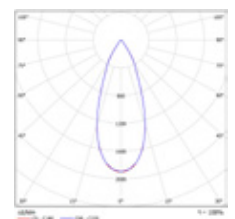

1 DALI option available with length 260mm

2 For this model DALI option is not compatible with switch-control dimming functionality

SANTA E LED

Spotlights



DESCRIPTION: Track mounted adjustable LED spotlight
Light distribution type: direct
Optical system: faceted aluminium reflector, clear PMMA diffuser
Housing: thermoplastic
Colour: white, RAL9016; black, RAL9005

GENERAL DATA: **Mains voltage:** 220-240V, 50-60Hz
LED lifetime, h: 50000/L80B10
SDCM: 3
Protection class IEC: I
Ingress protection code: IP20
Mechanical impact resistance: IK02
Operating temperature range, °C: ta 0...+35

INSTALLATION: In 3-phase track. Track adaptor (3-phase + N) with phase selector

ENVIRONMENT: Indoor

APPLICATION: Retail, showroom, museum, exhibition, public place

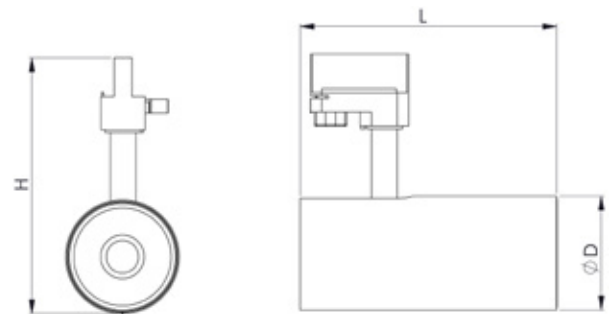

PRODUCT	LENGTH, mm	WIDTH, mm	HEIGHT, mm	LUMINAIRE OUTPUT*, lm	SYSTEM POWER*, W	SYSTEM EFFICACY*, lm/W	CRI	CCT*, K	WEIGHT, kg
Santa E LED1x1750 J652 T840 R40	185	80	185	1750	17,7	99	80+	4000	0,8
Santa E LED1x2500 J653 T840 R40	210	90	195	2913	28,5	102	80+	4000	1,1

*Tolerance range for optical and electrical data: ±10%. Values apply to an ambient temperature of 25°C. NORTHCLIFFE LIGHTING is constantly developing and improving its products. The right is reserved to change any product specifications without prior notification

R40

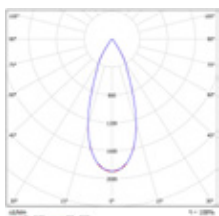

SHARQI A LED

Spotlights



DESCRIPTION: Recessed mounted adjustable LED spotlight
Light distribution type: direct
Optical system: faceted aluminium reflector, clear PMMA diffuser
Housing: aluminium
Colour: white, RAL9016; black, RAL9017

GENERAL DATA: **Mains voltage:** 220-240V, 50-60Hz (220-240V, 0/50-60Hz for model G670)
LED lifetime, h: 60000/L80B10
SDCM: 3
Protection class IEC: II
Ingress protection code: IP20
Mechanical impact resistance: IK02
Operating temperature range, °C: ta 0...+35

INSTALLATION: In ceilings with cut-out openings (mounting brackets included). Push-in terminal, 2x1x1.5mm²

ENVIRONMENT: Indoor

APPLICATION: Retail, showroom, museum, exhibition, public place

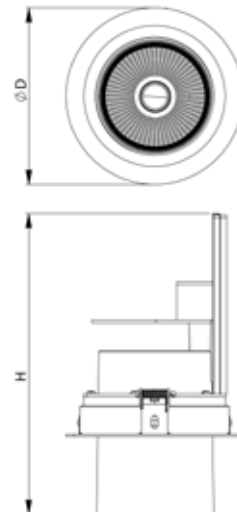

PRODUCT	DIAMETER, mm	HEIGHT, mm	CUT-OUT, mm	LUMINAIRE OUTPUT*, lm	SYSTEM POWER*, W	SYSTEM EFFICACY*, lm/W	CRI	CCT*, K	WEIGHT, kg
Sharqi A LED1x1900 G668 T840 R40 RAL9016	125	170	118	1924	13,5	143	80+	4000	0,9
Sharqi A LED1x2550 G669 T840 R40 RAL9016	125	170	118	2613	19,8	132	80+	4000	0,9
Sharqi A LED1x3350 G670 T840 R40 RAL9016	125	170	118	3518	27,1	130	80+	4000	0,9

*Tolerance range for optical and electrical data: ±10%. Values apply to an ambient temperature of 25°C. NORTHCLIFFE LIGHTING is constantly developing and improving its products. The right is reserved to change any product specifications without prior notification

OPTIONS AVAILABLE ON REQUEST:

LED	REFLECTOR AND OPTICS	CONTROL GEAR	CONNECTION
T830	R24	DALI	WIE3-0.5m
T840	R40		WIE5D-0.5m
T930	R60		Europlug-1.5m
T940			Europlug-3.0m
T820 MEAT			
T831 MEAT&WHITE			
T825 BREAD			
T930 VEGETABLES			
T932 FASHION			
T931 FASHION&WHITE			
T927 NATURAL			
T930 NATURAL			
T940 NATURAL			

R24

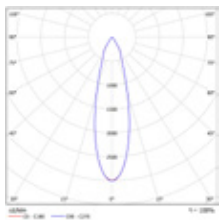

R40

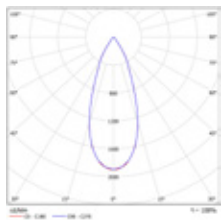

R60

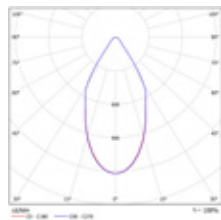

KALI LED

Spotlights



DESCRIPTION: Track mounted adjustable LED spotlight

Light distribution type: direct
Optical system: faceted aluminium reflector, 60°, tempered glass diffuser
Housing: aluminium
Colour: white, RAL9016; black, RAL9017

GENERAL DATA: **Mains voltage:** 220-240V, 0/50-60Hz
LED lifetime, h: 60000/L80B10
SDCM: 3

Protection class IEC: I
Ingress protection code: IP20
Mechanical impact resistance: IK02
Operating temperature range, °C: ta 0...+35

INSTALLATION: In 3-phase track. Track adaptor (3-phase + N) with phase selector

ENVIRONMENT: Indoor

APPLICATION: Retail, showroom, exhibition, public place

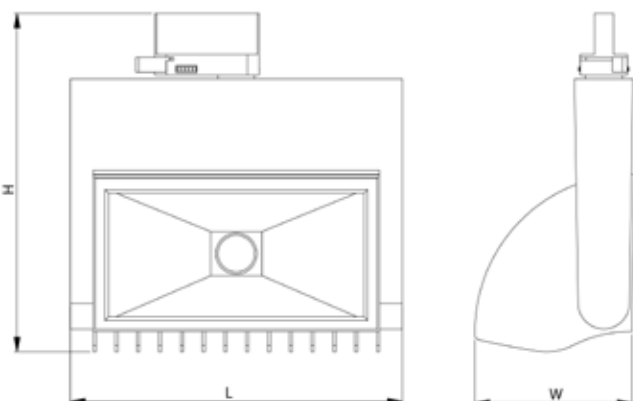

PRODUCT	LENGTH, mm	WIDTH, mm	HEIGHT, mm	LUMINAIRE OUTPUT*, lm	SYSTEM POWER*, W	SYSTEM EFFICACY*, lm/W	CRI	CCT*, K	WEIGHT, kg
Kali LED1x1900 D749 T840 R60	226	107	248	1924	13,1	147	80+	4000	2,6
Kali LED1x2550 D750 T840 R60	226	107	248	2613	19,5	134	80+	4000	2,6
Kali LED1x3350 D751 T840 R60	226	107	248	3518	27,1	130	80+	4000	2,6
Kali LED1x4250 J198 T840 R60	226	107	248	4414	35,1	126	80+	4000	2,6
Kali LED1x4800 D789 T840 R60	226	107	248	5041	42,1	120	80+	4000	2,6
Kali LED1x5250 D748 T840 R60	226	107	248	5606	47,1	119	80+	4000	2,6

*Tolerance range for optical and electrical data: ±10%. Values apply to an ambient temperature of 25°C. NORTHCLIFFE LIGHTING is constantly developing and improving its products. The right is reserved to change any product specifications without prior notification

Note - standard tracks and adapters RAL colours: RAL9010, RAL9005, RAL7035

OPTIONS AVAILABLE ON REQUEST:

LED	CONTROL GEAR
T830	DALI ¹
T840	
T930	
T940	
T820 MEAT	
T831 MEAT&WHITE	
T825 BREAD	
T930 VEGETABLES	
T932 FASHION	
T931 FASHION&WHITE	
T927 NATURAL	
T930 NATURAL	
T940 NATURAL	

1 For this model DALI option is not compatible with switch-control dimming functionality

R60

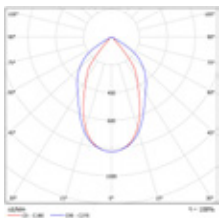

DELPHINUS LED

Spotlights



DESCRIPTION: **Recessed mounted adjustable LED spotlight**
Light distribution type: direct
Optical system: faceted aluminium reflector, 60°, tilting 90°, tempered glass diffuser
Housing: aluminium
Colour: white, RAL9016

GENERAL DATA: **Mains voltage:** 220-240V, 50-60Hz (220-240V, 0/50-60Hz for models D746, J206, D787)
LED lifetime, h: 60000/L80B10
SDCM: 3
Protection class IEC: II
Ingress protection code: IP40
Mechanical impact resistance: IK02
Operating temperature range, °C: ta 0...+35

INSTALLATION: In ceilings with cut-out openings (mounting brackets included). Push-in terminal, 2x1x1.5mm²

ENVIRONMENT: Indoor

APPLICATION: Retail, showroom, exhibition, public place

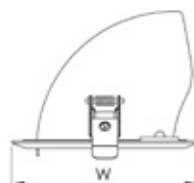
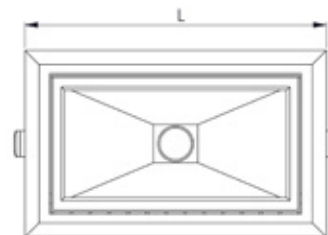

PRODUCT	LENGTH, mm	WIDTH, mm	HEIGHT, mm	CUT-OUT, mm	LUMINAIRE OUTPUT*, lm	SYSTEM POWER*, W	SYSTEM EFFICACY*, lm/W	CRI	CCT*, K	WEIGHT, kg
Delphinus LED1x1900 D744 T840 R60	236	146	107	223x133	1924	13,5	143	80+	4000	2,5
Delphinus LED1x2550 D745 T840 R60	236	146	107	223x133	2613	19,8	132	80+	4000	2,5
Delphinus LED1x3350 D746 T840 R60	236	146	107	223x133	3518	27,1	130	80+	4000	2,5
Delphinus LED1x4250 J206 T840 R60	236	146	107	223x133	4414	35,1	126	80+	4000	2,5
Delphinus LED1x4800 D787 T840 R60	236	146	107	223x133	5041	42,1	120	80+	4000	2,5
Delphinus LED1x5250 D747 T840 R60	236	146	107	223x133	5606	46,6	120	80+	4000	2,5

*Tolerance range for optical and electrical data: ±10%. Values apply to an ambient temperature of 25°C. NORTHCLIFFE LIGHTING is constantly developing and improving its products. The right is reserved to change any product specifications without prior notification

OPTIONS AVAILABLE ON REQUEST:

LED	CONTROL GEAR	CONNECTION	COLOUR
T830	DALI	WIE3-0.5m	RAL
T840		WIE5D-0.5m	
T930		Europlug-1.5m	
T940		Europlug-3.0m	
T820 MEAT			
T831 MEAT&WHITE			
T825 BREAD			
T930 VEGETABLES			
T932 FASHION			
T931 FASHION&WHITE			
T927 NATURAL			
T930 NATURAL			
T940 NATURAL			

STANDARD

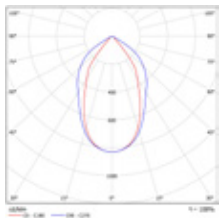

AQUARIUS A LED

Spotlights



DESCRIPTION: Recessed mounted adjustable LED spotlight
Light distribution type: direct
Optical system: faceted aluminium reflector, 60°, tempered glass diffuser
Housing: aluminium
Colour: white, RAL9016

GENERAL DATA: Mains voltage: 220-240V, 0/50-60Hz
 LED lifetime, h: 60000/L80B10
 SDCM: 3
 Protection class IEC: II
 Ingress protection code: IP40
 Mechanical impact resistance: IK02
 Operating temperature range, °C: ta 0...+35

INSTALLATION: In ceilings with cut-out openings (mounting brackets included). Push-in terminal, 2x1x1.5mm²

ENVIRONMENT: Indoor

APPLICATION: Retail, showroom, exhibition, public place

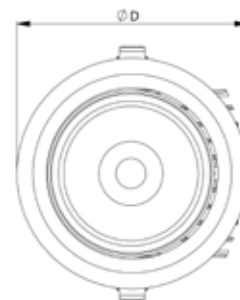

PRODUCT	DIAMETER, mm	HEIGHT, mm	CUT-OUT, mm	LUMINAIRE OUTPUT*, lm	SYSTEM POWER*, W	SYSTEM EFFICACY*, lm/W	CRI	CCT*, K	WEIGHT, kg
Aquarius A LED1x1850 E826 T840 R60	180	147	170	1857	13,5	138	80+	4000	2,5
Aquarius A LED1x2450 E827 T840 R60	180	147	170	2523	18,7	135	80+	4000	2,5
Aquarius A LED1x3250 D784 T840 R60	180	147	170	3397	26,5	128	80+	4000	2,5
Aquarius A LED1x4150 J210 T840 R60	180	147	170	4261	35,1	121	80+	4000	2,5
Aquarius A LED1x4650 D785 T840 R60	180	147	170	4867	40,2	121	80+	4000	2,5
Aquarius A LED1x5050 D786 T840 R60	180	147	170	5413	46,6	116	80+	4000	2,5

*Tolerance range for optical and electrical data: ±10%. Values apply to an ambient temperature of 25°C. NORTHCLIFFE LIGHTING is constantly developing and improving its products. The right is reserved to change any product specifications without prior notification

OPTIONS AVAILABLE ON REQUEST:

LED	CONTROL GEAR	CONNECTION	COLOUR
T830	DALI	WIE3-0.5m	RAL
T840		WIE5D-0.5m	
T930		Europlug-1.5m	
T940		Europlug-3.0m	
T820 MEAT			
T831 MEAT&WHITE			
T825 BREAD			
T930 VEGETABLES			
T932 FASHION			
T931 FASHION&WHITE			
T927 NATURAL			
T930 NATURAL			
T940 NATURAL			

R60

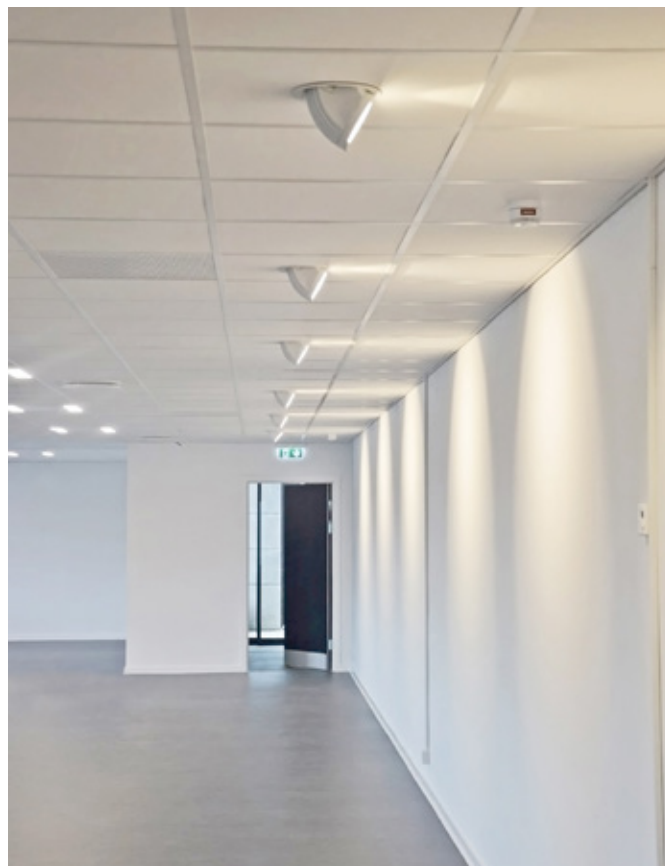
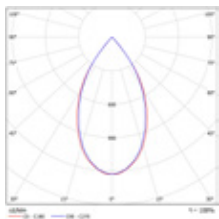



ANTLIA T LED

Spotlights



DESCRIPTION: **Track mounted LED downlight**
Light distribution type: direct
Optical system: opal polycarbonate diffuser
Housing: aluminium
Colour: white, RAL9016; black, RAL9005

GENERAL DATA: **Mains voltage:** 220-240V, 0/50-60Hz
LED lifetime, h: 60000/L80B10
SDCM: 3
Protection class IEC: I
Ingress protection code: IP20
Mechanical impact resistance: IK02
Operating temperature range, °C: ta 0...+35

INSTALLATION: In 3-phase track. Track adaptor (3-phase + N) with phase selector

ENVIRONMENT: Indoor

APPLICATION: Retail, showroom, exhibition, public place

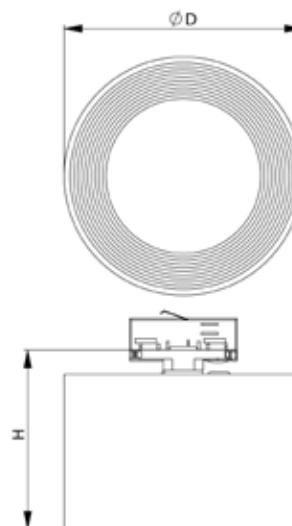

PRODUCT	DIAMETER, mm	HEIGHT, mm	LUMINAIRE OUTPUT*, lm	SYSTEM POWER*, W	SYSTEM EFFICACY*, lm/W	CRI	CCT*, K	WEIGHT, kg
Antlia T LED1x1450 D948 T840 OP	200	150	1443	11,7	123	80+	4000	1,0
Antlia T LED1x2000 D949 T840 OP	200	150	2023	16,2	125	80+	4000	1,0
Antlia T LED1x2700 D950 T840 OP	200	150	2753	23,0	120	80+	4000	1,0

*Tolerance range for optical and electrical data: ±10%. Values apply to an ambient temperature of 25°C. NORTHCLIFFE LIGHTING is constantly developing and improving its products. The right is reserved to change any product specifications without prior notification

OPTIONS AVAILABLE ON REQUEST:

LED	CONTROL GEAR	COLOUR
T830	DALI ¹	RAL ²
T840		

1 For this model DALI option is not compatible with switch-control dimming functionality

2 Standard tracks and adapters RAL colours: RAL9010, RAL9005, RAL7035

OP

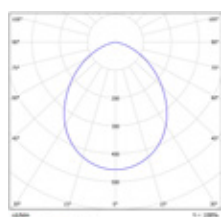



SPICA LED

Spotlights



DESCRIPTION: **Track mounted linear LED luminaire**
Light distribution type: direct
Optical system: lenses
Housing: steel
Colour: white, RAL9003S; light grey, RAL7035S; black, RAL9005S

GENERAL DATA: **Mains voltage:** 220-240V, 0/50-60Hz
LED lifetime, h: 100000/L80B10
SDCM: 3
Protection class IEC: I
Ingress protection code: IP20
Mechanical impact resistance: IK02
Operating temperature range, °C: ta 0...+35

INSTALLATION: In 3-phase track. Track adaptor (3-phase + N) with phase selector

ENVIRONMENT: Indoor

APPLICATION: Retail, showroom, exhibition, public place

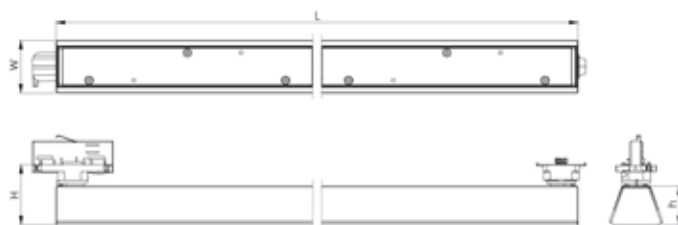

PRODUCT	LENGTH, mm	WIDTH, mm	HEIGHT, mm	LUMINAIRE OUTPUT*, lm	SYSTEM POWER*, W	SYSTEM EFFICACY*, lm/W	CRI	CCT*, K	WEIGHT, kg
Spica LED1x1900 G546 T840 L75	574	59	70	1898	11,7	161	80+	4000	1,3
Spica LED1x2800 G547 T840 L75	574	59	70	2762	15,9	157	80+	4000	1,3
Spica LED1x3800 G548 T840 L75	574	59	70	3777	21,8	170	80+	4000	1,3
Spica LED1x2850 G549 T840 L75	856	59	70	2847	16,9	165	80+	4000	1,7
Spica LED1x4150 G550 T840 L75	856	59	70	4142	22,8	161	80+	4000	1,7
Spica LED1x5700 G551 T840 L75	856	59	70	5665	31,6	176	80+	4000	1,7
Spica LED1x3800 G552 T840 L75	1137	59	70	3796	21,8	170	80+	4000	2,1
Spica LED1x5550 G553 T840 L75	1137	59	70	5523	29,7	163	80+	4000	2,1
Spica LED1x7600 G554 T840 L75	1137	59	70	7554	41,2	178	80+	4000	2,1

*Tolerance range for optical and electrical data: ±10%. Values apply to an ambient temperature of 25°C. NORTHCLIFFE LIGHTING is constantly developing and improving its products. The right is reserved to change any product specifications without prior notification

Note - for models G546; G549; G552 - only every second LED lights up

OPTIONS AVAILABLE ON REQUEST:

LED	REFLECTOR AND OPTICS	CONTROL GEAR	COLOUR
T830	L30	DALI ^{1 2}	RAL ³
T840	L40x75		
	L75		
	L75W		
	L90W		
	L100		
	L1A18		
	L2A25		

1 Minimum dimming level for models: G546; G549 is 1%. For other models - 10%

2 For this model DALI option is not compatible with switch-control dimming functionality

3 Standard tracks and adapters RAL colours: RAL9010, RAL9005, RAL7035

L30

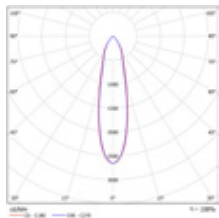

L40x75

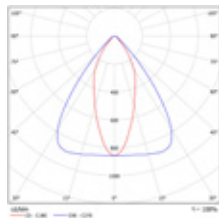

L75

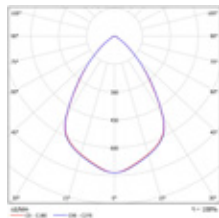

L75W

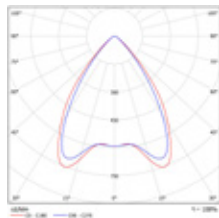

L90W

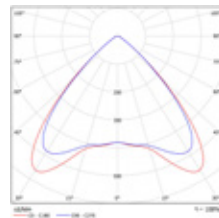

L100

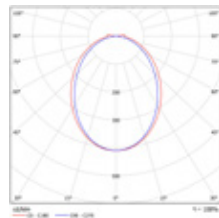

L1A18

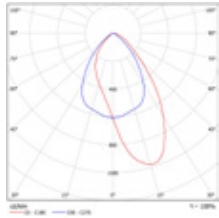

L2A25

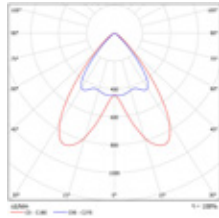

SPICA T LED

Spotlights



DESCRIPTION: Track mounted linear LED luminaire
Light distribution type: direct
Optical system: lenses
Housing: steel
Colour: white, RAL9003S; light grey, RAL7035S; black, RAL9005S

GENERAL DATA: **Mains voltage:** 220-240V, 0/50-60Hz
LED lifetime, h: 100000/L80B10
SDCM: 3
Protection class IEC: I
Ingress protection code: IP20
Mechanical impact resistance: IK02
Operating temperature range, °C: ta 0...+35

INSTALLATION: In 3-phase track. Track adaptor (3-phase + N) with phase selector

ENVIRONMENT: Indoor

APPLICATION: Retail, showroom, exhibition, public place

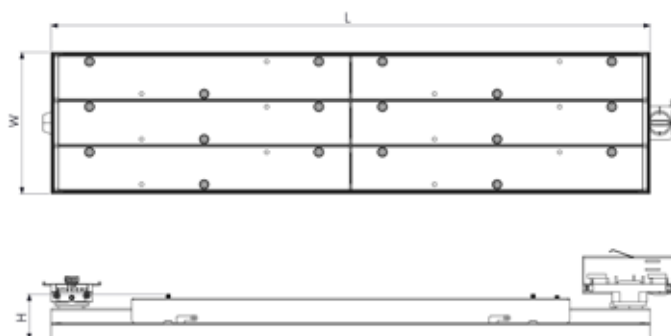

PRODUCT	LENGTH, mm	WIDTH, mm	HEIGHT, mm	LUMINAIRE OUTPUT*, lm	SYSTEM POWER*, W	SYSTEM EFFICACY*, lm/W	CRI	CCT*, K	WEIGHT, kg
Spica T LED1x8300 J188 T840 L75	575	136	54	8285	44,1	188	80+	4000	2,0
Spica T LED1x11350 J189 T840 L75	575	136	54	11331	61,8	183	80+	4000	2,0

*Tolerance range for optical and electrical data: ±10%. Values apply to an ambient temperature of 25°C. NORTHCLIFFE LIGHTING is constantly developing and improving its products. The right is reserved to change any product specifications without prior notification

OPTIONS AVAILABLE ON REQUEST:

LED	REFLECTOR AND OPTICS	CONTROL GEAR	COLOUR
T830	L30	DALI ¹	RAL ²
T840	L40x75		
	L75		
	L75W		
	L90W		
	L100		
	L1A18		
	L2A25		

¹ For this model DALI option is not compatible with switch-control dimming functionality

² Standard tracks and adapters RAL colours: RAL9010, RAL9005, RAL7035

L30

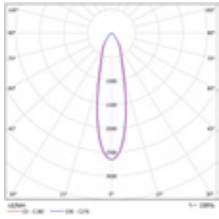

L40x75

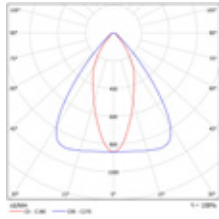

L75

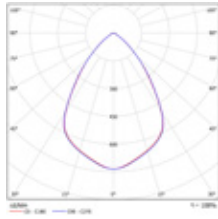

L75W

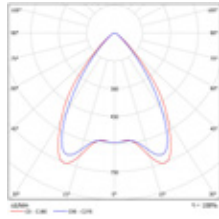

L90W

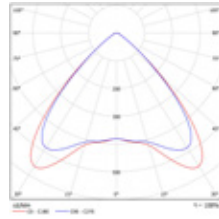

L100

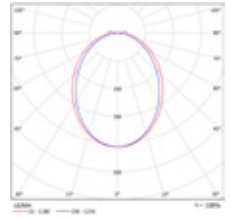

L1A18

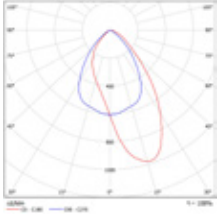

L2A25

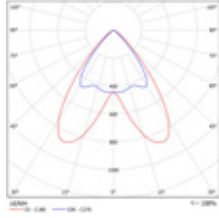

SPICA I LED

Spotlights



DESCRIPTION: Track mounted low profile linear LED luminaire
Light distribution type: direct
Optical system: lenses
Housing: steel
Colour: white, RAL9003S; light grey, RAL7035S; black, RAL9005S

GENERAL DATA: **Mains voltage:** 220-240V, 50-60Hz
LED lifetime, h: 100000/L80B10
SDCM: 3
Protection class IEC: II
Ingress protection code: IP20
Mechanical impact resistance: IK02
Operating temperature range, °C: ta 0...+35

INSTALLATION: In 3-phase track. Track adaptor (3-phase + N) with phase selector

ENVIRONMENT: Indoor

APPLICATION: Retail, showroom, exhibition, public place

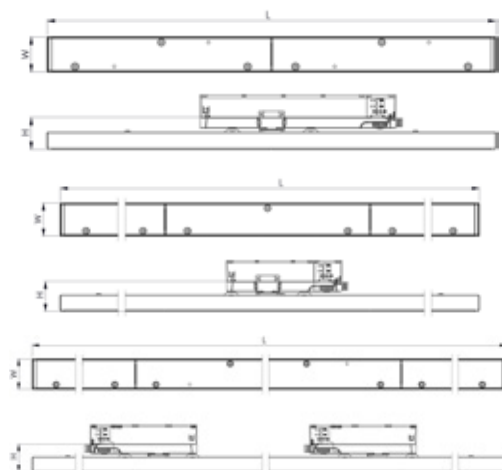

PRODUCT	LENGTH, mm	WIDTH, mm	HEIGHT, mm	LUMINAIRE OUTPUT*, lm	SYSTEM POWER*, W	SYSTEM EFFICACY*, lm/W	CRI	CCT*, K	WEIGHT, kg
Spica I LED1x1900 J627 T840 L75	573	45	42	1898	11,3	168	80+	4000	0,8
Spica I LED1x2250 J628 T840 L75	573	45	42	2241	13,1	171	80+	4000	0,8
Spica I LED1x2800 J629 T840 L75	573	45	42	2761	16,3	169	80+	4000	0,8
Spica I LED1x3300 J630 T840 L75	573	45	42	3284	19,4	169	80+	4000	0,8
Spica I LED1x3800 J631 T840 L75	573	45	42	3777	22,5	168	80+	4000	0,8
Spica I LED1x2850 J632 T840 L75	854	45	42	2847	17,0	167	80+	4000	1,0
Spica I LED1x3400 J633 T840 L75	854	45	42	3362	19,6	172	80+	4000	1,0
Spica I LED1x4150 J634 T840 L75	854	45	42	4142	24,4	170	80+	4000	1,0
Spica I LED1x4950 J635 T840 L75	854	45	42	4925	29,2	169	80+	4000	1,0
Spica I LED1x5700 J636 T840 L75	854	45	42	5666	33,8	168	80+	4000	1,0
Spica I LED1x3800 J637 T840 L75	1135	45	42	3796	22,6	168	80+	4000	1,4
Spica I LED1x4500 J638 T840 L75	1135	45	42	4483	26,1	172	80+	4000	1,4
Spica I LED1x5550 J639 T840 L75	1135	45	42	5523	32,6	169	80+	4000	1,4
Spica I LED1x6600 J640 T840 L75	1135	45	42	6567	38,9	169	80+	4000	1,4
Spica I LED1x7600 J641 T840 L75	1135	45	42	7554	45,0	168	80+	4000	1,4
Spica I LED1x4750 J642 T840 L75	1416	45	42	4745	28,3	168	80+	4000	1,7
Spica I LED1x5650 J643 T840 L75	1416	45	42	5604	32,7	171	80+	4000	1,7

PRODUCT	LENGTH, mm	WIDTH, mm	HEIGHT, mm	LUMINAIRE OUTPUT*, lm	SYSTEM POWER*, W	SYSTEM EFFICACY*, lm/W	CRI	CCT*, K	WEIGHT, kg
Spica I LED1x6950 J644 T840 L75	1416	45	42	6903	40,7	170	80+	4000	1,7
Spica I LED1x8250 J645 T840 L75	1416	45	42	8209	48,6	169	80+	4000	1,7
Spica I LED1x9450 J646 T840 L75	1416	45	42	9443	56,3	168	80+	4000	1,7
Spica I LED1x5700 J647 T840 L75	1697	45	42	5694	33,9	168	80+	4000	1,9
Spica I LED1x6750 J648 T840 L75	1697	45	42	6724	37,8	178	80+	4000	1,9
Spica I LED1x8300 J649 T840 L75	1697	45	42	8284	47,7	174	80+	4000	1,9
Spica I LED1x9900 J650 T840 L75	1697	45	42	9851	57,6	171	80+	4000	1,9
Spica I LED1x11350 J651 T840 L75	1697	45	42	11331	67,5	168	80+	4000	1,9

*Tolerance range for optical and electrical data: ±10%. Values apply to an ambient temperature of 25°C. NORTHCLIFFE LIGHTING is constantly developing and improving its products. The right is reserved to change any product specifications without prior notification

Note - for versions: J627; J632; J637; J642; J647 only every second LED lights up

OPTIONS AVAILABLE ON REQUEST:

LED	REFLECTOR AND OPTICS	CONTROL GEAR	COLOUR
T830	L30	DALI ^{1 2}	RAL ⁴
T840	L40x75	T ³	
T930	L75	L1A18	
T940	L75W	L2A25	

- 1 DALI option in models J637...J651 uses 2 DALI addresses
- 2 For this model DALI option is not compatible with switch-control dimming functionality
- 3 T option is not applicable for models J627...J636
- 4 Standard tracks and adapters RAL colours: RAL9010, RAL9005, RAL7035

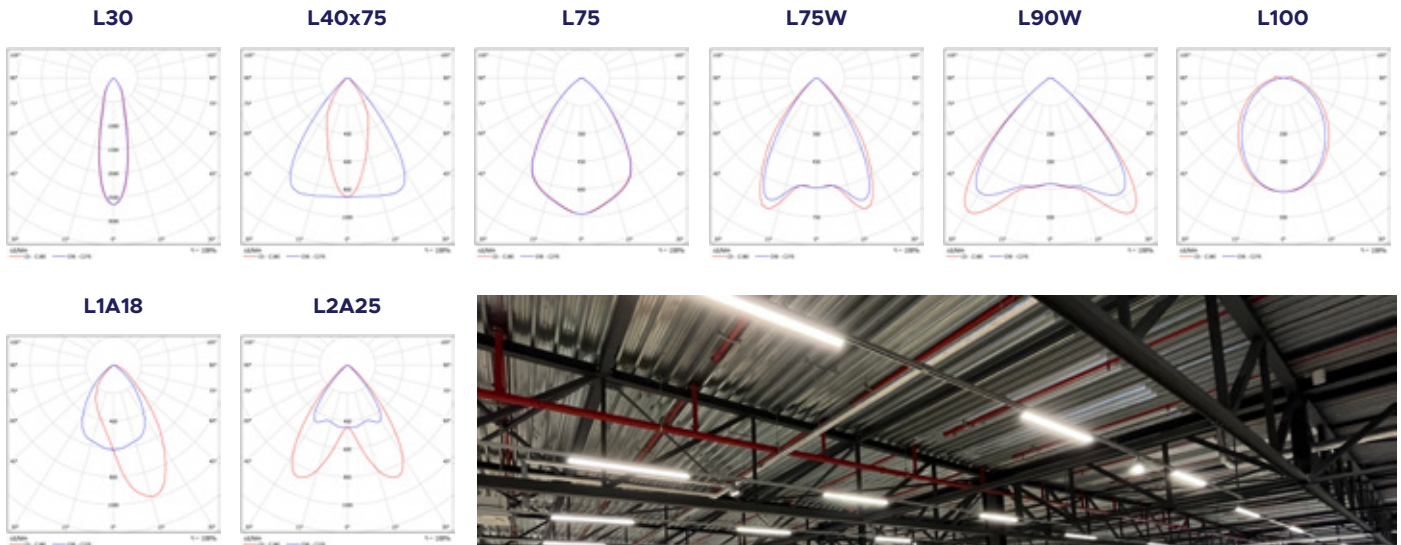

VILLY I LED

Spotlights



DESCRIPTION: **Suspended LED spotlight**
Light distribution type: direct
Optical system: faceted aluminium reflector, clear PMMA diffuser
Housing: aluminium
Colour: white, RAL9016; black, RAL9017

GENERAL DATA: **Mains voltage:** 220-240V, 50-60Hz (220-240V, 0/50-60Hz for model J564)
LED lifetime, h: 60000/L80B10
SDCM: 3
Protection class IEC: I
Ingress protection code: IP20
Mechanical impact resistance: IK02
Operating temperature range, °C: ta 0...+35

INSTALLATION: Suspended or surface (cap and cable included). Cable, 1.1m, 3x0.75mm²

ENVIRONMENT: Indoor

APPLICATION: Hotel, retail, showroom, exhibition, public place



PRODUCT	DIAMETER, mm	HEIGHT, mm	LUMINAIRE OUTPUT*, lm	SYSTEM POWER*, W	SYSTEM EFFICACY*, lm/W	CRI	CCT*, K	WEIGHT, kg
Villy I LED1x2300 J562 T840 R45	77	245	2276	15,4	148	80+	4000	1,1
Villy I LED1x2750 J563 T840 R45	77	245	2734	19,3	142	80+	4000	1,1
Villy I LED1x3250 J564 T840 R45	77	245	3217	22,9	140	80+	4000	1,1

*Tolerance range for optical and electrical data: ±10%. Values apply to an ambient temperature of 25°C. NORTHCLIFFE LIGHTING is constantly developing and improving its products. The right is reserved to change any product specifications without prior notification

OPTIONS AVAILABLE ON REQUEST:

LED	REFLECTOR AND OPTICS	CONTROL GEAR	CONNECTION	OTHER	COLOUR
T830	T930 VEGETABLES	DALI ¹	TRACK	SR	RAL
T840	T932 FASHION				
T930	T931 FASHION&WHITE				
T940	T927 NATURAL				
T820 MEAT	T930 NATURAL				
T831 MEAT&WHITE	T940 NATURAL				
T825 BREAD					

¹ Stucchi tracks are not compatible with switch-control dimming

R24

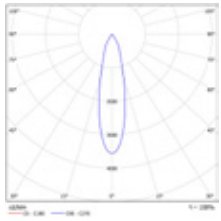

R32

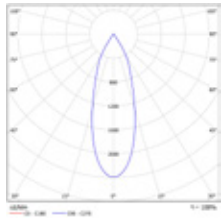

R45

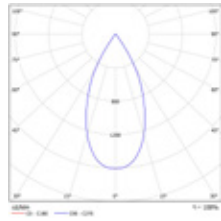

R55

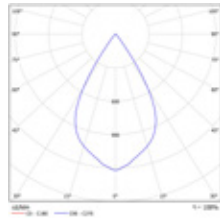

CHARA LED

Spotlights



DESCRIPTION: **Suspended LED spotlight**
Light distribution type: direct
Optical system: faceted aluminium reflector, clear PMMA diffuser
Housing: aluminium
Colour: black, RAL9005S; white, RAL9003S

GENERAL DATA: **Mains voltage:** 220-240V, 0/50-60Hz
LED lifetime, h: 60000/L80B10
SDCM: 3
Protection class IEC: I
Ingress protection code: IP20
Mechanical impact resistance: IK02
Operating temperature range, °C: ta 0...+35

INSTALLATION: Suspended (cap and cable included). Cable, 1.5m, 3x0.75mm²

ENVIRONMENT: Indoor

APPLICATION: Hotel, retail, showroom, exhibition, public place



PRODUCT	DIAMETER, mm	HEIGHT, mm	LUMINAIRE OUTPUT*, lm	SYSTEM POWER*, W	SYSTEM EFFICACY*, lm/W	CRI	CCT*, K	WEIGHT, kg
Chara LEDx1500 J216 T840 R60 RAL9005	315	300	1459	13,4	109	80+	4000	1,3
Chara LEDx2000 J217 T840 R60 RAL9005	315	300	1983	19,5	102	80+	4000	1,3
Chara LEDx2700 J218 T840 R60 RAL9005	315	300	2669	27,1	98	80+	4000	1,3
Chara LEDx3350 J219 T840 R60 RAL9005	315	300	3348	35,1	95	80+	4000	1,3
Chara LEDx3850 J220 T840 R60 RAL9005	315	300	3824	42,1	91	80+	4000	1,3

*Tolerance range for optical and electrical data: ±10%. Values apply to an ambient temperature of 25°C. NORTHCLIFFE LIGHTING is constantly developing and improving its products. The right is reserved to change any product specifications without prior notification

OPTIONS AVAILABLE ON REQUEST:

LED	REFLECTOR AND OPTICS	CONTROL GEAR	CONNECTION	COLOUR
T830	R15	DALI ¹	TRACK ²	RAL
T840	R24			
T930	R32			
T940	R60			
T820 MEAT				
T831 MEAT&WHITE				
T825 BREAD				
T930 VEGETABLES				
T932 FASHION				
T931 FASHION&WHITE				
T927 NATURAL				
T930 NATURAL				
T940 NATURAL				

1 Stucchi tracks are not compatible with switch-control dimming

2 With Track option, IEC protection class is II

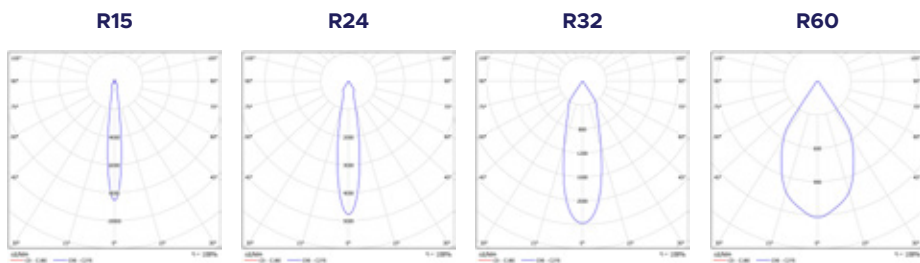

TRACK SYSTEM AND PARTS

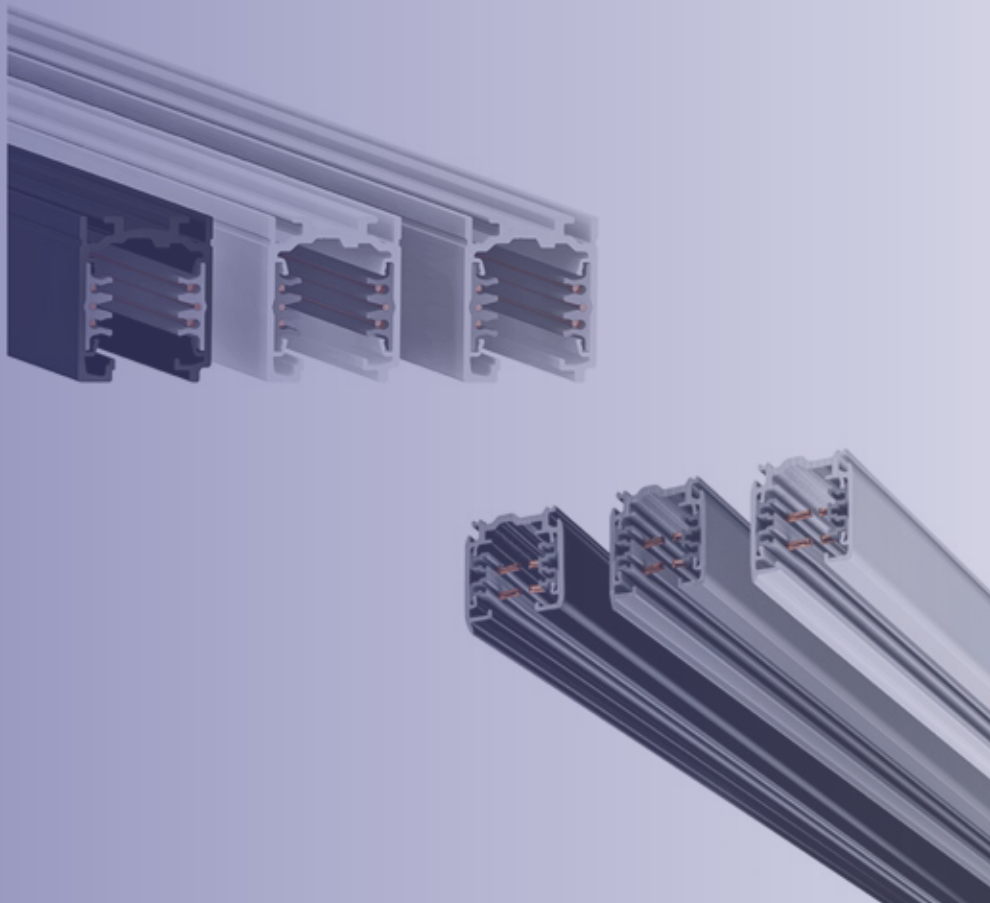

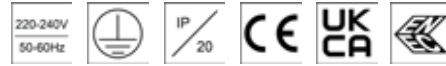

ONETRACK® is the new product range for track lighting based on EUROSTANDARD PLUS® platform. This new state-of-the-art platform is for use in lighting projects employing controllable and fixed output systems. As the platform makes upgrading possible at any moment, non-controllable installations are future proof. The system flexible communication lines ensure its use in future Human Centric Lighting systems.

The EUROSTANDARD PLUS® 6 conductors track connection diagram:

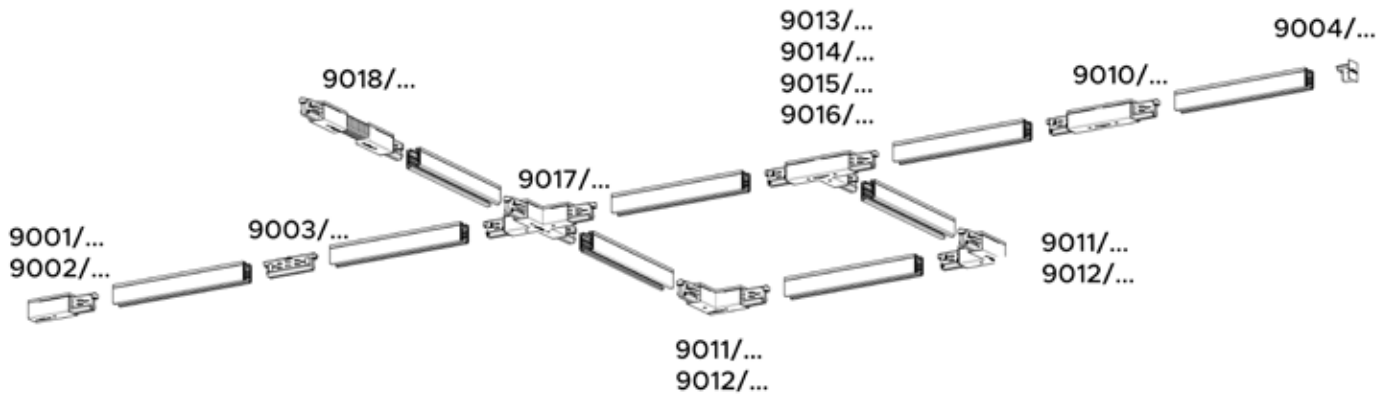

ONETRACK® features:

- universal system based on EUROSTANDARD PLUS® platform
- compatibility with all the existing systems
- easy to mount and change position
- circuits can be controlled individually
- modular solution, easy to extend/adapt
- suitable for department stores and shops
- recessed version also available

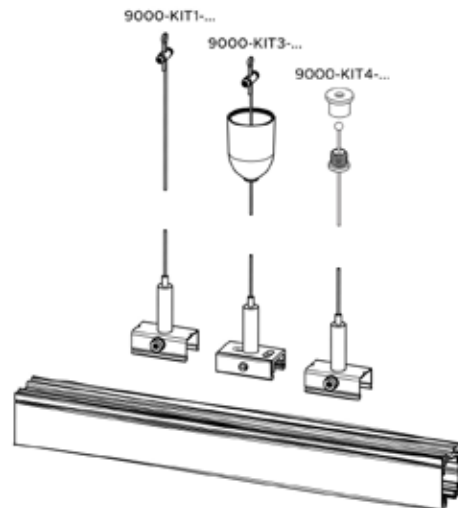
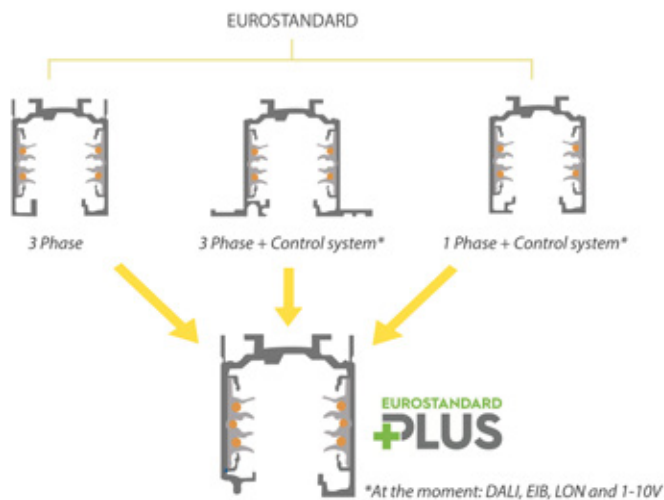

Mechanical keys:

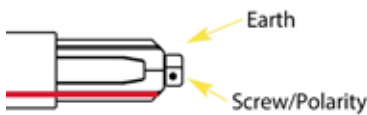

There is a mechanical key on the outline of the track to guarantee the right connection of the multiple pieces of the track. Also end-feeds and connection joints have a mechanical key (screw presence as per picture below) that must be taken into account in order to choose the right component. In the catalogue sketches of this articles the position of the key is highlighted with a red line

With the choice of colours and its minimal and elegant design, ONETRACK® system becomes almost invisible in lighting installation, leaving the focus on what is being illuminated. ONETRACK® tracks can be provided with a curved shape (minimum radius is 1.5m)

SURFACE TRACK

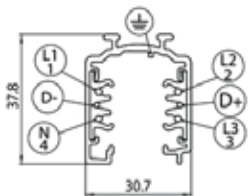

DESCRIPTION: Three-circuit surface track with two additional conductors intended to manage a general data signal (DALI, DMX, LON, EIB and others)

Body: extruded aluminium
Colour: white (W), RAL9010; black (B), RAL9005; light grey (G), RAL7035
Conductor: cooper, isolated in PVC profile

TECHNICAL DATA:

Rated current and voltage: L1/L2/L3/N/ground 16A/440V + D+/D- 2x1A/50V FELV AC (DALI)
Frequency: 50-60Hz
Phase/phases power: 3,6kVA/ 10,8kVA
Lengths: 1000, 2000, 3000, 4000 mm

RECESSED TRACK

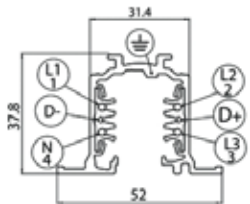

DESCRIPTION: Three-circuit recessed track with two additional conductors intended to manage a general data signal (DALI, DMX, LON, EIB and others)

Body: extruded aluminium
Colour: white (W), RAL 9010; black (B), RAL 9005; light grey (G), RAL7035
Conductor: cooper, isolated in PVC profile

TECHNICAL DATA:

Rated current and voltage: L1/L2/L3/N/ground 16A/440V + D+/D- 2x1A/50V FELV AC (DALI)
Frequency: 50-60Hz
Phase/phases power: 3,6kVA/ 10,8kVA
Lengths: 1000, 2000, 3000, 4000 mm

PRODUCT	COLOUR	PRODUCT	COLOUR	LENGTH, mm	WIDTH, mm	HEIGHT, mm	WEIGHT, kg
Track surface							
Track surface DALI 9000A-1/W-ST	White	Track surface DALI 9000A-1/B-ST	Black	1000	31	38	1,1
Track surface DALI 9000A-2/W-ST	White	Track surface DALI 9000A-2/B-ST	Black	2000	31	38	2,1
Track surface DALI 9000A-3/W-ST	White	Track surface DALI 9000A-3/B-ST	Black	3000	31	38	3,2
Track surface DALI 9000A-4/W-ST	White	Track surface DALI 9000A-4/B-ST	Black	4000	31	38	4,2
Track recessed							
Track recessed DALI 9000-1/W-R	White	Track recessed DALI 9000-1/B-R	Black	1000	52	38	1,1
Track recessed DALI 9000-2/W-R	White	Track recessed DALI 9000-2/B-R	Black	2000	52	38	2,2
Track recessed DALI 9000-3/W-R	White	Track recessed DALI 9000-3/B-R	Black	3000	52	38	3,3
Track recessed DALI 9000-4/W-R	White	Track recessed DALI 9000-4/B-R	Black	4000	52	38	4,4

Use of L- and T- accessories

Red line indicates polarity ridge

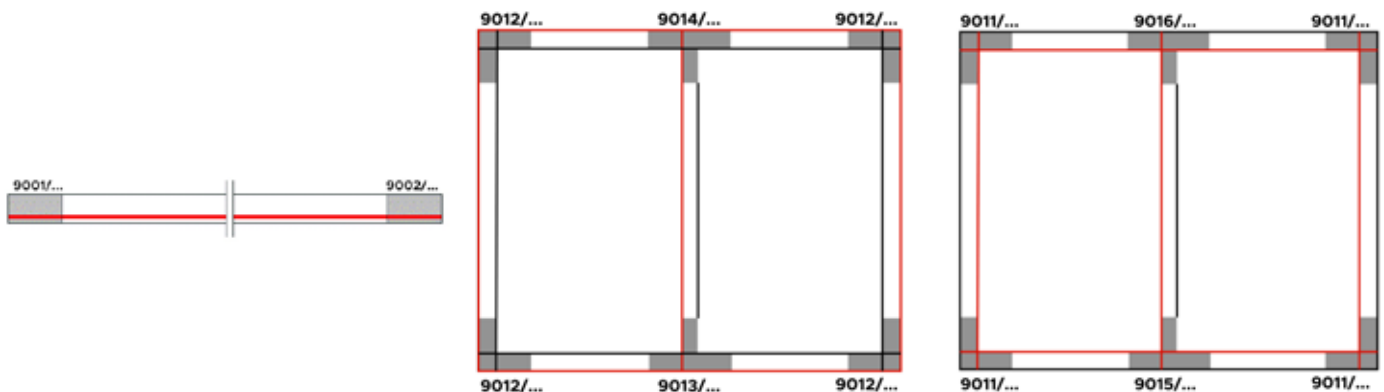

End-feed DALI 9001/... ; 9002/...: end-feed is used to feed track from the end and could have 2 different polarity ridges

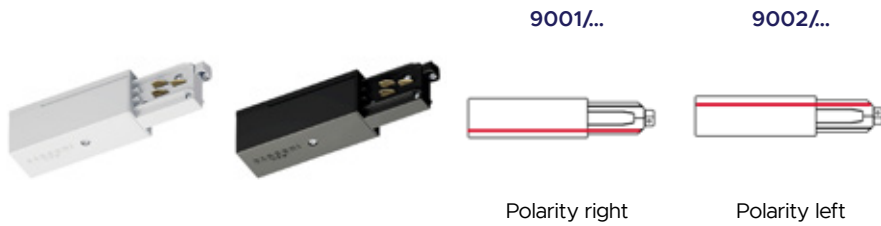

ARTICLE:

End-feed DALI 9001/W
End-feed DALI 9002/W
Body: polycarbonate
Colour: white (W), RAL9010;
black (B), RAL9005; light grey (G), RAL7035
Polarity: right, left
Screw terminal, 5/7x1.5-2.5mm²

L-feed DALI 9011/... ; 9012/...: L-feed is used to make track turn and could have 2 different polarity ridges

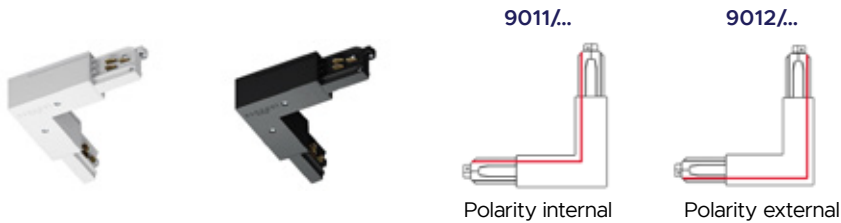

ARTICLE:

L-feed DALI 9011/W
L-feed DALI 9012/W
Body: polycarbonate
Colour: white (W), RAL9010;
black (B), RAL9005; light grey (G), RAL7035
Polarity: internal, external

T-feed DALI 9013/... ; 9014/... ; 9015/... ; 9016/...: T-feed is used to connect 3 branches and could have 4 different polarity ridges

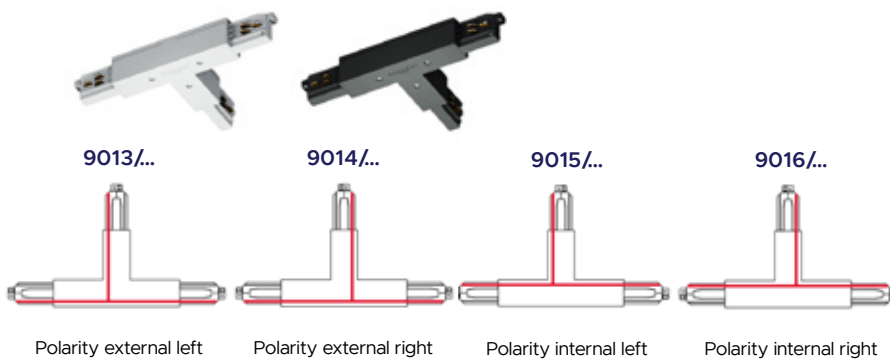

ARTICLE:

T-feed DALI 9013/W
T-feed DALI 9014/W
T-feed DALI 9015/W
T-feed DALI 9016/W
Body: polycarbonate
Colour: white (W), RAL9010; black (B),
RAL9005; light grey (G), RAL7035
Polarity: external left, external right, internal
left, internal right

Middle-feed DALI 9010/...: middle-feed is used to feed track from the chosen point and has 1 polarity ridge



ARTICLE:

Middle-feed DALI 9010/W
Body: polycarbonate
Colour: white (W), RAL9010;
black (B), RAL9005; light grey (G), RAL7035

Joining connector DALI 9003/...: joining connector allows connecting tracks together and has 1 polarity ridge;
Insulating connection DALI 9003/B-M

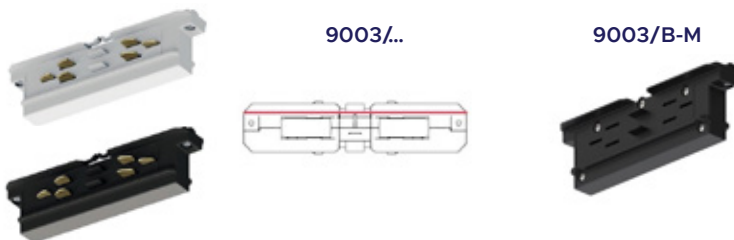

ARTICLE:

Joining connector DALI 9003/W
Colour: white (W), RAL9010;
black (B), RAL9005; light grey (G), RAL7035
Insulating connection DALI 9003/B-M
Colour: black (B), RAL9005
Body: polycarbonate

Flexible corner DALI 9018/...: flexible corner is used to obtain needed angle and has 1 polarity ridge



ARTICLE:

Flexible corner DALI 9018/W
Body: polycarbonate
Colour: white (W), RAL9010;
black (B), RAL9005; light grey (G), RAL7035

X-feed DALI 9017/...: X-feed allows to connect 4 branches and has 1 polarity ridge



ARTICLE:

X-feed DALI 9017/W
Body: polycarbonate
Colour: white (W), RAL9010;
black (B), RAL9005; light grey (G), RAL7035

End cap DALI 9004/... ; 9004-R/...: end cap is used to secure live ends of track

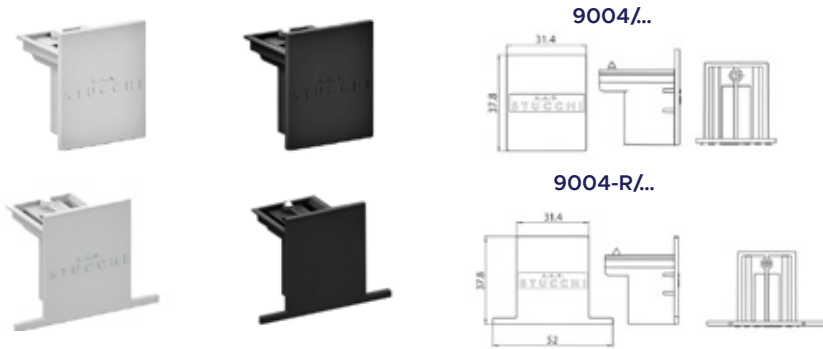

ARTICLE:

End cap DALI 9004/W
Colour: white (W), RAL9010;
 black (B), RAL9005; light grey (G), RAL7035
End cap recessed DALI 9004-R/W
Colour: white (W), RAL9010;
 black (B), RAL9005
Body: polycarbonate

Fix point surface DALI 9000/BPU-D-...: FIX point is a base for ceiling fixing of the DALI and non-DALI adapter without using the track



ARTICLE:

Fix point surface DALI 9000/BPU-D-W
Body: polycarbonate
Colour: white (W), RAL9010;
 black (B), RAL9005
Max. load: 50N

Cover strip for track recessed (S-9000/GP-...); Cover recessed DALI S-9001-R/6-... ; S-9010-R/6-... ; S-9011-R/6-... ; S-9013-R/6-... ; S-9017-R/6-...: recessed covers for strip, end, I-, L-, T-, X- feeds

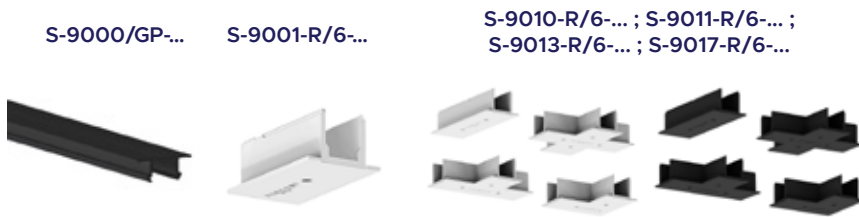

ARTICLE:

Cover strip for track recessed (S-9000/GP-W)
Cover recessed DALI S-9001-R/6-W
I-Cover recessed DALI S-9010-R/6-W
L-Cover recessed DALI S-9011-R/6-W
T-Cover recessed DALI S-9013-R/6-W
X-Cover recessed DALI S-9017-R/6-W
Body: polycarbonate
Colour: white (W), RAL9010;
 black (B), RAL9005

Suspension hook DALI S-9000/H-...: suspension hook for fixing on the track



ARTICLE:

Suspension hook DALI S-9000/H-W
Body: polyamide
 Zinc plated steel hook
Colour: white (W), RAL9010; black (B),
 RAL9005; light grey (G), RAL7035
Max. load: 50N

White plastic cup for steel cable diameter 1,5 mm S-9000/3-...: plastic cup for steel cable Ø 1.5mm



ARTICLE:

White plastic cup for steel cable diameter 1,5 mm S-9000/3-W
Body: polycarbonate
Colour: white (W), RAL9010;
 black (B), RAL9005

Cutting tool DALI S-9000/T: cutting tool for track conductors



ARTICLE:

Cutting tool DALI S-9000/T
Body: steel

TRACK ADAPTERS

ONETRACK® adapters phase selector allows to maintain the selected phase even though the adapter is attached/detached or re-attached to the track. This gives also the possibility to select the phase before the installation making it easier.

Available colours for adapters: white (W), RAL 9010; black (B), RAL 9005; light grey (G), RAL7035

Adapter asymmetric On/Off 9409-4/W: asymmetric 4 conductors track adapter (3 phase) with phase selector

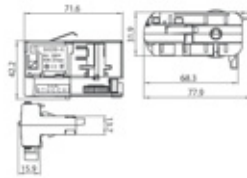

ARTICLE:

Adapter asymmetric On/Off 9409-4/W

Body: polycarbonate

Colour: white (W), RAL9010

Max. load: 50N

Adapter On/Off 9009-4/...: symmetric 4 conductors track adapter (3 phase + N) with phase selector

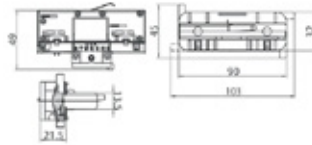

ARTICLE:

Adapter On/Off 9009-4/W

Body: polycarbonate

Colour: white (W), RAL9010;

black (B), RAL9005; light grey (G), RAL7035

Max. load: 100N

Adapter asymmetric DALI 9209-4/W: asymmetric 4 conductors track adapter (3 phase) with phase selector

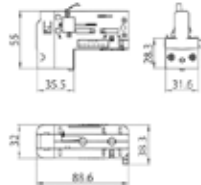

ARTICLE:

Adapter asymmetric DALI 9209-4/W

Body: polycarbonate

Colour: white (W), RAL9010

Max. load: 100N

Adapter DALI 9009/...: symmetric 6 conductors track adapter (3 phase + control system) with phase selector

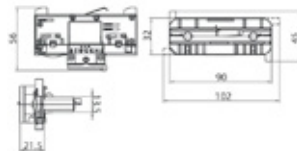

ARTICLE:

Adapter DALI 9009/W

Body: polycarbonate

Colour: white (W), RAL9010;

black (B), RAL9005; light grey (G), RAL7035

Max. load: 100N

Aluminium nipple for adapter S-9009/M10-SC; Aluminium nipple for adapter S-9009/M10; Aluminium nipple for adapter S-9209-BD/M10: nipple for fixing adapters

S-9009/M10-SC

S-9009/M10

S-9209-BD/M10



ARTICLE:

Aluminium nipple for adapter S-9009/M10-SC

Aluminium nipple for adapter S-9009/M10

Aluminium nipple for adapter S-9209-BD/M10

Body: aluminium

PRODUCT	DESCRIPTION	LENGTH, mm	WIDTH, mm	HEIGHT, mm	WEIGHT, kg
End-feed DALI 9001/W	End-feed, 440V/16A, polarity right, white PC body	95	31	37	0,1
End-feed DALI 9001/B	End-feed, 440V/16A, polarity right, black PC body	95	31	37	0,1
End-feed DALI 9002/W	End-feed, 440V/16A, polarity left, white PC body	95	31	37	0,1
End-feed DALI 9002/B	End-feed, 440V/16A, polarity left, black PC body	95	31	37	0,1
L-feed DALI 9011/W	L-feed, 440V/16A, polarity internal, white PC body	90	90	37	0,2
L-feed DALI 9011/B	L-feed, 440V/16A, polarity internal, black PC body	90	90	37	0,2
L-feed DALI 9012/W	L-feed, 440V/16A, polarity external, white PC body	90	90	37	0,2
L-feed DALI 9012/B	L-feed, 440V/16A, polarity external, black PC body	90	90	37	0,2
T-feed DALI 9013/W	T-feed, 440V/16A, polarity external left, white PC body	148	90	37	0,3
T-feed DALI 9013/B	T-feed, 440V/16A, polarity external left, black PC body	148	90	37	0,3
T-feed DALI 9014/W	T-feed, 440V/16A, polarity external right, white PC body	148	90	37	0,3
T-feed DALI 9014/B	T-feed, 440V/16A, polarity external right, black PC body	148	90	37	0,3
T-feed DALI 9015/W	T-feed, 440V/16A, polarity internal left, white PC body	148	90	37	0,3
T-feed DALI 9015/B	T-feed, 440V/16A, polarity internal left, black PC body	148	90	37	0,3
T-feed DALI 9016/W	T-feed, 440V/16A, polarity internal right, white PC body	148	90	37	0,3
T-feed DALI 9016/B	T-feed, 440V/16A, polarity internal right, black PC body	148	90	37	0,3
Middle-feed DALI 9010/W	Middle-feed, 440V/16A, universal polarity, white PC body	148	31	37	0,2
Middle-feed DALI 9010/B	Middle-feed, 440V/16A, universal polarity, black PC body	148	31	37	0,2
Joining connector DALI 9003/W	Joining connector, 440V/16A, universal polarity, white PC body	115	25	33	0,1
Joining connector DALI 9003/B	Joining connector, 440V/16A, universal polarity, black PC body	115	25	33	0,1
Insulating connection DALI 9003/B-M	Insulating connection, black PC body	115	25	33	0,1
Flexible corner DALI 9018/W	Flexible corner, 440V/16A, universal polarity, white PC body	265	31	37	0,2
Flexible corner DALI 9018/B	Flexible corner, 440V/16A, universal polarity, black PC body	265	31	37	0,2
X-feed DALI9017/W	X-feed, 440V/16A, universal polarity, white PC body	148	148	37	0,4
X-feed DALI 9017/B	X-feed, 440V/16A, universal polarity, black PC body	148	148	37	0,4
End cap DALI 9004/W	End cap for track with locking screw, white PC body	2	32	38	0,1
End cap DALI 9004/B	End cap for track with locking screw, black PC body	2	32	38	0,1
End cap recessed DALI 9004-R/W	End cap for recessed track with locking screw, white PC body	2	32	38	0,1
End cap recessed DALI 9004-R/B	End cap for recessed track with locking screw, black PC body	2	32	38	0,1
Fix point surface DALI 9000/BPU-D-W	4-conductors surface track fix point, 250V/10A white body, EUROSTANDARD PLUS® (L,N,PE,DA+,DA-)	118	118	38	0,1
Fix point surface DALI 9000/BPU-D-B	4-conductors surface track fix point, 250V/10A black body, EUROSTANDARD PLUS® (L,N,PE,DA+,DA-)	118	118	38	0,1
Cover strip for track recessed S-9000/GP-W	Cover strip for recessed track with locking screw, white PVC body	1000	26	10	0,1
Cover strip for track recessed S-9000/GP-B	Cover strip for recessed track with locking screw, black PVC body	1000	26	10	0,1
Cover recessed DALI S-9001-R/6-W	Recessed cover for end feed, white PC body	95	52	34	0,1
Cover recessed DALI S-9001-R/6-B	Recessed cover for end feed, black PC body	95	52	34	0,1
I-Cover recessed DALI S-9010-R/6-W	Recessed cover for middle feed, white PC body	148	52	34	0,1
I-Cover recessed DALI S-9010-R/6-B	Recessed cover for middle feed, black PC body	148	52	34	0,1
L-Cover recessed DALI S-9011-R/6-W	Recessed cover for L-feed, white PC body	100	100	34	0,1
L-Cover recessed DALI S-9011-R/6-B	Recessed cover for L-feed, black PC body	100	100	34	0,1
T-Cover recessed DALI S-9013-R/6-W	Recessed cover for T-feed, white PC body	148	100	34	0,1
T-Cover recessed DALI S-9013-R/6-B	Recessed cover for T-feed, black PC body	148	100	34	0,1
X-Cover recessed DALI S-9017-R/6-W	Recessed cover for X-feed, white PC body	148	148	34	0,1
X-Cover recessed DALI S-9017-R/6-B	Recessed cover for X-feed, black PC body	148	148	34	0,1
Suspension hook DALI S-9000/H-W	Suspension hook, white	28	26	48	0,1
Suspension hook DALI S-9000/H-B	Suspension hook, black	28	26	48	0,1
White plastic cup for steel cable diameter 1,5 mm S-9000/3-W	Plastic cup for steel cable Ø 1.5mm, white PC body	32	32	45	0,1
Black plastic cup for steel cable diameter 1,5 mm S-9000/3-B	Plastic cup for steel cable Ø 1.5mm, black PC body	32	32	45	0,1
Cutting tool DALI S-9000/T	Cutting tool for track conductors				0,1
Adapter asymmetric On/Off 9409-4/W	4-conductors adapter, 250V/10A, white, EUROSTANDARD PLUS® (L1,L2,L3,N,PE)	78	32	42	0,1
Adapter On/Off 9009-4/W	4-conductors adapter, 250V/10A, white, EUROSTANDARD PLUS® (L1,L2,L3,N,PE,DA+,DA-)	103	45	49	0,1
Adapter On/Off 9009-4/B	4-conductors adapter, 250V/10A, black, EUROSTANDARD PLUS® (L1,L2,L3,N,PE,DA+,DA-)	103	45	49	0,1
Adapter asymmetric DALI 9209-4/W	4-conductors adapter, 250V/10A, white, EUROSTANDARD PLUS® (L1,L2,L3,N,PE)	89	38	55	0,1
Adapter DALI 9009/W	6-conductors adapter, 250V/10A, white, EUROSTANDARD PLUS® (L1,L2,L3,N,PE,DA+,DA-)	102	45	56	0,1
Adapter DALI 9009/B	6-conductors adapter, 250V/10A, black, EUROSTANDARD PLUS® (L1,L2,L3,N,PE,DA+,DA-)	102	45	56	0,1
Adapter DALI GAC600-3(W)	6-conductors adapter, 250V/10A, white, EUROSTANDARD PLUS® (L1,L2,L3,N,PE,DA+,DA-)	104	32	53	0,1

PRODUCT	DESCRIPTION	LENGTH, mm	WIDTH, mm	HEIGHT, mm	WEIGHT, kg
Adapter DALI GAC600-2(B)	6-conductors adapter, 250V/10A, black, EUROSTANDARD PLUS® (L1,L2,L3,N,PE,DA+,DA-)	104	32	53	0,1
Mechanical adapter S-9000/M-W	Adapter, polycarbonate, white	55	32	28	0,1
Mechanical adapter S-9000/M-B	Adapter, polycarbonate, black	55	32	28	0,1
Aluminium nipple for adapter S-9009/M10-SC	Nipple for adapter	25	25	17	0,1
Aluminium nipple for adapter S-9009/M10	Nipple for adapter	25	25	23	0,1
Aluminium nipple for adapter S-9209-BD/M10	Nipple for adapter	27	24	24	0,1

THE SUSPENSION APPLICATIONS FOR TRACK SYSTEM



Complete wire suspension set

ARTICLE:

9000-KIT1-1.5	(L=1,5m)
9000-KIT1-3.0	(L=3,0m)
9000-KIT1-5.0	(L=5,0m)



Complete wire suspension set with plastic cup

ARTICLE:

9000-KIT3-1.5-W	(L=1,5m)
9000-KIT3-1.5-B	(L=1,5m)
9000-KIT3-3.0-W	(L=3,0m)
9000-KIT3-3.0-B	(L=3,0m)
9000-KIT3-5.0-W	(L=5,0m)
9000-KIT3-5.0-B	(L=5,0m)

Colour: white (W), RAL9010;
black (B), RAL9005



Complete wire suspension set with round ceiling attachment

ARTICLE:

9000-KIT4-1.5	(L=1,5m)
9000-KIT4-3.0	(L=3,0m)
9000-KIT4-5.0	(L=5,0m)

Load scheme

Maximum load for ceiling fixing clamp and wire suspension sets

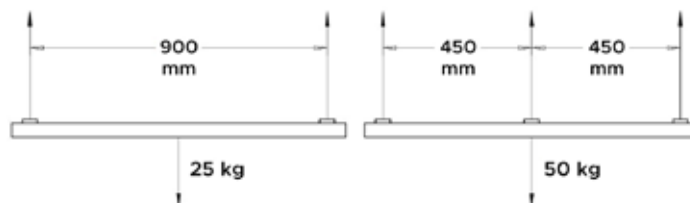

PRODUCT	DESCRIPTION	WEIGHT, kg
Suspension set DALI 9000-KIT1-1.5m	Wire suspension set 1,5m with screw gripper and clamp	0,1
Suspension set DALI 9000-KIT1-3.0m	Wire suspension set 3,0m with screw gripper and clamp	0,1
Suspension set DALI 9000-KIT1-5.0m	Wire suspension set 5,0m with screw gripper and clamp	0,1
Suspension set DALI 9000-KIT3-W-1.5m	Wire suspension set 1,5m with screw gripper, white plastic cap and clamp	0,1
Suspension set DALI 9000-KIT3-B-1.5m	Wire suspension set 1,5m with screw gripper, black plastic cap and clamp	0,1
Suspension set DALI 9000-KIT3-W-3.0m	Wire suspension set 3,0m with screw gripper, white plastic cap and clamp	0,1
Suspension set DALI 9000-KIT3-B-3.0m	Wire suspension set 3,0m with screw gripper, black plastic cap and clamp	0,1
Suspension set DALI 9000-KIT3-W-5.0m	Wire suspension set 5,0m with screw gripper, white plastic cap and clamp	0,1
Suspension set DALI 9000-KIT3-B-5.0m	Wire suspension set 5,0m with screw gripper, black plastic cap and clamp	0,1
Suspension set DALI 9000-KIT4-1.5m	Wire suspension set 1,5m with round head ceiling attachment and clamp	0,1
Suspension set DALI 9000-KIT4-3.0m	Wire suspension set 3m with round head ceiling attachment and clamp	0,1
Suspension set DALI 9000-KIT4-5.0m	Wire suspension set 5m with round head ceiling attachment and clamp	0,1

GLOBAL Trac Pro®

Track System and Parts

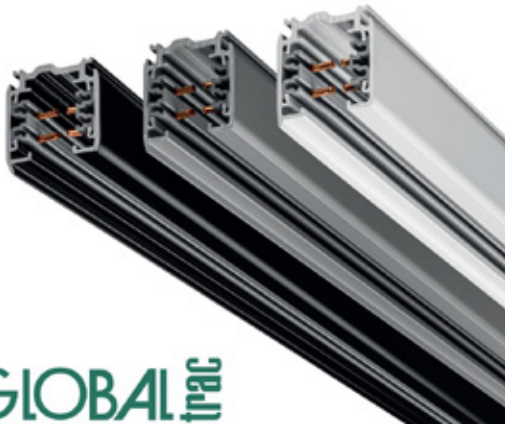
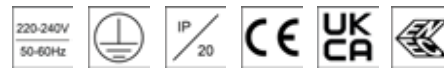

GLOBAL Trac Pro® is the most sold three-circuit lighting track system in the world. It is the quality choice of professionals and lighting manufacturers. Long experience and 100% quality assurance ensure problem-free operation.

The GLOBAL Trac Pro® 4 conductors track connection diagram:

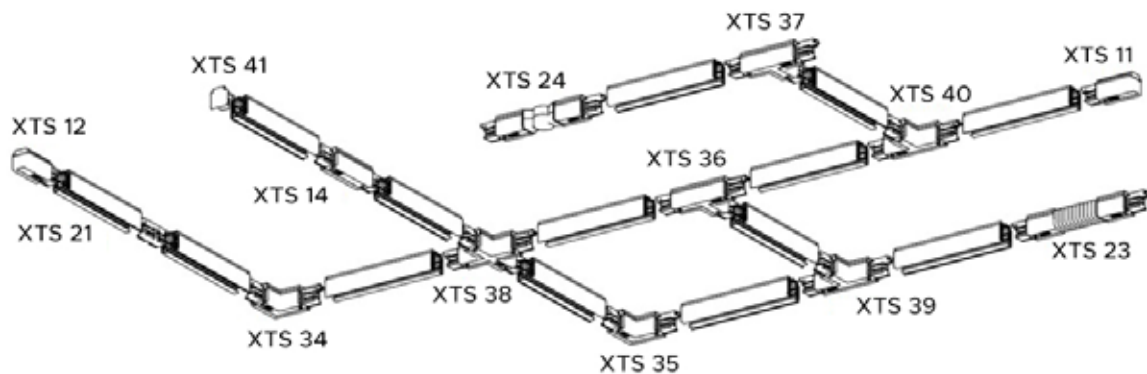

GLOBAL Trac Pro's® high load capacity and circuit-specific control option can be used in various spaces, including shops, department stores, public buildings, restaurants, airports and offices.

Easy to extend

The modular structure of the system makes it easy to extend and adapt to various needs. Modular dimensions help designers fit the system into the appropriate space and also make on-site mounting easier. Reliable connectors ensure fast and easy installation resulting in overall cost savings.

Load capacity

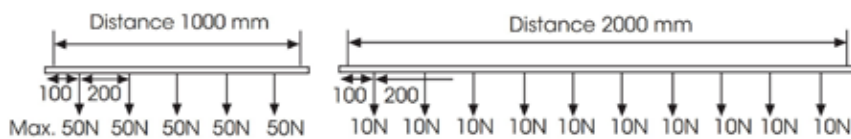

The Recommended fastening distance is 1000 mm

XTS SURFACE TRACK

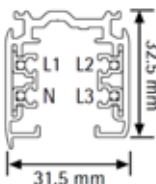

DESCRIPTION: **Three-circuit surface track**
Body: extruded aluminium
Colour: white (W), RAL9016; black (B), RAL9005; grey (G), AW202JR
Conductor: cooper, isolated in PVC profile

TECHNICAL DATA: **Rated current and voltage:** L1/L2/L3/neutral/ground 16 A/400 V. IP20
Frequency: 50-60Hz
Phase/phases power: 3,7kVA/ 11,0kVA
Lengths: 1000, 2000, 3000, 4000 mm

XTSF RECESSED TRACK

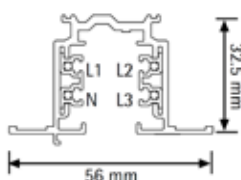

DESCRIPTION: **Three-circuit recessed track**
Body: extruded aluminium
Colour: white (W), RAL 9016; black (B), RAL 9005
Conductor: cooper, isolated in PVC profile

TECHNICAL DATA: **Rated current and voltage:** L1/L2/L3/neutral/ground 16 A/400 V. IP20
Frequency: 50-60Hz
Phase/phases power: 3,7kVA/ 11,0kVA
Lengths: 1000, 2000, 3000 mm

PRODUCT	COLOUR	PRODUCT	COLOUR	LENGTH, mm	WEIGHT, kg
Track surface					
Track surface On/Off (XTS 4100-2)(B)	Black	Track surface On/Off (XTS 4100-3)(W)	White	1000	1,1
Track surface On/Off (XTS 4200-2)(B)	Black	Track surface On/Off (XTS 4200-3)(W)	White	2000	2,0
Track surface On/Off (XTS 4300-2)(B)	Black	Track surface On/Off (XTS 4300-3)(W)	White	3000	2,8
Track surface On/Off (XTS 4400-2)(B)	Black	Track surface On/Off (XTS 4400-3)(W)	White	4000	3,6
Track recessed					
Track recessed On/Off (XTSF 4100-2)(B)	Black	Track recessed On/Off (XTSF 4100-3)(W)	White	1000	0,8
Track recessed On/Off (XTSF 4200-2)(B)	Black	Track recessed On/Off (XTSF 4200-3)(W)	White	2000	1,7
Track recessed On/Off (XTSF 4300-2)(B)	Black	Track recessed On/Off (XTSF 4300-3)(W)	White	3000	2,5

Use of L- and T- accessories

Red line indicates polarity ridge

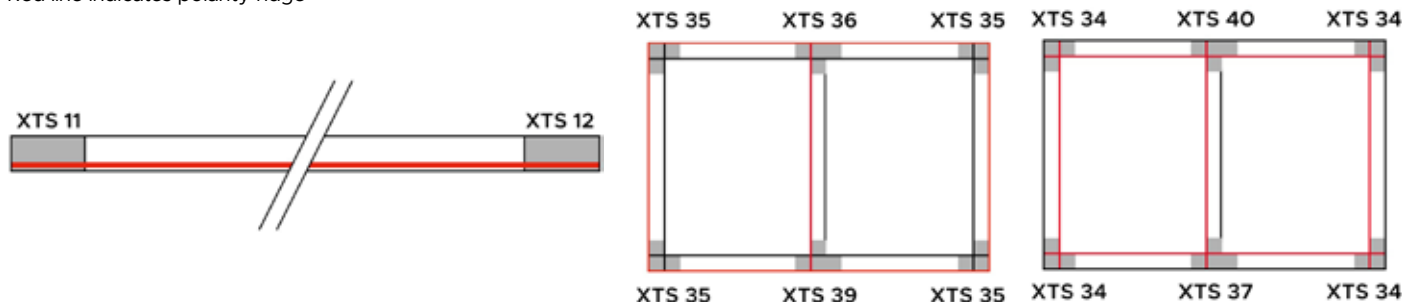

End-feed On/Off (XTS 11-...); (XTS 12-...): end-feed is used to feed track from the end and could have 2 different polarity ridges

XTS 11-...	XTS 12-...	XTS 11-...	XTS 12-...	ARTICLE: End-feed On/Off (XTS 11-3)(W) End-feed On/Off (XTS 12-3)(W) Body: polycarbonate Colour: white (W), RAL9016; black (B), RAL9005; grey (G), RAL7040 Polarity: right, left
		Polarity right	Polarity left	

L-feed On/Off (XTS 34-...); (XTS 35-...): L-feed is used to make track turn and could have 2 different polarity ridges

	XTS 34-...	XTS 35-...	ARTICLE: L-feed On/Off (XTS 34-3)(W) L-feed On/Off (XTS 35-3)(W) Body: polycarbonate Colour: white (W), RAL9016; black (B), RAL9005; grey (G), RAL7040 Polarity: internal, external
	Polarity internal	Polarity external	

T-feed On/Off (XTS 39-...); (XTS 36-...); (XTS 37-...); (XTS 40-...): T-feed is used to connect 3 branches and could have 4 different polarity ridges

	XTS 39-...	XTS 36-...	XTS 37-...	XTS 40-...	ARTICLE: T-feed On/Off (XTS 39-3)(W) T-feed On/Off (XTS 36-3)(W) T-feed On/Off (XTS 37-3)(W) T-feed On/Off (XTS 40-3)(W) Body: polycarbonate Colour: white (W), RAL9016; black (B), RAL9005; grey (G), RAL7040 Polarity: external left, external right, internal left, internal right
	Polarity external left	Polarity external right	Polarity internal left	Polarity internal right	

Middle-feed On/Off (XTS 14-...): middle-feed is used to feed track from the chosen point and has 1 polarity ridge

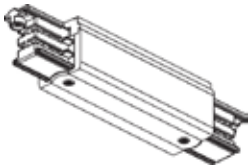

ARTICLE:

Middle-feed On/Off (XTS 14-3)(W)

Body: polycarbonate

Colour: white (W), RAL9016;
black (B), RAL9005; grey (G), RAL7040

Joining connector On/Off (XTS 21-...): joining connector allows connecting tracks together and has 1 polarity ridge

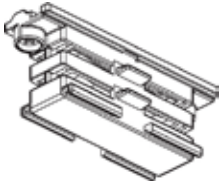

ARTICLE:

Joining connector On/Off (XTS 21-3)(W)

Body: polycarbonate

Colour: white (W), RAL9016;
black (B), RAL9005; grey (G), RAL7040

Flexible corner On/Off (FLEX XTS 23-...): flexible corner is used to obtain needed angle and has 1 polarity ridge

Adjustable corner On/Off (ANGLE XTS 24-...): adjustable corner is used to obtain needed angle and has 1 polarity ridge

FLEX XTS 23-...

ANGLE XTS 24-...

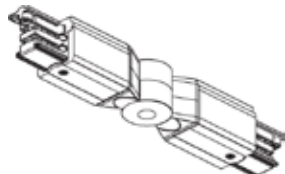
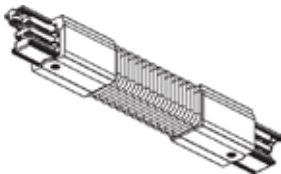

ARTICLE:

Flexible corner On/Off (FLEX XTS 23-3)(W)

Adjustable corner On/Off (ANGLE XTS 24-3)(W)

Body: polycarbonate

Colour: white (W), RAL9016;
black (B), RAL9005; grey (G), RAL7040

X-feed On/Off (XTS 38-...): X-feed allows to connect 4 branches and has 1 polarity ridge

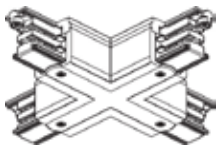

ARTICLE:

X-feed on/Off (XTS 38-3)(W)

Body: polycarbonate

Colour: white (W), RAL9016;
black (B), RAL9005; grey (G), RAL7040

End cap On/Off (XTS 41-...): end cap is used to secure live ends of track

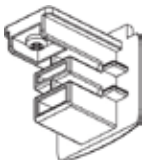

ARTICLE:

End cap On/Off (XTS 41-3)(W)

Body: polycarbonate

Colour: white (W), RAL9016;
black (B), RAL9005; grey (G), RAL7040

Fix point surface On/Off (GA70-...): 4-conductors surface track fix point

Fix point recessed On/Off (XTSA 71-...): Recessed track fix point

GA70-...

XTSA 71-...



ARTICLE:

Fix point surface On/Off (GA70-3)(W)

Fix point recessed On/Off (XTSA 71-3)(W)

Colour: white (W), RAL9016;
black (B), RAL9005; grey (G), RAL7040

Cover strip for track recessed (XTSP11-...); I-Cover recessed On/Off (XTSF 10-...); X-Cover recessed On/Off (XTSF 30-...): Recessed covers for strip, end, I-, X- feeds

XTSP11-...

XTSF 10-...

XTSF 30-...



ARTICLE:

Cover strip for track recessed (XTSP11-3)(W)

I-Cover recessed On/Off (XTSF 10-3)(W)

X-Cover recessed On/Off (XTSF 30-3)(W)

Colour: white (W), RAL9010;
black (B), RAL9005

Suspension cap On/Off (SKB30-...): ceiling clamp with cup



ARTICLE:

Suspension cap On/Off (SKB30-3)(W)

Colour: white (W), RAL9016;
black (B), RAL9005; grey (G), RAL7040

Max. load: 200N

Lighting track accessory On/Off (SKB 12-...): clamp for rod and wire

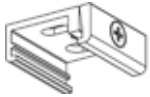

ARTICLE:

Lighting track accessory On/Off (SKB 12-3) (W)

Colour: white (W), RAL9016;
black (B), RAL9005; grey (G), RAL7040

Tool for contact bending On/Off (XTSV 12): bending tool for power wires



ARTICLE:

Tool for contact bending On/Off (XTSV 12)

Colour: blue

Hook base On/Off (GBA14-...): hook base for 2mm hook suspension



ARTICLE:

Hook base On/Off (GBA14-3)(W)

Colour: white (W), RAL9016;
black (B), RAL9005; grey (G), RAL7040

Max. load: 100N

Suspension hook On/Off (XTAK 11-1): hook 2mm



ARTICLE:

Suspension hook On/Off (XTAK 11-1)

Body: steel

Max. load: 100N

Adapter asymmetric On/Off (GA69-...): asymmetric 4 conductors track adapter (3-phase + N) with phase selector



ARTICLE:

Adapter asymmetric On/Off (GA69-3)(W)

Body: polycarbonate

Colour: white (W), RAL9016;
black (B), RAL9005; grey (G), RAL7040

Max. load: 50N

ADAPTER GA 69 WIRING OPTIONS:

- To be used with stranded 0.5 ... 1.0mm² wire
- Slot Connection. The conductors are pressed into the connections by the connector lid or by the cable mounting tool
- Optional cable grip CG 69

Cable Holder CG69 for adapter GA69: strain relief for adapter GA69



ARTICLE:

Cable Holder CG69 for adapter GA69

Aluminium nipple for adapter (XTS 58/8-9): aluminium nipple for adapter GA69



ARTICLE:

Aluminium nipple for adapter (XTS 58/8-9)

Body: aluminum

PRODUCT	DESCRIPTION	LENGTH, mm	WIDTH, mm	HEIGHT, mm	WEIGHT, kg
End-feed On/Off (XTS 11-2)(B)	End-feed, polarity right, black PC body	105	32	33	0,1
End-feed On/Off (XTS 11-3)(W)	End-feed, polarity right, white PC body	105	32	33	0,1
End-feed On/Off (XTS 12-2)(B)	End-feed, polarity left, black PC body	105	32	33	0,1
End-feed On/Off (XTS 12-3)(W)	End-feed, polarity left, white PC body	105	32	33	0,1
L-feed On/Off (XTS 34-2)(B)	L-feed, polarity internal, black PC body	99	99	33	0,1
L-feed On/Off (XTS 34-3)(W)	L-feed, polarity internal, white PC body	99	99	33	0,1
L-feed On/Off (XTS 35-2)(B)	L-feed, polarity external, black PC body	99	99	33	0,1
L-feed On/Off (XTS 35-3)(W)	L-feed, polarity external, white PC body	99	99	33	0,1
T-feed On/Off (XTS 39-2)(B)	T-feed, polarity external left, black PC body	166	99	33	0,1
T-feed On/Off (XTS 39-3)(W)	T-feed, polarity external left, white PC body	166	99	33	0,1
T-feed On/Off (XTS 36-2)(B)	T-feed, polarity external right, black PC body	166	99	33	0,1
T-feed On/Off (XTS 36-3)(W)	T-feed, polarity external right, white PC body	166	99	33	0,1
T-feed On/Off (XTS 37-2)(B)	T-feed, polarity internal left, black PC body	166	99	33	0,1
T-feed On/Off (XTS 37-3)(W)	T-feed, polarity internal left, white PC body	166	99	33	0,1
T-feed On/Off (XTS 40-2)(B)	T-feed, polarity internal right, black PC body	166	99	33	0,1
T-feed On/Off (XTS 40-3)(W)	T-feed, polarity internal right, white PC body	166	99	33	0,1
Middle-feed On/Off (XTS 14-2)(B)	Middle-feed, black PC body	166	32	33	0,1
Middle-feed On/Off (XTS 14-3)(W)	Middle-feed, white PC body	166	32	33	0,1
Jointing connector On/Off (XTS 21-2)(B)	Jointing connector, black PC body	68	20	26	0,1
Jointing connector On/Off (XTS 21-3)(W)	Jointing connector, white PC body	68	20	26	0,1
Flexible corner On/Off (FLEX XTS 23-2)(B)	Flexible corner, universal polarity, black PC body	248	32	33	0,1
Flexible corner On/Off (FLEX XTS 23-3)(W)	Flexible corner, universal polarity, white PC body	248	32	33	0,1
Adjustable corner On/Off (ANGLE XTS 24-2)(B)	Adjustable corner, universal polarity, black PC body	226	32	33	0,1
Adjustable corner On/Off (ANGLE XTS 24-3)(W)	Adjustable corner, universal polarity, white PC body	226	32	33	0,1
X-feed On/Off (XTS 38-2)(B)	X-feed, universal polarity, black PC body	166	166	33	0,2
X-feed on/Off (XTS 38-3)(W)	X-feed, universal polarity, white PC body	166	166	33	0,2
End cap On/Off (XTS 41-2)(B)	End cap for track with locking screw, black PC body	31	32	33	0,1
End cap On/Off (XTS 41-3)(W)	End cap for track with locking screw, white PC body	31	32	33	0,1
Fix point surface On/Off (GA70-2)(B)	4-conductors surface track fix point, 250V/10A black body, eurostandard plus (L1,L2,L3,N,PE)	100	100	32	0,1
Fix point surface On/Off (GA70-3)(W)	4-conductors surface track fix point, 250V/10A white body, eurostandard plus (L1,L2,L3,N,PE)	100	100	32	0,1
Fix point recessed On/Off (XTSA 71-2)(B)	Recessed track fix point, black body	130	130	60	0,1
Fix point recessed On/Off (XTSA 71-3)(W)	Recessed track fix point, white body	130	130	60	0,1
Cover strip for track recessed (XTSP11-2)(B)	Cover strip for recessed track, black body	3000			0,1
Cover strip for track recessed (XTSP11-3)(W)	Cover strip for recessed track, white body	3000			0,1
I-Cover recessed On/Off (XTSF 10-2)(B)	Outlet/cover plate for feeds	109	56	4	0,1
I-Cover recessed On/Off (XTSF 10-3)(W)	Outlet/cover plate for feeds	109	56	4	0,1
X-Cover recessed On/Off (XTSF 30-2)(B)	Cover plate: XTS34-40	109	109	4	0,1
X-Cover recessed On/Off (XTSF 30-3)(W)	Cover plate: XTS34-40	109	109	4	0,1
Suspension cap On/Off (SKB30-2)(B)	Ceiling clamp with cup, black				0,1
Suspension cap On/Off (SKB30-3)(W)	Ceiling clamp with cup, white				0,1
Lighting track accessory On/Off (SKB 10-2)(B)	Track clamp, black	30	30	12	0,1
Lighting track accessory On/Off (SKB 10-3)(W)	Track clamp, white	30	30	12	0,1
Lighting track accessory On/Off (SKB 12-2)(B)	Clamp for Rod and Wire, black	30	30	12	0,1
Lighting track accessory On/Off (SKB 12-3)(W)	Clamp for Rod and Wire, white	30	30	12	0,1
Tool for contact bending On/Off (XTSV 12)	Bending tool, blue	135	15	23	0,1
Hook base On/Off (GBA14-2)(B)	Hook base, black	20	20	5	0,1
Hook base On/Off (GBA14-3)(W)	Hook base, white	20	20	5	0,1
Suspension hook On/Off (XTAK 11-1)	Hook, steel				0,1
Cable Holder CG69 for adapter GA69	Cable holder				0,1
Adapter asymmetric On/Off (GA69-2)(B)	4-conductors adapter, 250V/6A, black, eurostandard plus (L1,L2,L3,N,PE)	70	32	40	0,1
Adapter asymmetric On/Off (GA69-3)(W)	4-conductors adapter, 250V/6A, white, eurostandard plus (L1,L2,L3,N,PE)	70	32	40	0,1
Aluminium nipple for adapter (XTS 58/8-9)	Aluminium nipple for adapter	7	7	8	0,1

THE SUSPENSION APPLICATIONS FOR TRACK SYSTEM



Complete wire suspension set

ARTICLE:

1.5m KIT1 W	(L=1,5m)
1.5m KIT1 B	(L=1,5m)
3.0m KIT1 W	(L=3,0m)
3.0m KIT1 B	(L=3,0m)
5.0m KIT1 W	(L=5,0m)
5.0m KIT1 B	(L=5,0m)

Colour: white (W), RAL9010; black (B), RAL9005



Complete wire suspension set with plastic cup

ARTICLE:

1.5m KIT3-W	(L=1,5m)
1.5m KIT3-B	(L=1,5m)
3.0m KIT3-W	(L=3,0m)
3.0m KIT3-B	(L=3,0m)
5.0m KIT3-W	(L=5,0m)
5.0m KIT3-B	(L=5,0m)

Colour: white (W), RAL9010; black (B), RAL9005



Complete wire suspension set with round ceiling attachment

ARTICLE:

1.5m KIT4 W	(L=1,5m)
1.5m KIT4 B	(L=1,5m)
3.0m KIT4 W	(L=3,0m)
3.0m KIT4 B	(L=3,0m)
5.0m KIT4 W	(L=5,0m)
5.0m KIT4 B	(L=5,0m)

Colour: white (W), RAL9010; black (B), RAL9005

Load scheme

Maximum load for ceiling fixing clamp and wire suspension sets

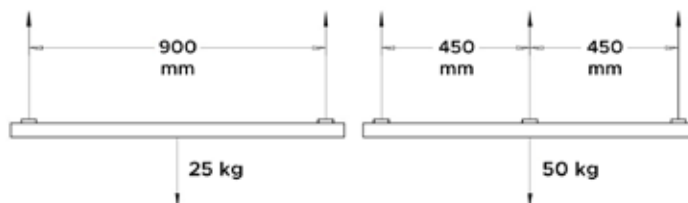

PRODUCT	DESCRIPTION	WEIGHT, kg
Suspension set ON/OFF KIT1 W-1.5m	Wire suspension set 1,5m with screw gripper and white clamp	0,1
Suspension set ON/OFF KIT1 B-1.5m	Wire suspension set 1,5m with screw gripper and black clamp	0,1
Suspension set ON/OFF KIT1 W-3.0m	Wire suspension set 3,0m with screw gripper and white clamp	0,1
Suspension set ON/OFF KIT1 B-3.0m	Wire suspension set 3,0m with screw gripper and black clamp	0,1
Suspension set ON/OFF KIT1 W-5.0m	Wire suspension set 5,0m with screw gripper and white clamp	0,1
Suspension set ON/OFF KIT1 B-5.0m	Wire suspension set 5,0m with screw gripper and black clamp	0,1
Suspension set ON/OFF KIT3-W-1.5m	Wire suspension set 1,5m with screw gripper, white plastic cap and clamp	0,1
Suspension set ON/OFF KIT3-B-1.5m	Wire suspension set 1,5m with screw gripper, black plastic cap and clamp	0,1
Suspension set ON/OFF KIT3-W-3.0m	Wire suspension set 3,0m with screw gripper, white plastic cap and clamp	0,1
Suspension set ON/OFF KIT3-B-3.0m	Wire suspension set 3,0m with screw gripper, black plastic cap and clamp	0,1
Suspension set ON/OFF KIT3-W-5.0m	Wire suspension set 5,0m with screw gripper, white plastic cap and clamp	0,1
Suspension set ON/OFF KIT3-B-5.0m	Wire suspension set 5,0m with screw gripper, black plastic cap and clamp	0,1
Suspension set ON/OFF KIT4 W-1.5m	Wire suspension set 1,5m with white round head ceiling attachment and clamp	0,1
Suspension set ON/OFF KIT4 B-1.5m	Wire suspension set 1,5m with black round head ceiling attachment and clamp	0,1
Suspension set ON/OFF KIT4 W-3.0m	Wire suspension set 3,0m with white round head ceiling attachment and clamp	0,1
Suspension set ON/OFF KIT4 B-3.0m	Wire suspension set 3,0m with black round head ceiling attachment and clamp	0,1
Suspension set ON/OFF KIT4 W-5.0m	Wire suspension set 5,0m with white round head ceiling attachment and clamp	0,1
Suspension set ON/OFF KIT4 B-5.0m	Wire suspension set 5,0m with black round head ceiling attachment and clamp	0,1

DOWNLIGHTS



AIN LED

Downlights



DESCRIPTION: Recessed mounted LED downlight
Light distribution type: direct
Optical system: lens, 40°, tilting angle ±30°
Housing: polycarbonate
Colour: white, RAL9016

GENERAL DATA: Mains voltage: 220-240V, 50-60Hz
LED lifetime, h: 30000/L70B50
SDCM: 3
Protection class IEC: II
Ingress protection code: IP44
Mechanical impact resistance: IK05
Operating temperature range, °C: ta -20...+40

INSTALLATION: In ceilings with cut-out openings (mounting brackets included). Push-in terminal, 2x2x2.5mm²

ENVIRONMENT: Indoor

APPLICATION: Office, education, hotel, corridor, bathroom, showroom, exhibition, public place

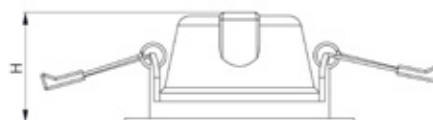
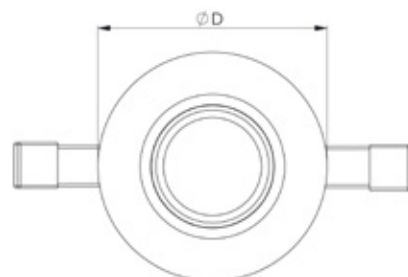

PRODUCT	DIAMETER, mm	HEIGHT, mm	CUT-OUT, mm	LUMINAIRE OUTPUT*, lm	SYSTEM POWER*, W	SYSTEM EFFICACY*, lm/W	CRI	CCT*, K	WEIGHT, kg
Ain LED1x550 D944 T830	85	44	68	550	6,5	85	80+	3000	0,2
Ain LED1x550 D944 T830 TDIM	85	44	68	550	6,5	85	80+	3000	0,2

*Tolerance range for optical and electrical data: ±10%. Values apply to an ambient temperature of 25°C. NORTHCLIFFE LIGHTING is constantly developing and improving its products. The right is reserved to change any product specifications without prior notification

OPTIONS AVAILABLE ON REQUEST:

CONTROL GEAR

TDIM

STANDARD

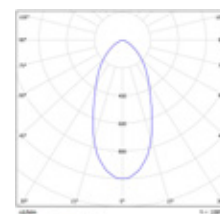

AIN A LED

Downlights



DESCRIPTION: Recessed mounted LED downlight
Light distribution type: direct
Optical system: lens, 60°
Housing: stamped steel
Colour: white, RAL9003; black, RAL9005
 Fire rated 30, 60 and 90 min

GENERAL DATA: **Mains voltage:** 220-240V, 50-60Hz
LED lifetime, h: 40000/L70B50
SDCM: 5
Protection class IEC: I
Ingress protection code: IP65
Mechanical impact resistance: IK04
Operating temperature range, °C: ta -10...+35

INSTALLATION: In ceilings with cut-out openings (mounting brackets included). Push-in terminal, 3x2x2.5mm²

ENVIRONMENT: Indoor

APPLICATION: Office, education, hotel, corridor, bathroom, showroom, exhibition, public place

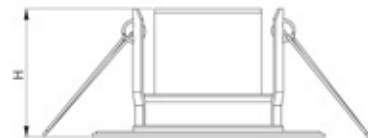
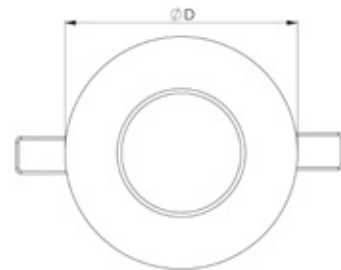

PRODUCT	DIAMETER, mm	HEIGHT, mm	CUT-OUT, mm	LUMINAIRE OUTPUT*, lm	SYSTEM POWER*, W	SYSTEM EFFICACY*, lm/W	CRI	CCT*, K	WEIGHT, kg
Ain A LED1x450 G679 T840 TDIM	80	50	60	500	5,0	100	80+	4000	0,2

*Tolerance range for optical and electrical data: ±10%. Values apply to an ambient temperature of 25°C. NORTHCLIFFE LIGHTING is constantly developing and improving its products. The right is reserved to change any product specifications without prior notification

OPTIONS AVAILABLE ON REQUEST:

LED	COLOUR
T830	RAL9005
T840	

STANDARD

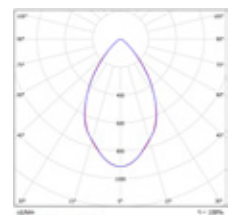

AIN B LED

Downlights

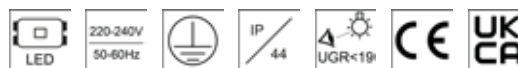

DESCRIPTION: Recessed mounted LED downlight
Light distribution type: direct
Optical system: lens, 60°, tilt adjustable
Housing: stamped steel
Colour: white, RAL9003; black, RAL9005
 Fire rated 30, 60 and 90 min

GENERAL DATA: Mains voltage: 220-240V, 50-60Hz
 LED lifetime, h: 40000/L70B50
 SDCM: 5
 Protection class IEC: I
 Ingress protection code: IP44
 Mechanical impact resistance: IK04
 Operating temperature range, °C: ta -10..+35

INSTALLATION: In ceilings with cut-out openings (mounting brackets included). Push-in terminal, 3x2x2.5mm²

ENVIRONMENT: Indoor

APPLICATION: Office, education, hotel, corridor, bathroom, showroom, exhibition, public place

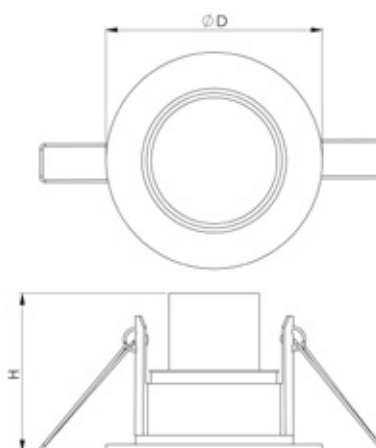

PRODUCT	DIAMETER, mm	HEIGHT, mm	CUT-OUT, mm	LUMINAIRE OUTPUT*, lm	SYSTEM POWER*, W	SYSTEM EFFICACY*, lm/W	CRI	CCT*, K	WEIGHT, kg
Ain B LED1x450 G680 T840 TDIM	82	63	65	500	5,0	100	80+	4000	0,2

*Tolerance range for optical and electrical data: ±10%. Values apply to an ambient temperature of 25°C. NORTHCLIFFE LIGHTING is constantly developing and improving its products. The right is reserved to change any product specifications without prior notification

OPTIONS AVAILABLE ON REQUEST:

LED	COLOUR
T830	RAL9005
T840	

STANDARD

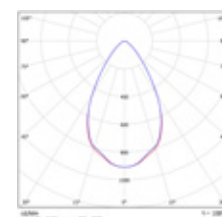

AIN C LED

Downlights

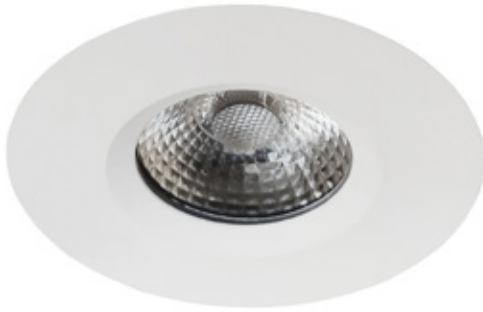

- DESCRIPTION:** Recessed mounted LED downlight
Light distribution type: direct
Optical system: lens, 40°
Housing: die cast aluminium
Colour: white, RAL9003
 Fire rated 30, 60 and 90 min
-
- GENERAL DATA:** **Mains voltage:** 220-240V, 50-60Hz
LED lifetime, h: 40000/L70B50
SDCM: 5
Protection class IEC: II
Ingress protection code: IP65
Mechanical impact resistance: IK04
Operating temperature range, °C: ta -10...+40
-
- INSTALLATION:** In ceilings with cut-out openings (mounting brackets included). Push-in terminal, 2x1x1mm²
-
- ENVIRONMENT:** Indoor
-
- APPLICATION:** Office, education, hotel, corridor, bathroom, showroom, exhibition, public place

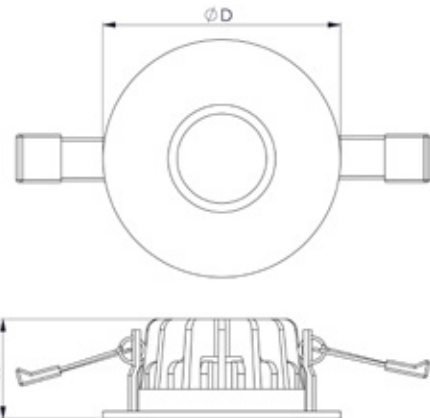

PRODUCT	DIAMETER, mm	HEIGHT, mm	CUT-OUT, mm	LUMINAIRE OUTPUT*, lm	SYSTEM POWER*, W	SYSTEM EFFICACY*, lm/W	CRI	CCT*, K	WEIGHT, kg
Ain C LED1x700 G681 T840	84	53	69	850	8,5	100	80+	4000	0,3

*Tolerance range for optical and electrical data: ±10%. Values apply to an ambient temperature of 25°C. NORTHCLIFFE LIGHTING is constantly developing and improving its products. The right is reserved to change any product specifications without prior notification

OPTIONS AVAILABLE ON REQUEST:

LED	CONTROL GEAR	COLOUR
T830	DALI	RAL
T840	TDIM	

STANDARD

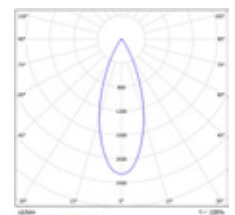

AIN D LED

Downlights

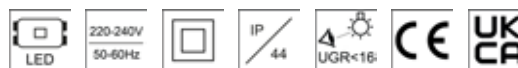

- DESCRIPTION:** Recessed mounted LED downlight
Light distribution type: direct
Optical system: lens, 40°, tilt adjustable
Housing: die cast aluminium
Colour: white, RAL9003
 Fire rated 30, 60 and 90 min
-
- GENERAL DATA:** **Mains voltage:** 220-240V, 50-60Hz
LED lifetime, h: 40000/L70B50
SDCM: 5
Protection class IEC: II
Ingress protection code: IP44
Mechanical impact resistance: IK04
Operating temperature range, °C: ta -10...+40
-
- INSTALLATION:** In ceilings with cut-out openings (mounting brackets included). Push-in terminal, 2x1x1mm²
-
- ENVIRONMENT:** Indoor
-
- APPLICATION:** Office, education, hotel, corridor, bathroom, showroom, exhibition, public place

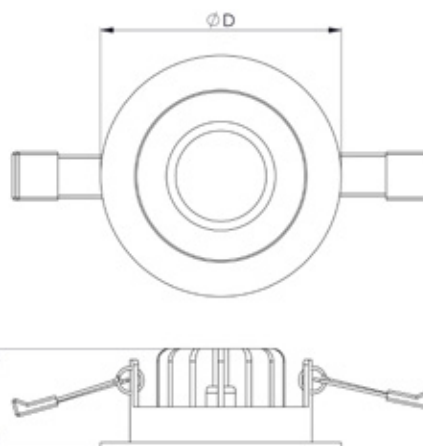

PRODUCT	DIAMETER, mm	HEIGHT, mm	CUT-OUT, mm	LUMINAIRE OUTPUT*, lm	SYSTEM POWER*, W	SYSTEM EFFICACY*, lm/W	CRI	CCT*, K	WEIGHT, kg
Ain D LED1x700 G682 T840	96	56	80	850	8,5	100	80+	4000	0,4

*Tolerance range for optical and electrical data: ±10%. Values apply to an ambient temperature of 25°C. NORTHCLIFFE LIGHTING is constantly developing and improving its products. The right is reserved to change any product specifications without prior notification

OPTIONS AVAILABLE ON REQUEST:

LED	CONTROL GEAR	COLOUR
T830	DALI	RAL
T840	TDIM	

STANDARD

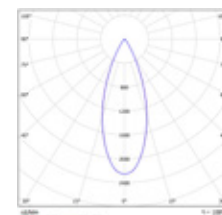

COXA Q LED

Downlights

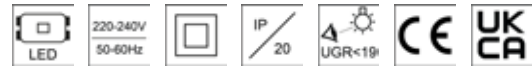

DESCRIPTION: Recessed mounted LED downlight
Light distribution type: direct
Optical system: lenses, mirror metallic reflector
Housing: aluminium
Colour: white, RAL9016

GENERAL DATA: **Mains voltage:** 220-240V, 50-60Hz
LED lifetime, h: 50000/L80B10
SDCM: 3
Protection class IEC: II
Ingress protection code: IP20
Mechanical impact resistance: IK02
Operating temperature range, °C: ta -10...+40

INSTALLATION: In ceilings with cut-out openings (mounting brackets included). Installation in metal ceiling grid. Cable, 0.15m, 2x0.75mm²

ENVIRONMENT: Indoor

APPLICATION: Office, education, hotel, corridor, showroom, exhibition, public place

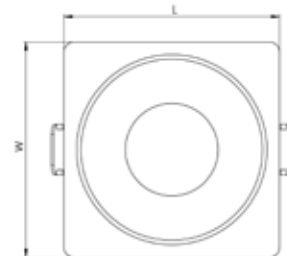

PRODUCT	LENGTH, mm	WIDTH, mm	HEIGHT, mm	CUT-OUT, mm	LUMINAIRE OUTPUT*, lm	SYSTEM POWER*, W	SYSTEM EFFICACY*, lm/W	CRI	CCT*, K	WEIGHT, kg
Coxa Q LED1x1200 J834 T840 L55 MGC	85	85	64	d75	1187	9,7	122	80+	4000	0,2
Coxa Q LED1x1200 J834 T840 L36 MGC	85	85	64	d75	1186	9,7	122	80+	4000	0,2

*Tolerance range for optical and electrical data: ±10%. Values apply to an ambient temperature of 25°C. NORTHCLIFFE LIGHTING is constantly developing and improving its products. The right is reserved to change any product specifications without prior notification

OPTIONS AVAILABLE ON REQUEST:

LED	REFLECTOR AND OPTICS	CONTROL GEAR
T830	L36	DALI
T840	MGC	
	MMC	
	WMC	
	BMC	

MGC L55

MGC L36

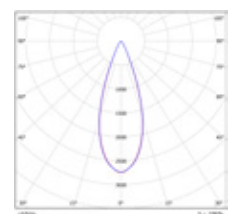
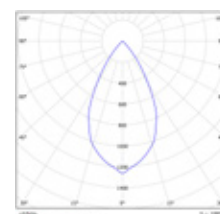

ALVA LED

Downlights

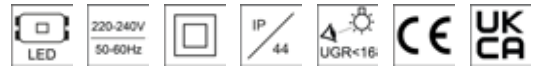

- DESCRIPTION:** Recessed mounted LED downlight
Light distribution type: direct
Optical system: lens, 40°
Housing: die cast aluminium
Colour: white, RAL9003
-
- GENERAL DATA:** **Mains voltage:** 220-240V, 50-60Hz
LED lifetime, h: 40000/L70B50
SDCM: 5
Protection class IEC: II
Ingress protection code: IP44
Mechanical impact resistance: IK04
Operating temperature range, °C: ta -10..+40
-
- INSTALLATION:** In ceilings with cut-out openings (mounting brackets included). Push-in terminal, 2x1x1mm²
-
- ENVIRONMENT:** Indoor
-
- APPLICATION:** Office, education, hotel, corridor, bathroom, showroom, exhibition, public place

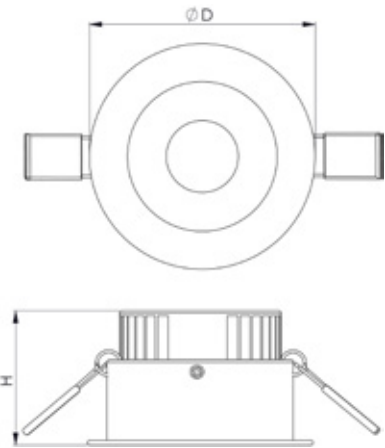

PRODUCT	DIAMETER, mm	HEIGHT, mm	CUT-OUT, mm	LUMINAIRE OUTPUT*, lm	SYSTEM POWER*, W	SYSTEM EFFICACY*, lm/W	CRI	CCT*, K	WEIGHT, kg
Alva LED1x700 G683 T840	96	56	80	850	8,5	100	80+	4000	0,4

*Tolerance range for optical and electrical data: ±10%. Values apply to an ambient temperature of 25°C. NORTHCLIFFE LIGHTING is constantly developing and improving its products. The right is reserved to change any product specifications without prior notification

OPTIONS AVAILABLE ON REQUEST:

LED	CONTROL GEAR	COLOUR
T830	DALI	RAL
T840	TDIM	

STANDARD

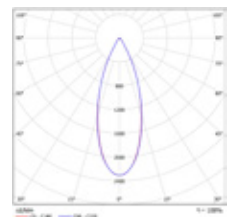

AURIGA LED

Downlights

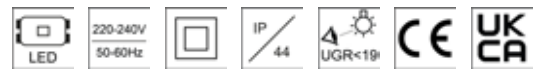

DESCRIPTION: **Recessed mounted LED downlight**
Light distribution type: direct
Optical system: faceted aluminium reflector, 60°, low glare, clear glass diffuser / opal PMMA diffuser / translucent micro-prismatic PMMA diffuser
Housing: aluminium
Colour: white, RAL9016

GENERAL DATA: **Mains voltage:** 220-240V, 0/50-60Hz
LED lifetime, h: 60000/L80B10
SDCM: 3
Protection class IEC: II
Ingress protection code: IP44
Mechanical impact resistance: IK04
Operating temperature range, °C: ta 0..+35

INSTALLATION: In ceilings with cut-out openings (mounting brackets included). Push-in terminal, 2x1x1.5mm²

ENVIRONMENT: Indoor

APPLICATION: Office, education, hotel, corridor, bathroom, retail, showroom, exhibition, public place

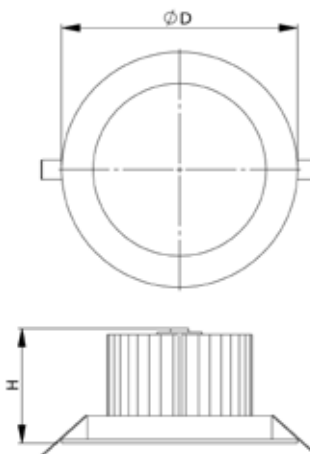

PRODUCT	DIAMETER, mm	HEIGHT, mm	CUT-OUT, mm	LUMINAIRE OUTPUT*, lm	SYSTEM POWER*, W	SYSTEM EFFICACY*, lm/W	CRI	CCT*, K	WEIGHT, kg
Auriga LED1x1900 D329 T840 CLR	195	100	165	1879	13,5	139	80+	4000	0,8
Auriga LED1x2500 D330 T840 CLR	195	100	165	2553	18,7	137	80+	4000	0,8
Auriga LED1x3300 D331 T840 CLR	195	100	165	3437	26,5	130	80+	4000	0,8

*Tolerance range for optical and electrical data: ±10%. Values apply to an ambient temperature of 25°C. NORTHCLIFFE LIGHTING is constantly developing and improving its products. The right is reserved to change any product specifications without prior notification

AVAILABLE ACCESSORIES:



Product: Auriga LED diffuser 145mm OP LT80
Description: Opal diffuser with high light transmittance



Product: Auriga LED diffuser 145mm MPRZ LT92
Description: Translucent micro-prismatic diffuser with high light transmittance

OPTIONS AVAILABLE ON REQUEST:

LED	REFLECTOR AND OPTICS	CONTROL GEAR	EMERGENCY	CONNECTION	COLOUR
T830	OP LT80	DALI	EM3	WIE3-0.5m	RAL
T840	MPRZ LT92		EM3B	WIE5D-0.5m	
T930	OP TP(a)		EM3A	QBX2-0.1m	
T940			EM3D	Europlug-1.5m	
T927 NATURAL				Europlug-3.0m	
T930 NATURAL					
T940 NATURAL					

CLR

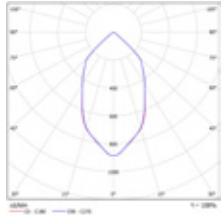

OP LT80

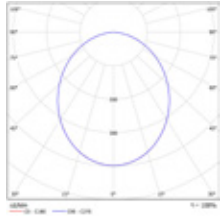

MPRZ LT92

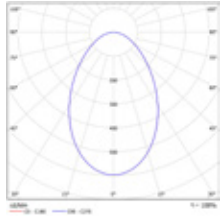

AURIGA C LED

Downlights



DESCRIPTION: **Recessed mounted LED downlight**
Light distribution type: direct
Optical system: clear glass diffuser, faceted aluminium reflector, 40°, low glare / opal PMMA diffuser / translucent micro-prismatic PMMA diffuser
Housing: aluminium
Colour: white, RAL9016

GENERAL DATA: **Mains voltage:** 220-240V, 0/50-60Hz
LED lifetime, h: 60000/L80B10
SDCM: 3
Protection class IEC: II
Ingress protection code: IP44
Mechanical impact resistance: IK04
Operating temperature range, °C: ta 0...+35

INSTALLATION: In ceilings with cut-out openings (mounting brackets included). Push-in terminal, 2x1x1.5mm²

ENVIRONMENT: Indoor

APPLICATION: Office, education, hotel, corridor, bathroom, retail, showroom, exhibition, public place

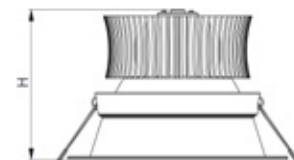
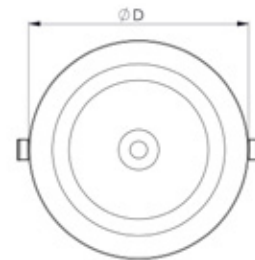

PRODUCT	DIAMETER, mm	HEIGHT, mm	CUT-OUT, mm	LUMINAIRE OUTPUT*, lm	SYSTEM POWER*, W	SYSTEM EFFICACY*, lm/W	CRI	CCT*,K	WEIGHT, kg
Auriga C LED1x1800 D336 T840 CLR	195	140	176	1813	13,5	134	80+	4000	0,8
Auriga C LED1x2400 D337 T840 CLR	195	140	176	2463	18,7	132	80+	4000	0,8
Auriga C LED1x3200 D338 T840 CLR	195	140	176	3316	26,5	125	80+	4000	0,8

*Tolerance range for optical and electrical data: ±10%. Values apply to an ambient temperature of 25°C. NORTHCLIFFE LIGHTING is constantly developing and improving its products. The right is reserved to change any product specifications without prior notification

AVAILABLE ACCESSORIES:



Product: Auriga C LED diffuser 135mm OP LT80
Description: Opal diffuser with high light transmittance



Product: Auriga C LED diffuser 135mm MPRZ LT92
Description: Translucent micro-prismatic diffuser with high light transmittance

OPTIONS AVAILABLE ON REQUEST:

LED	REFLECTOR AND OPTICS	CONTROL GEAR	EMERGENCY	CONNECTION	COLOUR
T830	OP LT80	DALI	EM3	WIE3-0.5m	RAL
T840	MPRZ LT92		EM3B	WIE5D-0.5m	
T930	OP TP(a)		EM3A	QBX2-0.1m	
T940			EM3D	Europlug-1.5m	
T927 NATURAL				Europlug-3.0m	
T930 NATURAL					
T940 NATURAL					

CLR

OP LT80

MPRZ LT92

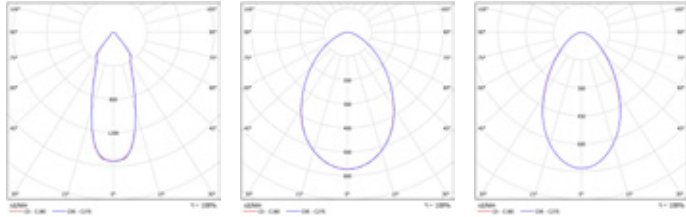

CRUX LED

Downlights



DESCRIPTION: **Recessed mounted LED downlight**
Light distribution type: direct
Optical system: opal polycarbonate diffuser
Housing: aluminium
Colour: white, RAL9016

GENERAL DATA: **Mains voltage:** 220-240V, 0/50-60Hz
LED lifetime, h: 50000/L80B10
SDCM: 3
Protection class IEC: II
Ingress protection code: IP44
Mechanical impact resistance: IK04
Operating temperature range, °C: ta 0...+35

INSTALLATION: In ceilings with cut-out openings (mounting brackets included). Screw terminal, 2x1x1.5mm²

ENVIRONMENT: Indoor

APPLICATION: Office, education, hotel, corridor, bathroom, retail, showroom, public place

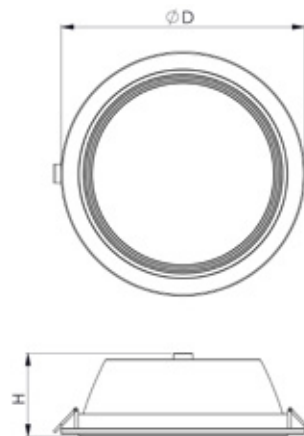

PRODUCT	DIAMETER, mm	HEIGHT, mm	CUT-OUT, mm	LUMINAIRE OUTPUT*, lm	SYSTEM POWER*, W	SYSTEM EFFICACY*, lm/W	CRI	CCT*, K	WEIGHT, kg
Crux LED1x1100 E307 T840 OP	200	90	185	1053	9,3	113	80+	4000	0,8
Crux LED1x1500 E308 T840 OP	200	90	185	1479	13,1	113	80+	4000	0,8
Crux LED1x2100 E309 T840 OP	200	90	185	2035	18,7	109	80+	4000	0,8
Crux LED1x1400 E310 T840 OP	235	90	220	1321	11,2	118	80+	4000	0,9
Crux LED1x1900 E311 T840 OP	235	90	220	1858	16,0	116	80+	4000	0,9
Crux LED1x2600 E312 T840 OP	235	90	220	2575	23,1	111	80+	4000	0,9

*Tolerance range for optical and electrical data: ±10%. Values apply to an ambient temperature of 25°C. NORTHCLIFFE LIGHTING is constantly developing and improving its products. The right is reserved to change any product specifications without prior notification

OPTIONS AVAILABLE ON REQUEST:

LED	CONTROL GEAR	EMERGENCY	CONNECTION	COLOUR
T830	DALI	EM3	WIE3-0.5m	RAL
T840		EM3B	WIE5D-0.5m	
		EM3A	QBX2-0.1m	
		EM3D	Europlug-1.5m	
			Europlug-3.0m	

OP

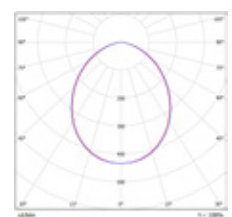

AURIGA P LED

Downlights



DESCRIPTION: **Recessed mounted LED downlight**
Light distribution type: direct
Optical system: faceted aluminium reflector, 60° / matt aluminium reflector, 80°, opal PMMA diffuser, low glare
Housing: aluminium
Colour: white, RAL9016

GENERAL DATA: **Mains voltage:** 220-240V, 50-60Hz
LED lifetime, h: 50000/L80B10
SDCM: 5
Protection class IEC: II
Ingress protection code: IP44
Mechanical impact resistance: IK04
Operating temperature range, °C: ta 0...+35

INSTALLATION: In ceilings with cut-out openings (mounting brackets included). Push-in terminal, 2x1x1.5mm²

ENVIRONMENT: Indoor

APPLICATION: Office, education, hotel, corridor, bathroom, retail, showroom, exhibition, public place

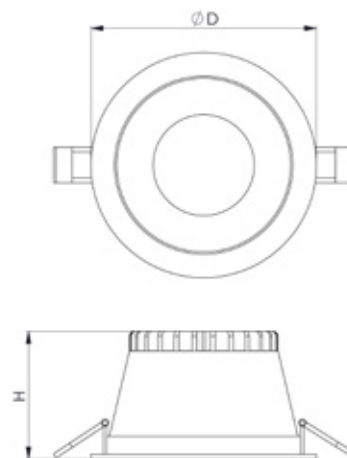

PRODUCT	DIAMETER, mm	HEIGHT, mm	CUT-OUT, mm	LUMINAIRE OUTPUT*, lm	SYSTEM POWER*, W	SYSTEM EFFICACY*, lm/W	CRI	CCT*, K	WEIGHT, kg
Auriga P LED1x950 J721 T840 R60	114	66	95	1021	10,2	100	80+	4000	0,3
Auriga P LED1x1900 G986 T840 R60	174	87	147	2100	18,8	112	80+	4000	0,4
Auriga P LED1x2550 G987 T840 R60	232	110	200	2520	28,0	90	80+	4000	0,7
Auriga P LED1x3350 J722 T840 R60	232	110	200	3325	35,0	95	80+	4000	0,7
Auriga P LED1x1100 J723 T840 R80	114	66	95	1326	10,1	131	80+	4000	0,3
Auriga P LED1x2400 G986 T840 R80	174	87	147	2730	18,5	148	80+	4000	0,4
Auriga P LED1x3350 G987 T840 R80	232	110	200	3846	27,9	138	80+	4000	0,7
Auriga P LED1x4050 J724 T840 R80	232	110	200	4414	33,3	133	80+	4000	0,7

*Tolerance range for optical and electrical data: ±10%. Values apply to an ambient temperature of 25°C. NORTHCLIFFE LIGHTING is constantly developing and improving its products. The right is reserved to change any product specifications without prior notification

OPTIONS AVAILABLE ON REQUEST:

LED	CONTROL GEAR	EMERGENCY	CONNECTION	OTHER
T830	DALI	EM3	WIE3-0.5m	RND BLACK
T840		EM3B	WIE5D-0.5m	SQ WHITE
T857		EM3A	QBX2-0.1m	SQ BLACK
		EM3D	Europlug-1.5m	GLASS WHITE
			Europlug-3.0m	GLASS BLACK

R60

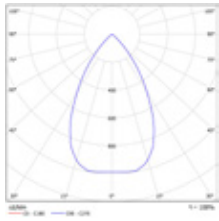

R80

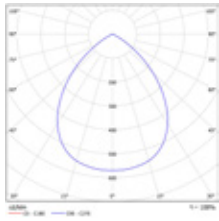

LUMINAIRE FRAME OPTIONS:



Option: RND BLACK

Description: Round luminaire frame in black, with dropped down glass cover



Options: SQ WHITE / SQ BLACK

Description: Square luminaire frame in white / black



Option: GLASS WHITE

Description: Round luminaire frame in white, with dropped down glass cover



Option: GLASS BLACK

Description: Round luminaire frame in black, with dropped down glass cover

CRUX P LED

Downlights



DESCRIPTION: Recessed mounted LED downlight
Light distribution type: direct
Optical system: opal polycarbonate diffuser
Housing: aluminium
Colour: white, RAL9016

GENERAL DATA: Mains voltage: 220-240V, 50-60Hz
 LED lifetime, h: 50000/L70B50
 SDCM: 5
 Protection class IEC: II
 Ingress protection code: IP44
 Mechanical impact resistance: IK04
 Operating temperature range, °C: ta
 0...+35

INSTALLATION: In ceilings with cut-out openings (mounting brackets included). Cable, 0.1m, 2x0.75mm²

ENVIRONMENT: Indoor

APPLICATION: Office, education, hotel, corridor, bathroom, retail, showroom, public place

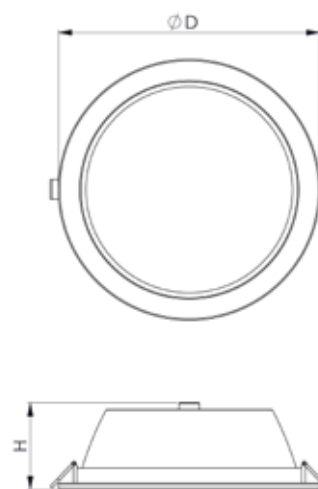

PRODUCT	DIAMETER, mm	HEIGHT, mm	CUT-OUT, mm	LUMINAIRE OUTPUT*, lm	SYSTEM POWER*, W	SYSTEM EFFICACY*, lm/W	CRI	CCT*, K	WEIGHT, kg
Crux P LED1x1000 E899 T840 OP	113	55	90	1025	10,0	103	80+	4000	0,4
Crux P LED1x1400 E900 T840 OP	143	59	117	1435	14,0	103	80+	4000	0,4
Crux P LED1x2000 E902 T840 OP	200	68	168	2050	20,0	103	80+	4000	0,7

*Tolerance range for optical and electrical data: ±10%. Values apply to an ambient temperature of 25°C. NORTHCLIFFE LIGHTING is constantly developing and improving its products. The right is reserved to change any product specifications without prior notification

OPTIONS AVAILABLE ON REQUEST:

LED	CONTROL GEAR	EMERGENCY	CONNECTION
T830	DALI	EM3	WIE3-0.5m
T840		EM3B	WIE5D-0.5m
		EM3A	QBX2-0.1m
		EM3D	Europlug-1.5m
			Europlug-3.0m

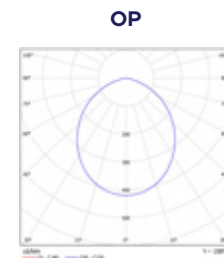

ANDROMEDA P LED

Downlights



DESCRIPTION: Recessed mounted basic LED downlight
Light distribution type: direct
Optical system: opal polycarbonate diffuser
Housing: polycarbonate
Colour: white, RAL9016

GENERAL DATA: Mains voltage: 220-240V, 50-60Hz
 LED lifetime, h: 40000/L70B50
 SDCM: 5
 Protection class IEC: II
 Ingress protection code: IP44
 Mechanical impact resistance: IK04
 Operating temperature range, °C: ta 0...+35

INSTALLATION: In ceilings with cut-out openings (mounting brackets included). Push-in terminal, 2x1x1.5 mm²

ENVIRONMENT: Indoor

APPLICATION: Office, education, hotel, corridor, bathroom, retail, showroom, public place

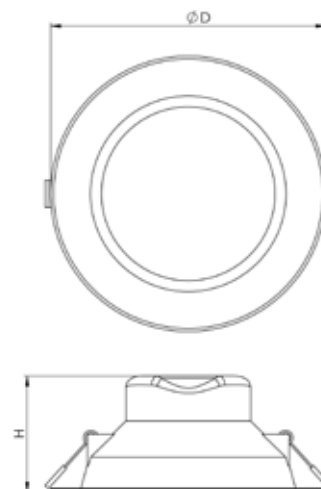

PRODUCT	DIAMETER, mm	HEIGHT, mm	CUT-OUT, mm	LUMINAIRE OUTPUT*, lm	SYSTEM POWER*, W	SYSTEM EFFICACY*, lm/W	CRI	CCT*, K	WEIGHT, kg
Andromeda P LED1x700 D522 T840 OP	92	64	75	700	7,0	100	80+	4000	0,2
Andromeda P LED1x1000 D523 T840 OP	113	73	95	980	10,0	98	80+	4000	0,2
Andromeda P LED1x1400 D524 T840 OP	174	79	150	1400	14,0	100	80+	4000	0,3
Andromeda P LED1x2100 D525 T840 OP	244	95	200	2060	20,0	103	80+	4000	0,6

*Tolerance range for optical and electrical data: ±10%. Values apply to an ambient temperature of 25°C. NORTHCLIFFE LIGHTING is constantly developing and improving its products. The right is reserved to change any product specifications without prior notification

OPTIONS AVAILABLE ON REQUEST:

LED
T830
T840

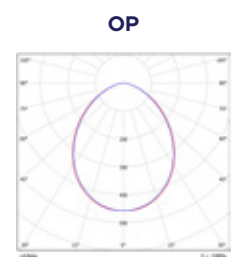

ROUND P LED

Downlights



DESCRIPTION: Recessed mounted basic LED downlight
Light distribution type: direct
Optical system: opal PMMA diffuser
Housing: aluminium
Colour: white, RAL9016

GENERAL DATA: Mains voltage: 220-240V, 50-60Hz
 LED lifetime, h: 50000/L80B50
 SDCM: 5
 Protection class IEC: II
 Ingress protection code: IP44
 Mechanical impact resistance: IK04
 Operating temperature range, °C: ta 0...+35

INSTALLATION: In ceilings with cut-out openings (mounting brackets included). Cable, 0.3m, 2x0.75 mm²

ENVIRONMENT: Indoor

APPLICATION: Office, education, hotel, corridor, bathroom, retail, showroom, public place

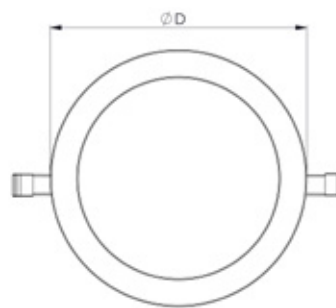

PRODUCT	DIAMETER, mm	HEIGHT, mm	CUT-OUT, mm	LUMINAIRE OUTPUT*, lm	SYSTEM POWER*, W	SYSTEM EFFICACY*, lm/W	CRI	CCT*, K	WEIGHT, kg
Round P LED1x400 G286 T840 OP IP44	120	11	105	465	6,0	78	80+	4000	0,2
Round P LED1x750 G287 T840 OP IP44	145	11	130	812	9,0	90	80+	4000	0,2
Round P LED1x950 G288 T840 OP IP44	170	11	155	1036	12,0	86	80+	4000	0,3
Round P LED1x1200 G599 T840 OP IP44	190	11	175	1420	15,0	95	80+	4000	0,3
Round P LED1x1450 G289 T840 OP IP44	220	11	205	1685	18,0	94	80+	4000	0,4
Round P LED1x2250 G580 T840 OP IP44	295	11	280	2236	24,0	93	80+	4000	0,7

*Tolerance range for optical and electrical data: ±10%. Values apply to an ambient temperature of 25°C. NORTHCLIFFE LIGHTING is constantly developing and improving its products. The right is reserved to change any product specifications without prior notification

OPTIONS AVAILABLE ON REQUEST:

LED	CONTROL GEAR	EMERGENCY	CONNECTION
T830	DALI	EM3	WIE3-0.5m
T840		EM3B	WIE5D-0.5m
			QBX2-0.1m
			Europlug-1.5m
			Europlug-3.0m

OP

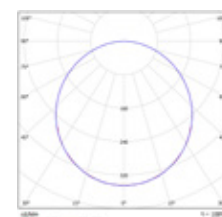



TETRA A LED

Downlights



DESCRIPTION: **Recessed mounted LED downlight**
Light distribution type: direct
Optical system: translucent micro-prismatic PMMA diffuser
Housing: steel
Colour: white, RAL9003S

GENERAL DATA: **Mains voltage:** 220-240V, 0/50-60Hz
LED lifetime, h: 50000/L80B10 (75000/L80B50 low power versions)
SDCM: 3
Protection class IEC: II
Ingress protection code: IP44
Mechanical impact resistance: IK05
Operating temperature range, °C: ta 0...+35

INSTALLATION: In ceilings with cut-out openings (mounting brackets included). Push-in terminal, 2x1x1.5 mm²

ENVIRONMENT: Indoor

APPLICATION: Office, education, hotel, corridor, bathroom, retail, showroom, public place

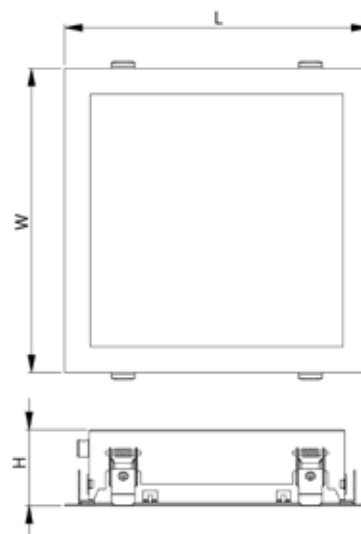

PRODUCT	LENGTH, mm	WIDTH, mm	HEIGHT, mm	CUT-OUT, mm	LUMINAIRE OUTPUT*, lm	SYSTEM POWER*, W	SYSTEM EFFICACY*, lm/W	CRI	CCT*, K	WEIGHT, kg
Tetra A LED1x1200 D984 T840 MPRZ LT92	260	260	65	245x240	1167	10,2	114	80+	4000	1,5
Tetra A LED1x1650 D985 T840 MPRZ LT92	260	260	65	245x240	1631	14,7	111	80+	4000	1,5
Tetra A LED1x2200 D986 T840 MPRZ LT92	260	260	65	245x240	2197	20,1	109	80+	4000	1,5
Tetra A LED1x2700 D987 T840 MPRZ LT92	260	260	65	245x240	2688	27,6	97	80+	4000	1,5

*Tolerance range for optical and electrical data: ±10%. Values apply to an ambient temperature of 25°C. NORTHCLIFFE LIGHTING is constantly developing and improving its products. The right is reserved to change any product specifications without prior notification

OPTIONS AVAILABLE ON REQUEST:

LED	CONTROL GEAR	EMERGENCY	CONNECTION	COLOUR
T830	DALI	EM3	WIE3-0.5m	RAL
T840		EM3B	WIE5D-0.5m	
		EM3A	QBX2-0.1m	
		EM3D	Europlug-1.5m	
			Europlug-3.0m	

MPRZ LT92

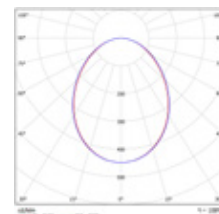

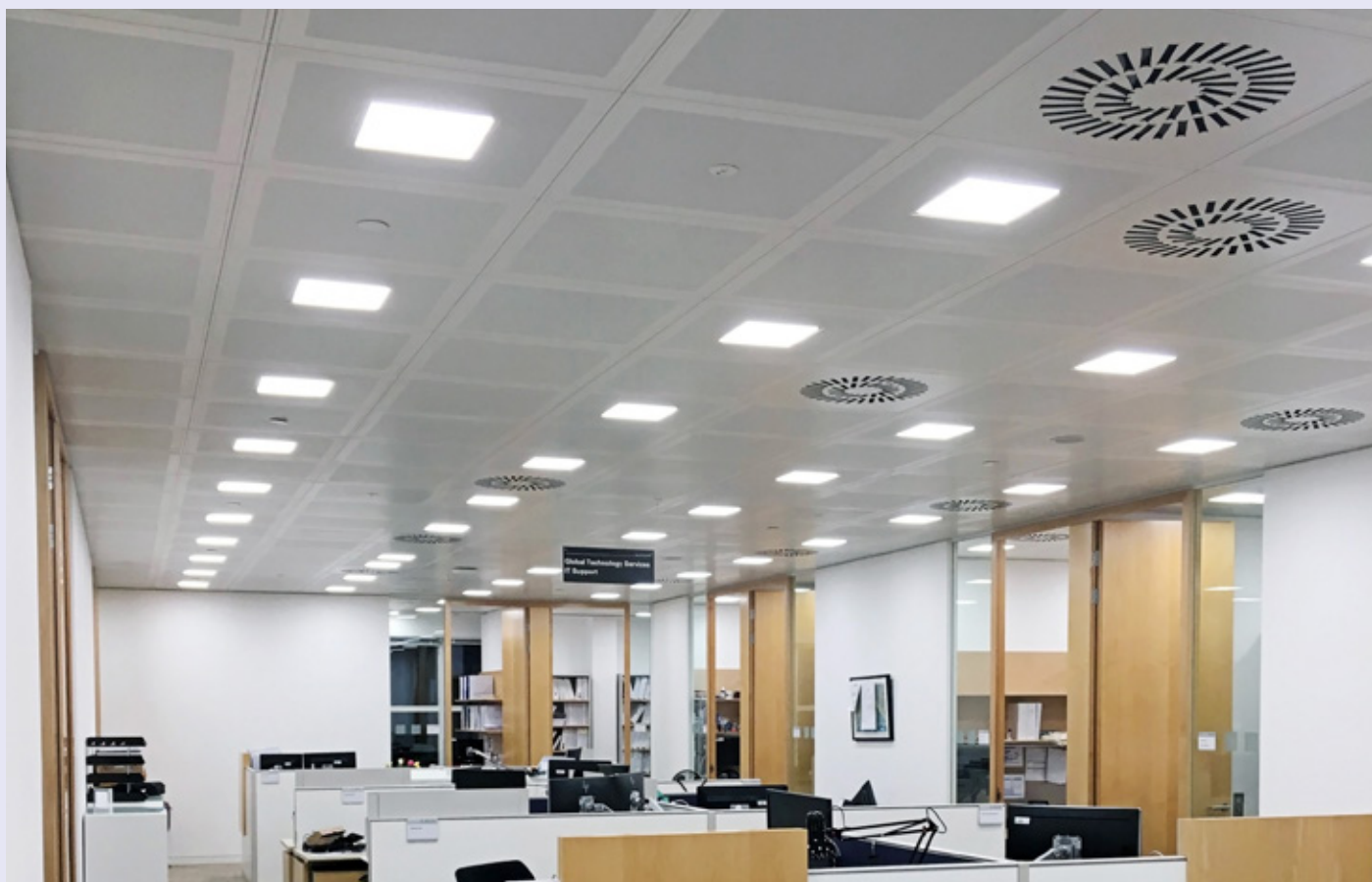

TETRA R LED

Downlights

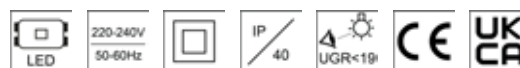

DESCRIPTION: **Recessed mounted LED downlight**
Light distribution type: direct
Optical system: double parabolic reflector with lenses, low glare
Housing: steel
Colour: white, RAL9003S

GENERAL DATA: **Mains voltage:** 220-240V, 50-60Hz
LED lifetime, h: 60000/L80B10
SDCM: 3
Protection class IEC: II
Ingress protection code: IP40
Mechanical impact resistance: IK04
Operating temperature range, °C: ta 0...+35

INSTALLATION: In ceilings with cut-out openings (mounting brackets included). Push-in terminal, 2x1x1.5mm²

ENVIRONMENT: Indoor

APPLICATION: Office, education, hotel, corridor, bathroom, retail, showroom, public place

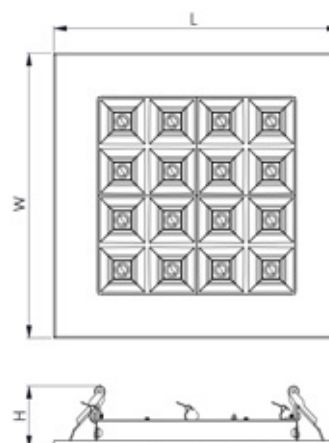

PRODUCT	LENGTH, mm	WIDTH, mm	HEIGHT, mm	CUT-OUT, mm	LUMINAIRE OUTPUT*, lm	SYSTEM POWER*, W	SYSTEM EFFICACY*, lm/W	CRI	CCT*, K	WEIGHT, kg
Tetra R LED 1x850 J690 T840 WGC	130	130	37	110x90	847	6,1	139	80+	4000	0,3
Tetra R LED 1x1150 J691 T840 WGC	130	130	37	110x90	1102	8,1	136	80+	4000	0,3
Tetra R LED 1x2300 J575 T840 WGC	230	230	37	210x180	2275	14,6	156	80+	4000	0,9
Tetra R LED 1x3300 J576 T840 WGC	230	230	37	210x180	2873	18,3	157	80+	4000	0,9
Tetra R LED 1x3800 J577 T840 WGC	230	230	37	210x180	3777	26,6	142	80+	4000	0,9

*Tolerance range for optical and electrical data: ±10%. Values apply to an ambient temperature of 25°C. NORTHCLIFFE LIGHTING is constantly developing and improving its products. The right is reserved to change any product specifications without prior notification

OPTIONS AVAILABLE ON REQUEST:

LED	REFLECTOR AND OPTICS	CONTROL GEAR	EMERGENCY	CONNECTION	COLOUR
T830	WGC	DALI	EM3 ¹	WIE3-0.5m	RAL
T840	BGC		EM3B ^{1 2}	WIE5D-0.5m	
	WMC		EM3A ^{1 2}	Europlug-1.5m	
	BMC		EM3D ^{1 2}	Europlug-3.0m	

1 Operating temperature range for Luminaires with EM option, C: ta 0... +35

2 EM3B/A/D options not available for models: J690, J691

WGC

BGC

WMC

BMC

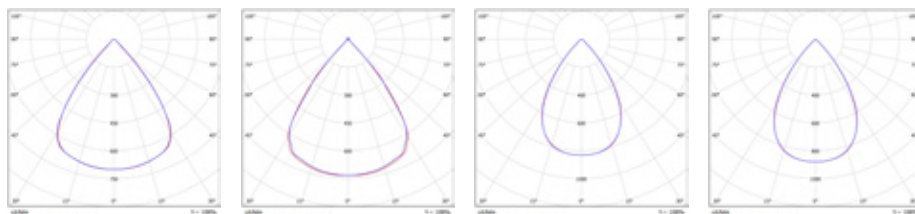

TETRA S LED

Downlights



DESCRIPTION: **Surface mounted LED downlight**
Light distribution type: direct
Optical system: double parabolic reflector with lenses, low glare
Housing: steel
Colour: white, RAL9003S

GENERAL DATA: **Mains voltage:** 220-240V, 50-60Hz
LED lifetime, h: 60000/L80B10
SDCM: 3
Protection class IEC: I
Ingress protection code: IP40
Mechanical impact resistance: IK04
Operating temperature range, °C: ta 0...+35

INSTALLATION: On the ceiling. Push-in terminal, 3x2x2.5mm²

ENVIRONMENT: Indoor

APPLICATION: Office, education, hotel, corridor, bathroom, retail, showroom, public place

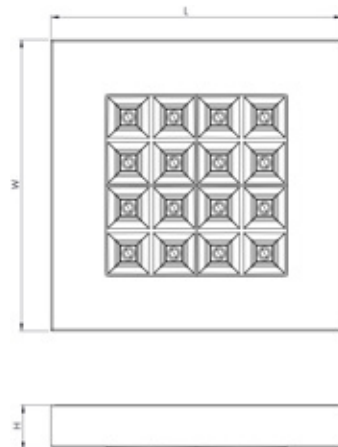

PRODUCT	LENGTH, mm	WIDTH, mm	HEIGHT, mm	LUMINAIRE OUTPUT*, lm	SYSTEM POWER*, W	SYSTEM EFFICACY*, lm/W	CRI	CCT*, K	WEIGHT, kg
Tetra S LED 1x2300 J578 T840 WGC	255	255	37	2275	14,8	154	80+	4000	1,4
Tetra S LED 1x3300 J579 T840 WGC	255	255	37	2873	18,3	157	80+	4000	1,4
Tetra S LED 1x3800 J580 T840 WGC	255	255	37	3777	26,3	144	80+	4000	1,4

*Tolerance range for optical and electrical data: ±10%. Values apply to an ambient temperature of 25°C. NORTHCLIFFE LIGHTING is constantly developing and improving its products. The right is reserved to change any product specifications without prior notification

OPTIONS AVAILABLE ON REQUEST:

LED	REFLECTOR AND OPTICS	CONTROL GEAR	COLOUR
T830	WGC	DALI	RAL
T840	BGC		
	WMC		
	BMC		

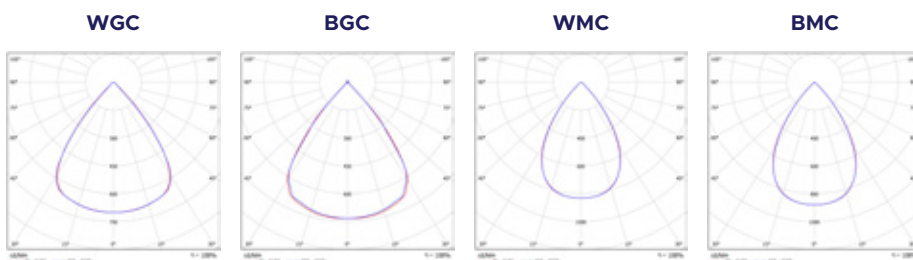

ANTLIA LED

Downlights

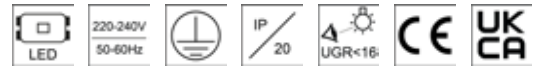

DESCRIPTION: **Surface mounted LED downlight**
Light distribution type: direct
Optical system: faceted aluminium reflector, 40°, low glare
Housing: aluminium
Colour: white, RAL9016

GENERAL DATA: **Mains voltage:** 220-240V, 50-60Hz (220-240V, 0/50-60Hz for model D344)
LED lifetime, h: 60000/L80B10
SDCM: 3
Protection class IEC: I
Ingress protection code: IP20
Mechanical impact resistance: IK02
Operating temperature range, °C: ta 0...+35

INSTALLATION: On the ceiling or suspended. Push-in terminal, 3x2x2.5mm²

ENVIRONMENT: Indoor

APPLICATION: Office, education, hotel, corridor, bathroom, retail, showroom, exhibition, public place

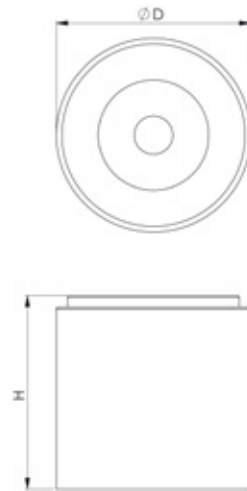

PRODUCT	DIAMETER, mm	HEIGHT, mm	LUMINAIRE OUTPUT*, lm	SYSTEM POWER*, W	SYSTEM EFFICACY*, lm/W	CRI	CCT*, K	WEIGHT, kg
Antlia LED1x1800 D342 T840	168	172	1813	13,5	134	80+	4000	1,0
Antlia LED1x2400 D343 T840	168	172	2463	19,8	124	80+	4000	1,0
Antlia LED1x3200 D344 T840	168	172	3316	26,8	124	80+	4000	1,0

*Tolerance range for optical and electrical data: ±10%. Values apply to an ambient temperature of 25°C. NORTHCLIFFE LIGHTING is constantly developing and improving its products. The right is reserved to change any product specifications without prior notification

AVAILABLE ACCESSORIES:



Product: Suspension MTG KIT SUSI
Description: Suspension wire set "I" type, 1.5m adjustable, 1pcs
**note - 1pcs MTG KIT SUSI for one fitting required*
**note - SUS option is required*

OPTIONS AVAILABLE ON REQUEST:

LED	CONTROL GEAR	CONNECTION	OTHER	COLOUR
T830	DALI	1G	SUS	RAL
T840				
T927 NATURAL				
T930 NATURAL				
T940 NATURAL				

STANDARD

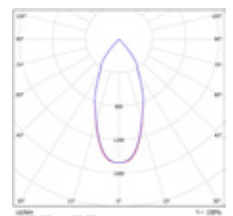

ANTLIA C LED

Downlights



DESCRIPTION: **Surface mounted LED downlight**
Light distribution type: direct
Optical system: opal polycarbonate diffuser
Housing: aluminium
Colour: white, RAL9016

GENERAL DATA: **Mains voltage:** 220-240V, 50-60Hz
LED lifetime, h: 60000/L80B10
SDCM: 3
Protection class IEC: I
Ingress protection code: IP44
Mechanical impact resistance: IK04
Operating temperature range, °C: ta 0...+35

INSTALLATION: On the ceiling or suspended. Push-in terminal, 3x2x2.5mm²

ENVIRONMENT: Indoor

APPLICATION: Office, education, hotel, corridor, bathroom, retail, showroom, exhibition, public place

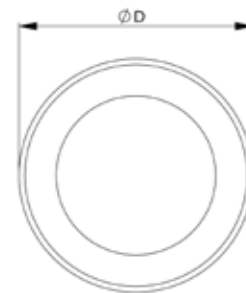

PRODUCT	DIAMETER, mm	HEIGHT, mm	LUMINAIRE OUTPUT*, lm	SYSTEM POWER*, W	SYSTEM EFFICACY*, lm/W	CRI	CCT*, K	WEIGHT, kg
Antlia C LED1x1400 D345 T840 OP	200	130	1321	11,8	112	80+	4000	1,0
Antlia C LED1x1900 D346 T840 OP	200	130	1858	16,0	116	80+	4000	1,0
Antlia C LED1x2600 D347 T840 OP 1G	200	130	2575	23,1	112	80+	4000	1,0

*Tolerance range for optical and electrical data: ±10%. Values apply to an ambient temperature of 25°C. NORTHCLIFFE LIGHTING is constantly developing and improving its products. The right is reserved to change any product specifications without prior notification

AVAILABLE ACCESSORIES:



Product: Suspension MTG KIT SUSI
Description: Suspension wire set "I" type, 1.5m adjustable, 1pcs
**note - 3pcs MTG KIT SUSI for one fitting required*
**note - SUS option is required*

OPTIONS AVAILABLE ON REQUEST:

LED	CONTROL GEAR	EMERGENCY	OTHER	COLOUR
T830	DALI	EM3	SUS	RAL
T840		EM3B ¹		

¹ EM3B options not applicable for models: D347

STANDARD

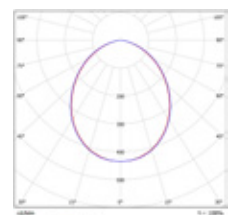



PERSEUS C LED

Downlights



DESCRIPTION: **Recessed mounted waterproof LED downlight**
Light distribution type: direct
Optical system: faceted aluminium reflector, 50°, low glare, tempered glass diffuser, silicon rubber gasket
Housing: aluminium
Colour: white, RAL9016

GENERAL DATA: **Mains voltage:** 220-240V, 0/50-60Hz (220-240V, 50-60Hz for model E958)
LED lifetime, h: 60000/L80B10
SDCM: 3
Protection class IEC: II
Ingress protection code: IP65
Mechanical impact resistance: IK05
Operating temperature range, °C: ta -20...+35

INSTALLATION: In ceilings with cut-out openings (mounting brackets included). Cable, 0.3m, 2x0.75mm²

ENVIRONMENT: Indoor

APPLICATION: Office, hotel, bathroom, retail, showroom, exhibition, public place

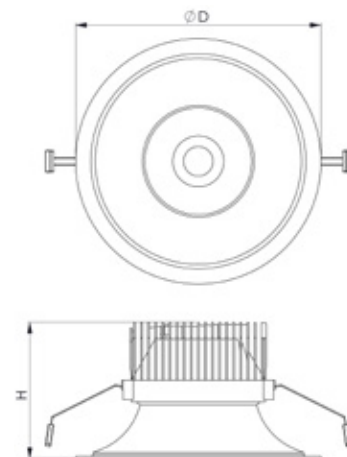

PRODUCT	DIAMETER, mm	HEIGHT, mm	CUT-OUT, mm	LUMINAIRE OUTPUT*, lm	SYSTEM POWER*, W	SYSTEM EFFICACY*, lm/W	CRI	CCT*, K	WEIGHT, kg
Perseus C LED1x2450 E956 T840 CLR	225	90	205	2493	19,8	126	80+	4000	1,2
Perseus C LED1x3200 E957 T840 CLR	225	90	205	3357	27,1	124	80+	4000	1,2
Perseus C LED1x4100 J214 T840 CLR	225	90	205	4211	35,1	120	80+	4000	1,2
Perseus C LED1x4600 E958 T840 CLR	225	90	205	4809	42,1	114	80+	4000	1,2

*Tolerance range for optical and electrical data: ±10%. Values apply to an ambient temperature of 25°C. NORTHCLIFFE LIGHTING is constantly developing and improving its products. The right is reserved to change any product specifications without prior notification

OPTIONS AVAILABLE ON REQUEST:

LED	CONTROL GEAR	EMERGENCY	COLOUR
T830	T930 NATURAL	DALI	RAL
T840	T940 NATURAL	EM3B ¹	
T927 NATURAL			

¹ Operating temperature range for Luminaires with EM option, °C: ta 0... +35

STANDARD

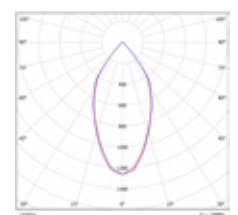



HIGH-BAYS



PRIZMA A LED

High-bays

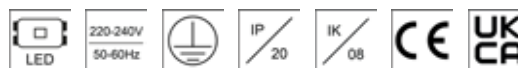

DESCRIPTION:	Suspended low-bay LED luminaire Light distribution type: direct Optical system: prismatic polycarbonate reflector and lenses Housing: aluminium Colour: dark grey, RAL7043
GENERAL DATA:	Mains voltage: 220-240V, 50-60Hz LED lifetime, h: 100000/L80B50 SDCM: 4 Protection class IEC: I Ingress protection code: IP20 Mechanical impact resistance: IK08 Operating temperature range, °C: ta 0...+40
INSTALLATION:	Suspended (hook for wire suspension included). Push-in terminal, 3x2x2.5mm ²
ENVIRONMENT:	Indoor
APPLICATION:	Retail, showroom, hall, exhibition, public place

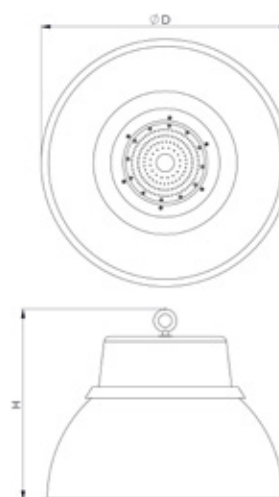

PRODUCT	DIAMETER, mm	HEIGHT, mm	LUMINAIRE OUTPUT*, lm	SYSTEM POWER*, W	SYSTEM EFFICACY*, lm/W	CRI	CCT*, K	WEIGHT, kg
Prizma A LED1x4200 J608 T840	410	289	4200	27,0	156	80+	4000	2,5
Prizma A LED1x6000 J609 T840	410	289	6000	39,0	154	80+	4000	2,5
Prizma A LED1x8400 J610 T840	410	289	8400	55,0	153	80+	4000	2,5
Prizma A LED1x10800 J611 T840	410	289	10800	71,0	152	80+	4000	2,5
Prizma A LED1x12600 J612 T840	410	289	12600	82,0	154	80+	4000	2,5

*Tolerance range for optical and electrical data: ±10%. Values apply to an ambient temperature of 25°C. NORTHCLIFFE LIGHTING is constantly developing and improving its products. The right is reserved to change any product specifications without prior notification

OPTIONS AVAILABLE ON REQUEST:

LED	CONTROL GEAR	CONNECTION	COLOUR
T830	DALI	CBF3-2.0m clear	RAL
T840		CBF3-3.0m clear	
		CBF5-2.0m clear	
		CBF5-3.0m clear	

STANDARD

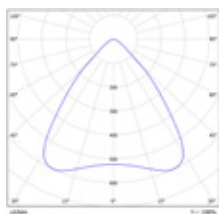



NORTE I LED

High-bays

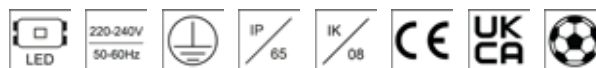

DESCRIPTION: Surface mounted or suspended high-bay LED luminaire
Light distribution type: direct
Optical system: lenses, silicone rubber gasket, impact resistance
Housing: aluminium / steel
Colour: white, RAL9003

GENERAL DATA: **Mains voltage:** 220-240V, 0/50-60Hz
LED lifetime, h: 100000/L80B10
SDCM: 3
Protection class IEC: I
Ingress protection code: IP65
Mechanical impact resistance: IK08 (IK10 with protection grid)
Protection symbol: D
Operating temperature range, °C: ta -20...+35/ +40

INSTALLATION: On the ceiling or wall, or suspended (requires accessories). Push-in terminal, 5x2x2.5mm²

ENVIRONMENT: Indoor

APPLICATION: Industry, warehouse, hall, sports, transport terminal

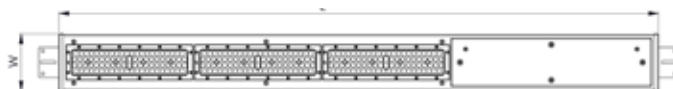

Models: G106, G107, G108

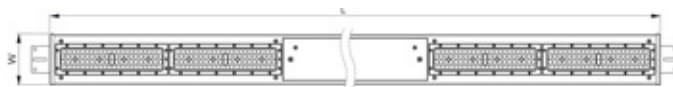

Models: G103, G104, G105, G110, G111, G116, G112, G113, G114, G115

PRODUCT	LENGTH, mm	WIDTH, mm	HEIGHT, mm	LUMINAIRE OUTPUT*, lm	SYSTEM POWER*, W	SYSTEM EFFICACY*, lm/W	CRI	CCT*, K	WEIGHT, kg
Norte I LED1x10500 G103 T840 ALU L75	935	114	80	10031	58,7	171	80+	4000	1,5
Norte I LED1x12350 G104 T840 ALU L75	935	114	80	11829	70,1	169	80+	4000	1,5
Norte I LED1x14250 G105 T840 ALU L75	935	114	80	13640	82,5	165	80+	4000	1,5
Norte I LED1x15650 G106 T840 ALU L75	1190	114	80	14969	86,9	172	80+	4000	2,2
Norte I LED1x18550 G107 T840 ALU L75	1190	114	80	17743	104,0	171	80+	4000	2,2
Norte I LED1x21250 G108 T840 ALU L75	1190	114	80	20355	122,1	167	80+	4000	2,2
Norte I LED1x20900 G110 T840 ALU L75	1444	114	80	19959	114,6	174	80+	4000	2,8
Norte I LED1x24700 G111 T840 ALU L75	1444	114	80	23657	137,2	172	80+	4000	2,8
Norte I LED1x26450 G116 T840 ALU L75	1444	114	80	25315	149,6	169	80+	4000	2,8
Norte I LED1x28350 G112 T840 ALU L75	1444	114	80	27140	162,8	167	80+	4000	2,8
Norte I LED1x31100 G113 T840 ALU L75	1953	114	80	29784	173,2	172	80+	4000	4,1
Norte I LED1x36900 G114 T840 ALU L75	1953	114	80	35302	207,4	170	80+	4000	4,1
Norte I LED1x42300 G115 T840 ALU L75	1953	114	80	40499	243,5	166	80+	4000	4,1

*Tolerance range for optical and electrical data: ±10%. Values apply to an ambient temperature of 25°C. NORTHCLIFFE LIGHTING is constantly developing and improving its products. The right is reserved to change any product specifications without prior notification

AVAILABLE ACCESSORIES:



Product: Suspension MTG KIT - Norte I LED 1.5m
Description: Suspension kit for Norte I LED highbay, 1.5 meter



Product: Suspension MTG KIT - Norte I LED 3.0m
Description: Suspension kit for Norte I LED highbay, 3.0 meter

Product: Suspension MTG KIT - Norte I LED 5.0m
Description: Suspension kit for Norte I LED highbay, 5.0 meter

Product: Adjustable brackets MTG KIT - Norte I LED
Description: Ceiling and wall mounting brackets for Norte I LED with angle adjustment +/-75 degrees (every 15), galvanized steel, 2pcs



Product: Remote Control HRC-11
Description: Integrated smart sensor for high ceiling (up to 16m) with wireless communication and grouping possibilities for lighting control
**note - remote control for HBPIR15m-M*



Product: Wire suspension BRACKETS - Norte I LED
Description: Wire suspension brackets for Norte I LED highbay, 2pcs



Product: GRID MTG KIT Norte I LED - 980x114mm RAL9003
Description: Protective grid for Norte I LED luminaires up to size 980x114mm, white

Product: GRID MTG KIT Norte I LED - 1235x114mm RAL9003
Description: Protective grid for Norte I LED luminaires up to size 1235x114mm, white

Product: GRID MTG KIT Norte I LED - 1490x114mm RAL9003
Description: Protective grid for Norte I LED luminaires up to size 1490x114mm, white

Product: GRID MTG KIT Norte I LED - 1998x114mm RAL9003
Description: Protective grid for Norte I LED luminaires up to size 1998x114mm, white

OPTIONS AVAILABLE ON REQUEST:

LED	REFLECTOR AND OPTICS	COVERS	CONTROL GEAR	SENSORS	EMERGENCY	CONNECTION
T830	L30x65	SPORT	DALI ¹	HBPIR15m-M ⁵	EM3 ⁷	1LIN
T840	L40		HBEAIRB-M ^{2 3 4}	DALI HBPIRD15m-M ^{3 6}	EM3B ⁷	2LIN
T857	L60		HBEAIRB-S ^{2 4}	KRBLT HBPIR15m-M ³	EM3A ⁷	3LIN
T865	L75		COR	DALI KRBLT HBPIRD15m-M ^{3 6}	EM3D ⁷	1LIN2.5
	L90x90		COR1min			2LIN2.5
	L120		COR30min			3LIN2.5
	L1A50		KRBLT			
			KRBLT DALI			

- For models with power above 155W two DALI addresses are used
- Max system size 1x HBEAIRB-M + 1x HBEAIRB-S
- The impact protection rating of the HBEAIRB-M, HBPIR15m-M, DALI HBPIRD15m-M, KRBLT HBPIR15m-M, DALI KRBLT HBPIRD15m-M options is IK05, except when the SPORT option is used
- Max wire length from HBEAIRB-M to last HBEAIRB-S - 11 m
- Max switching load up to 2A
- Max. 15 DALI slaves
- Operating temperature range for Luminaires with EM option, °C: ta 0... +35

L30x65

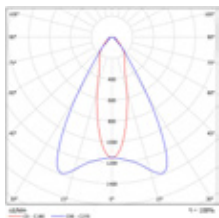

L40

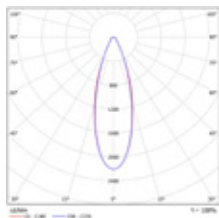

L60

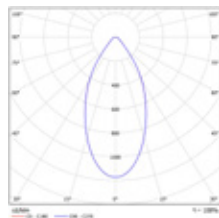

L75

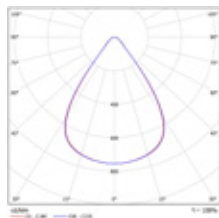

L90x90

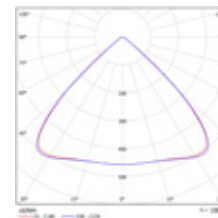

L120

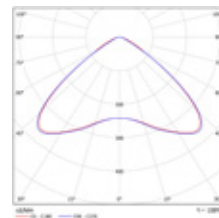

L1A50

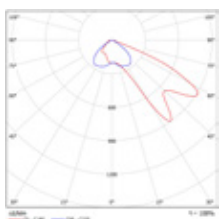





NORTE C LED

High-bays



DESCRIPTION: **Surface mounted or suspended high-bay LED luminaire for use in low temperatures -35°C environments**
Light distribution type: direct
Optical system: lenses, silicone rubber gasket, impact resistance
Housing: aluminium
Colour: white, RAL9003

GENERAL DATA: **Mains voltage:** 220-240V, 0/50-60Hz
LED lifetime, h: 100000/L80B10
SDCM: 3
Protection class IEC: I
Ingress protection code: IP65
Mechanical impact resistance: IK08
Protection symbol: D
Operating temperature range, °C: ta -35...+35°C

INSTALLATION: On the ceiling or suspended. Cable 2.0m, 3x1.5mm²

ENVIRONMENT: Indoor

APPLICATION: Cold storage, industry, warehouse, transport terminal

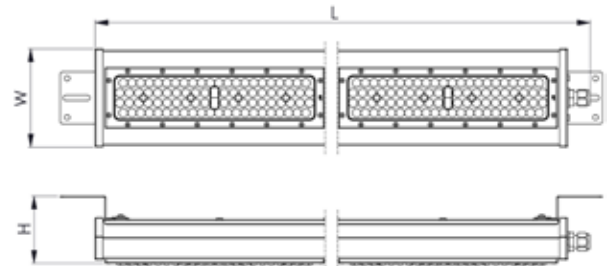

PRODUCT	LENGTH, mm	WIDTH, mm	HEIGHT, mm	LUMINAIRE OUTPUT*, lm	SYSTEM POWER*, W	SYSTEM EFFICACY*, lm/W	CRI	CCT*, K	WEIGHT, kg
Norte C LED1x10700 G331 T840 L75 CBF3-2.0m Tmin-35	554	114	80	10237	61,2	167	80+	4000	1,8
Norte C LED1x16050 G332 T840 L75 CBF3-2.0m Tmin-35	807	114	80	15355	89,8	171	80+	4000	2,0
Norte C LED1x21400 G333 T840 L75 CBF3-2.0m Tmin-35	1060	114	80	20474	117,2	175	80+	4000	2,4

*Tolerance range for optical and electrical data: ±10%. Values apply to an ambient temperature of 25°C. NORTHCLIFFE LIGHTING is constantly developing and improving its products. The right is reserved to change any product specifications without prior notification

AVAILABLE ACCESSORIES:



Product: Suspension MTG KIT - Norte I LED 1.5m
Description: Suspension kit for Norte I LED highbay, 1.5 meter

Product: Suspension MTG KIT - Norte I LED 3.0m
Description: Suspension kit for Norte I LED highbay, 3.0 meter

Product: Suspension MTG KIT - Norte I LED 5.0m
Description: Suspension kit for Norte I LED highbay, 5.0 meter



Product: Wire suspension BRACKETS - Norte I LED

Description: Wire suspension brackets for Norte I LED highbay, 2pcs

OPTIONS AVAILABLE ON REQUEST:

LED	REFLECTOR AND OPTICS	CONTROL GEAR
T830	L30x65	DALI
T840	L40	COR
T857	L60	COR1min
T865	L75	COR30min
	L90x90	
	L120	

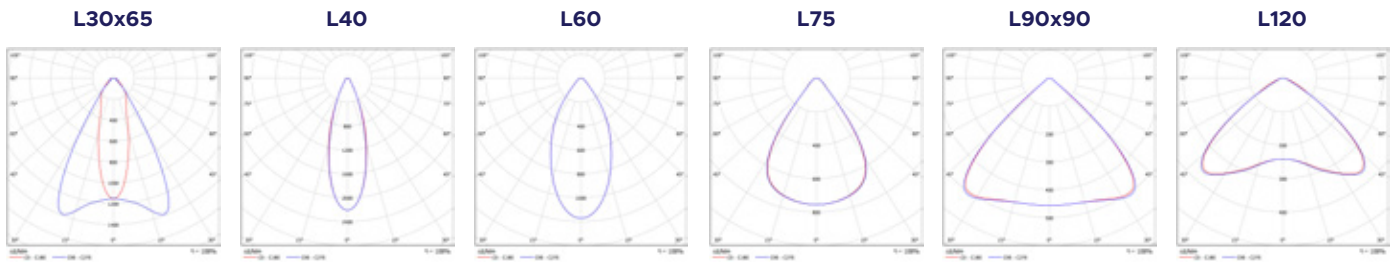

NORTE L LED

High-bays

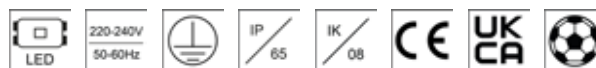

DESCRIPTION: **Surface mounted or suspended high-bay LED luminaire**
Light distribution type: direct
Optical system: lenses, silicone rubber gasket, impact resistance
Housing: aluminium / steel
Colour: white, RAL9003

GENERAL DATA: **Mains voltage:** 220-240V, 0/50-60Hz
LED lifetime, h: 100000/L80B10
SDCM: 3
Protection class IEC: I
Ingress protection code: IP65
Mechanical impact resistance: IK08 (IK10 with protection grid)
Protection symbol: D
Operating temperature range, °C: ta -20...+40 (D577, D578, D581, D582, D585: ta -20...+35)

INSTALLATION: On the ceiling or wall, or suspended (requires accessories). Push-in terminal, 5x2x2.5mm²

ENVIRONMENT: Indoor

APPLICATION: Industry, warehouse, hall, sports, transport terminal

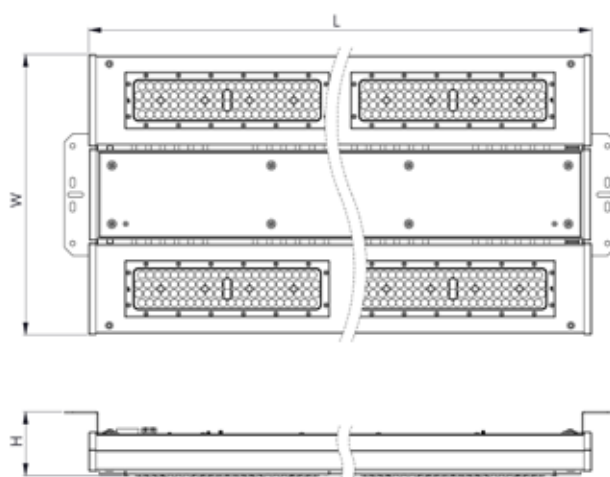

PRODUCT	LENGTH, mm	WIDTH, mm	HEIGHT, mm	LUMINAIRE OUTPUT*, lm	SYSTEM POWER*, W	SYSTEM EFFICACY*, lm/W	CRI	CCT*, K	WEIGHT, kg
Norte L LED1x7500 D574 T840 ALU L75	435	343	78	7162	40,5	177	80+	4000	2,8
Norte L LED1x8500 D575 T840 ALU L75	435	343	78	8130	46,5	175	80+	4000	2,8
Norte L LED1x10500 D576 T840 ALU L75	435	343	78	10031	58,7	171	80+	4000	2,8
Norte L LED1x12350 D577 T840 ALU L75	435	343	78	11829	70,1	169	80+	4000	2,8
Norte L LED1x14250 D578 T840 ALU L75	435	343	78	13640	82,5	165	80+	4000	2,8
Norte L LED1x17000 D579 T840 ALU L75	645	343	78	16260	91,1	179	80+	4000	4,3
Norte L LED1x20850 D580 T840 ALU L75	645	343	78	19959	114,6	174	80+	4000	4,3
Norte L LED1x24700 D581 T840 ALU L75	645	343	78	23657	138,7	171	80+	4000	4,3
Norte L LED1x28350 D582 T840 ALU L75	645	343	78	27140	162,8	167	80+	4000	4,3
Norte L LED1x31100 D583 T840 ALU L75	945	343	78	29784	171,4	174	80+	4000	6,5
Norte L LED1x36900 D584 T840 ALU L75	945	343	78	35302	207,4	170	80+	4000	6,5
Norte L LED1x42300 D585 T840 ALU L75	945	343	78	40499	243,5	166	80+	4000	6,5

*Tolerance range for optical and electrical data: ±10%. Values apply to an ambient temperature of 25°C. NORTHCLIFFE LIGHTING is constantly developing and improving its products. The right is reserved to change any product specifications without prior notification

AVAILABLE ACCESSORIES:



Product: Suspension MTG KIT - Norte L LED 1.5m
Description: Suspension kit for Norte L LED highbay, 1.5 meter



Product: Wire suspension BRACKETS - Norte L LED
Description: Wire suspension brackets for Norte L LED highbay, 2pcs



Product: Suspension MTG KIT - Norte L LED 3.0m
Description: Suspension kit for Norte L LED highbay, 3.0 meter

Product: Suspension MTG KIT - Norte L LED 5.0m
Description: Suspension kit for Norte L LED highbay, 5.0 meter



Product: GRID MTG KIT Norte L LED - 435x340mm RAL9003
Description: Protective grid for Norte L LED luminaires up to size 435x340, white

Product: GRID MTG KIT Norte L LED - 645x340mm RAL9003
Description: Protective grid for Norte L LED luminaires up to size 645x340, white

Product: GRID MTG KIT Norte L LED - 945x340mm RAL9003
Description: Protective grid for Norte L LED luminaires up to size 945x340, white



Product: Adjustable brackets MTG KIT - Norte L LED
Description: Ceiling and wall mounting brackets for Norte L LED with angle adjustment +/-75 degrees (every 15), galvanized steel, 2pcs

Product: Remote Control HRC-11
Description: Integrated smart sensor for high ceiling (up to 16m) with wireless communication and grouping possibilities for lighting control
**note - remote control for HBPIR15m-M*

OPTIONS AVAILABLE ON REQUEST:

LED	REFLECTOR AND OPTICS	COVERS	CONTROL GEAR	SENSORS	EMERGENCY	CONNECTION
T830	L30x65	SPORT	DALI ¹	HBPIR15m-M ^{3 5}	EM3 ⁷	1LIN
T840	L40		HBEAIRB-M ^{2 3 4}	DALI HBPIRD15m-M ^{3 6}	EM3B ⁷	2LIN
T857	L60		HBEAIRB-S ^{2 4}	KRBLT HBPIR15m-M ³	EM3A ⁷	3LIN
T865	L75		COR	DALI KRBLT HBPIRD15m-M ^{3 6}	EM3D ⁷	1LIN2.5
	L90x90		COR1min			2LIN2.5
	L120		COR30min			3LIN2.5
	L1A50		KRBLT			
			KRBLT DALI			

- For models with power above 155W two DALI addresses are used
- Max system size 1x HBEAIRB-M + 1x HBEAIRB-S
- The impact protection rating of the HBEAIRB-M, HBPIR15m-M, DALI HBPIRD15m-M, KRBLT HBPIR15m-M, DALI KRBLT HBPIRD15m-M options is IK05, except when the SPORT option is used
- Max wire length from HBEAIRB-M to last HBEAIRB-S - 11 m
- Max switching load up to 2A
- Max. 15 DALI slaves
- Operating temperature range for Luminaires with EM option, °C: ta 0... +35

L30x65

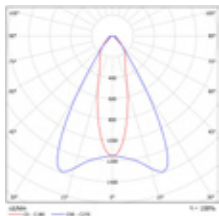

L40

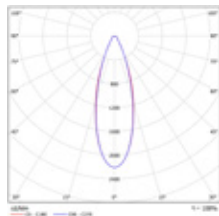

L60

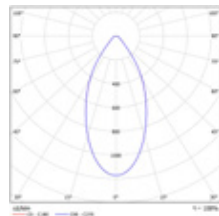

L75

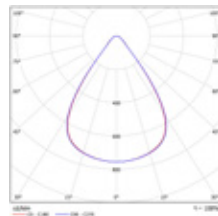

L90x90

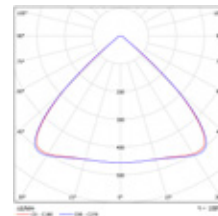

L120

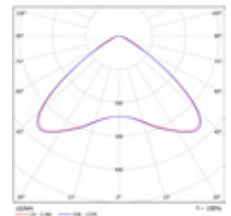

L1A50

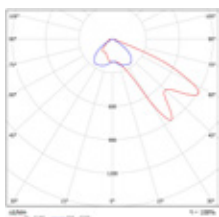

BRUBU N LED

High-bays

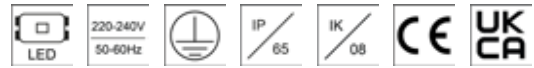

DESCRIPTION: **Recessed mounted low-bay LED luminaire**
Light distribution type: direct
Optical system: lenses, silicone rubber sealing, impact resistant
Housing: aluminium
Colour: white, RAL9003

GENERAL DATA: **Mains voltage:** 220-240V, 0/50-60Hz
LED lifetime, h: 100000/L80B10
SDCM: 3
Protection class IEC: I
Ingress protection code: IP65
Mechanical impact resistance: IK08 (HBPIR-M - IK04)
Operating temperature range, °C: ta -20...+40 (HBPIR-M ta -25...+40)

INSTALLATION: In ceiling with cut-out opening (mounting brackets included) or on the ceiling (mounting box to be ordered separately). Cable 1.0m, 3x0.75mm²

ENVIRONMENT: Outdoor with roof

APPLICATION: Fuel station

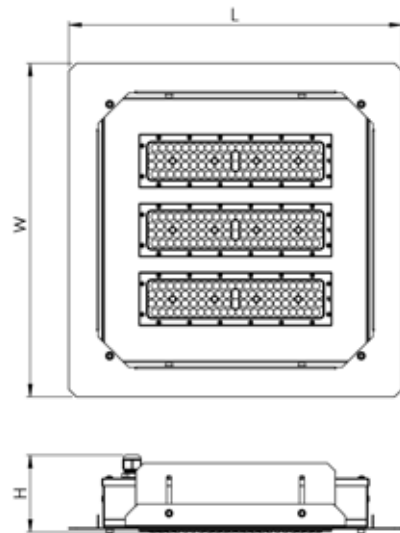

PRODUCT	LENGTH, mm	WIDTH, mm	HEIGHT, mm	CUT-OUT, mm	LUMINAIRE OUTPUT*, lm	SYSTEM POWER*, W	SYSTEM EFFICACY*, lm/W	CRI	CCT*, K	WEIGHT, kg
Brubu N LED1x9450 G350 T840 L75	435	435	85	365x365	9516	52,8	180	80+	4000	5,0
Brubu N LED1x12350 G351 T840 L75	435	435	85	365x365	12450	71,1	175	80+	4000	5,0
Brubu N LED1x15200 G352 T840 L75	435	435	85	365x365	15355	88,8	173	80+	4000	5,0

*Tolerance range for optical and electrical data: ±10%. Values apply to an ambient temperature of 25°C. NORTHCLIFFE LIGHTING is constantly developing and improving its products. The right is reserved to change any product specifications without prior notification

AVAILABLE ACCESSORIES:



Product: Power supply connector - IP66/IP68, 3x1.5mm²
Description: Quick and easy to connect power supply and luminaire cables connector - IP66/IP68, 3x1.5mm², 450V/10A, 1pcs



Product: Power supply plug - IP66/IP68, 5x1.5mm²
Description: Quick and easy to connect power supply cable plug - IP66/IP68, 5x1.5mm², 400V/16A, 1pcs



Product: Power supply socket - IP66/IP68, 5x1.5mm²
Description: Quick and easy to connect power supply cable socket - IP66/IP68, 5x1.5mm², 400V/16A, 1pcs



Product: Surface MTG BOX Brubu N LED white
Description: Surface mounting box for Brubu N LED (1pcs), white steel

OPTIONS AVAILABLE ON REQUEST:

LED	REFLECTOR AND OPTICS	CONTROL GEAR	SENSORS
T830	L30x65	DALI	HBPIR-M ¹
T840	L40	COR	
	L60	COR1min	
	L75	COR30min	
	L90x90		
	L120		

¹ This model does not have daylight harvesting function

L60

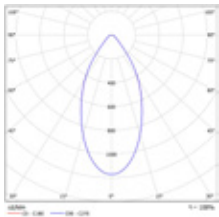

L75

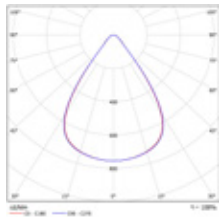

L120

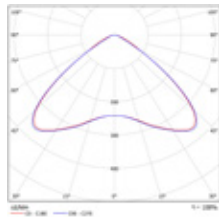

BRUBU E LED

High-bays



DESCRIPTION: **Recessed mounted low-bay LED luminaire**
Light distribution type: direct
Optical system: lenses, silicone rubber sealing, impact resistant
Housing: aluminium
Colour: white, RAL9003

GENERAL DATA: **Mains voltage:** 220-240V, 0/50-60Hz
LED lifetime, h: 100000/L80B10
SDCM: 3
Protection class IEC: I
Ingress protection code: IP65
Mechanical impact resistance: IK08
Operating temperature range, °C: ta -20...+40

INSTALLATION: In ceiling with cut-out opening. Cable 1.0m, 3x0.75mm²

ENVIRONMENT: Outdoor with roof

APPLICATION: Fuel station

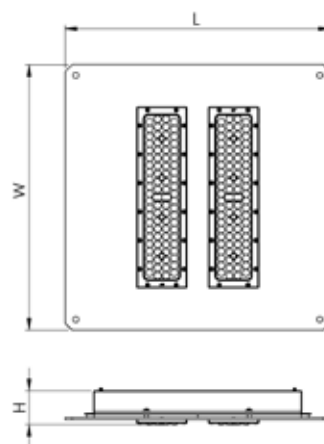

PRODUCT	LENGTH, mm	WIDTH, mm	HEIGHT, mm	CUT-OUT, mm	LUMINAIRE OUTPUT*, lm	SYSTEM POWER*, W	SYSTEM EFFICACY*, lm/W	CRI	CCT*, K	WEIGHT, kg
Brubu E LED1x10050 J679 T840 L75	370	370	52	340x270	10031	58,7	171	80+	4000	1,9
Brubu E LED1x11850 J680 T840 L75	370	370	52	340x270	11828	70,1	169	80+	4000	1,9
Brubu E LED1x13650 J681 T840 L75	370	370	52	340x270	13640	82,4	166	80+	4000	1,9

*Tolerance range for optical and electrical data: ±10%. Values apply to an ambient temperature of 25°C. NORTHCLIFFE LIGHTING is constantly developing and improving its products. The right is reserved to change any product specifications without prior notification

AVAILABLE ACCESSORIES:

 **Product:** Power supply connector - IP66/IP68, 3x1.5mm²
Description: Quick and easy to connect power supply and luminaire cables connector - IP66/IP68, 3x1.5mm², 450V/10A, 1pcs



Product: Power supply plug - IP66/IP68, 5x1.5mm²
Description: Quick and easy to connect power supply cable plug - IP66/IP68, 5x1.5mm², 400V/16A, 1pcs



Product: Power supply socket - IP66/IP68, 5x1.5mm²
Description: Quick and easy to connect power supply cable socket - IP66/IP68, 5x1.5mm², 400V/16A, 1pcs



Product: Surface MTG BOX Brubu E LED white
Description: Surface mounting box for Brubu E LED (1pcs), white steel

OPTIONS AVAILABLE ON REQUEST:

LED	REFLECTOR AND OPTICS	CONTROL GEAR
T830	L30x65	DALI
T840	L40	COR
	L60	COR1min
	L75	COR30min
	L120	

L60

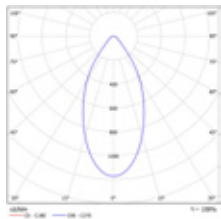

L75

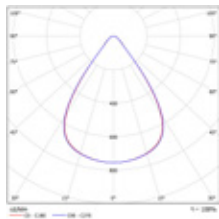

L120

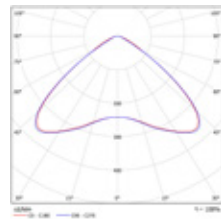

DISC LED

High-bays



DESCRIPTION: **Suspended high-bay basic LED luminaire**
Light distribution type: direct
Optical system: lens, 90°, polycarbonate, impact resistance
Housing: die-cast aluminium
Colour: black, RAL9011

GENERAL DATA: **Mains voltage:** 220-240V, 50-60Hz
LED lifetime, h: 50000/L70B50
SDCM: 5
Protection class IEC: I
Ingress protection code: IP65
Mechanical impact resistance: IK08
Operating temperature range, °C: ta -20...+40

INSTALLATION: Suspended (suspension hook included). Cable, 0.5m, 3x1.0mm²
 DALI: Two cables, 0.5m, 3x1.0mm² and 2x1.0mm²

ENVIRONMENT: Indoor

APPLICATION: Industry, warehouse, hall

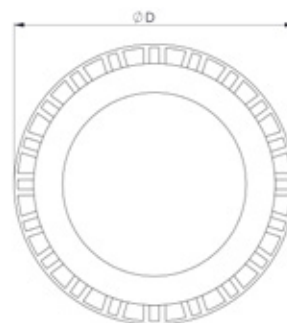

PRODUCT	DIAMETER, mm	HEIGHT, mm	LUMINAIRE OUTPUT*, lm	SYSTEM POWER*, W	SYSTEM EFFICACY*, lm/W	CRI	CCT*, K	WEIGHT, kg
Disc LED1x14000 E927 T840	290	118	15046	96,7	156	80+	4000	2,4
Disc LED1x21000 E928 T840	336	127	21589	140	151	80+	4000	2,4
Disc LED1x28000 E929 T840	376	131	28991	189,5	153	80+	4000	3,7

*Tolerance range for optical and electrical data: ±10%. Values apply to an ambient temperature of 25°C. NORTHCLIFFE LIGHTING is constantly developing and improving its products. The right is reserved to change any product specifications without prior notification

AVAILABLE ACCESSORIES:



Product: Power supply connector - IP66/IP68, 3x1.5mm²

Description: Quick and easy to connect power supply and luminaire cable connector - IP66/IP68, 3x1.5mm², 450V/10A, 1pcs



Product: Suspension MTG KIT - Saturn LED 1.5m
Description: Suspension kit for Saturn LED high-bay, 1.5 meter

Product: Suspension MTG KIT - Saturn LED 3.0m
Description: Suspension kit for Saturn LED high-bay, 3.0 meters

Product: Suspension MTG KIT - Saturn LED 5.0m
Description: Suspension kit for Saturn LED high-bay, 5.0 meters

OPTIONS AVAILABLE ON REQUEST:

CONTROL GEAR	CONNECTION
DALI ^{1 2}	CBF3x1.5-N m ³
	CBF5x1.5-N m ³

- 1 For this model DALI option is not compatible with SWITCHDIM functionality
- 2 This option comes with two tails. One for power supply, other for controls
- 3 Please specify the length of outgoing cable before placing an order

E927

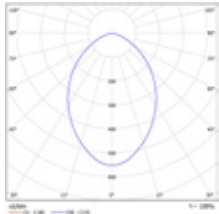

E928

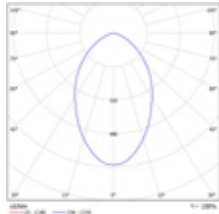

E929

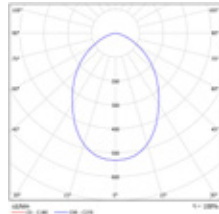

DISC A LED

High-bays

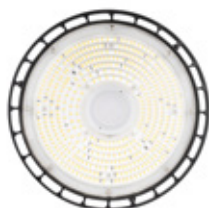

DIM ZHAGA

- DESCRIPTION:** A high-bay LED luminaire
Light distribution type: direct
Optical system: lenses, low glare
Housing: die-cast aluminium
Colour: black, RAL9017
-
- GENERAL DATA:** Mains voltage: 220-240V, 50-60Hz
LED lifetime, h: 85000/L80B10
SDCM: 5
Protection class IEC: I
Ingress protection code: IP65
Mechanical impact resistance: IK08
Operating temperature range, °C: ta -30... +50
-
- INSTALLATION:** Suspended. Supplied with suspension hook and out-going cable for easy mounting. Cable, 0.3m, 3x0.75mm²
-
- ENVIRONMENT:** Indoor
-
- APPLICATION:** Industry, warehouse, hall

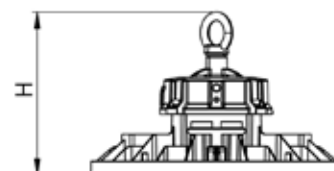
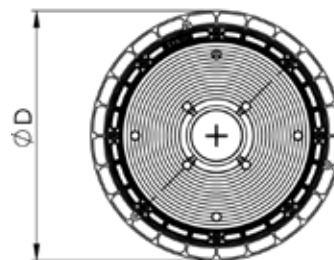

PRODUCT	DIAMETER, mm	HEIGHT, mm	LUMINAIRE OUTPUT*, lm	SYSTEM POWER*, W	SYSTEM EFFICACY*, lm/W	CRI	CCT*, K	WEIGHT, kg
DISC A LED1x18500/14800/11100 J733 T840	250	165	9650/ 13750/ 18500	60,0/80,0/ 100,0	161/172/185	80+	4000	1,6
DISC A LED1x28000/22400/16800 J734 T840	260	170	17700/ 22800/ 27750	90,0/120,0/ 150,0	196/190/185	80+	4000	1,9
DISC A LED1x37000/29600/22200 J735 T840	300	170	23600/ 30900/ 37000	120,0/160,0/ 200,0	197/193/185	80+	4000	2,3
DISC A LED1x18500/14800/11100 J733 T840 DIM ZHAGA18	250	165	9650/ 13750/ 18500	60,0/80,0/ 100	161/172/185	80+	4000	1,6
DISC A LED1x28000/22400/16800 J734 T840 DIM ZHAGA18	260	170	17700/ 22800/ 27750	90,0/120,0/ 150,0	196/190/185	80+	4000	1,9
DISC A LED1x37000/29600/22200 J735 T840 DIM ZHAGA18	300	170	23600/ 30900/ 37000	120,0/160,0/ 200,0	197/193/185	80+	4000	2,3

*Tolerance range for optical and electrical data: ±10%. Values apply to an ambient temperature of 25°C. NORTHCLIFFE LIGHTING is constantly developing and improving its products. The right is reserved to change any product specifications without prior notification

AVAILABLE ACCESSORIES:



Product: Power supply connector - IP66/IP68, 3x1.5mm²
Description: Quick and easy to connect power supply and luminaire cable connector - IP66/IP68, 3x1.5mm², 450V/10A, 1pcs



Product: Sensor ZPIR 360 D8/12 (ANT-6-ZT)
Description: Build-in PIR High-bay sensor



Product: Remote Control RC (RC-100)
Description: The functionality of the HBPIR are controlled by a number of parameters which can be changed or programmed remotely with an infrared handset RC-100



Product: Suspension MTG KIT - Saturn LED 1.5m
Description: Suspension kit for Saturn LED high-bay, 1.5 meter

Product: Suspension MTG KIT - Saturn LED 3.0m
Description: Suspension kit for Saturn LED high-bay, 3.0 meters

Product: Suspension MTG KIT - Saturn LED 5.0m
Description: Suspension kit for Saturn LED high-bay, 5.0 meters

OPTIONS AVAILABLE ON REQUEST:

CONTROL GEAR	CONNECTION
DALI	CBF3x1.5-N m ¹
	CBF5x1.5-N m ¹

¹ Please specify the length of outgoing cable before placing an order

STANDARD

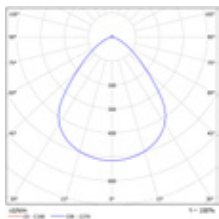

NORTHCLIFFE

making life brighter

FLOODLIGHTS



BOREAS M LED

Floodlights



DESCRIPTION: **Surface mounted LED floodlight**
Light distribution type: direct
Optical system: lenses, tempered glass diffuser, impact resistant
Housing: aluminium
Colour: dark grey, RAL7043

GENERAL DATA: **Mains voltage:** 220-240V, 0/50-60Hz
LED lifetime, h: 100000/L90B10
SDCM: 5
Protection class IEC: I
Ingress protection code: IP66
Mechanical impact resistance: IK08
Operating temperature range, °C: ta -40...+40 (J444, J445, J456 ta -25...+40/ J451 ta -40...+35)

INSTALLATION: On horizontal or vertical surface. Push-in terminal, 3x2x2.5mm²

ENVIRONMENT: Outdoor

APPLICATION: Industry, sports, facade illumination, parking area, park, public space, street

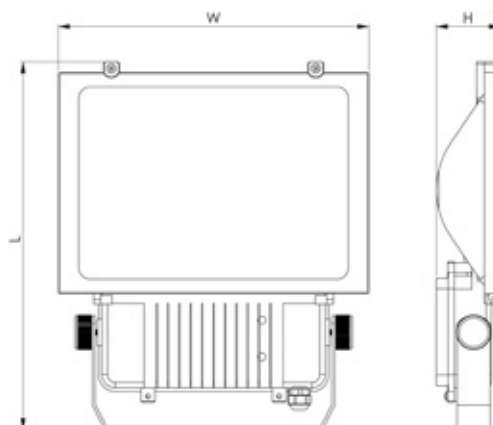

PRODUCT	LENGTH, mm	WIDTH, mm	HEIGHT, mm	LUMINAIRE OUTPUT*, lm	SYSTEM POWER*, W	SYSTEM EFFICACY*, lm/W	CRI	CCT*, K	WEIGHT, kg
Boreas M LED1x4800 J444 T740 LS90	291	230	58	4774	28,4	168	70+	4000	1,9
Boreas M LED1x8300 J445 T740 LS90	291	230	58	8279	50,5	164	70+	4000	1,9
Boreas M LED1x10250 J446 T740 LS90	291	230	58	10224	64,9	158	70+	4000	1,9
Boreas M LED1x11050 J447 T740 LS90	338	280	59	11039	67,3	164	70+	4000	2,8
Boreas M LED1x13650 J448 T740 LS90	338	280	59	13633	87,5	156	70+	4000	2,8
Boreas M LED1x16600 J449 T740 LS90	381	312	62	16558	99,8	166	70+	4000	3,6
Boreas M LED1x20450 J450 T740 LS90	381	312	62	20449	129,8	158	70+	4000	3,6
Boreas M LED1x23300 J451 T740 LS90	381	312	62	23259	152,9	152	70+	4000	3,6
Boreas M LED1x20700 J452 T740 LS90	444	353	66	20698	124,8	166	70+	4000	5,0
Boreas M LED1x25600 J453 T740 LS90	444	353	66	25561	162,3	157	70+	4000	5,0
Boreas M LED1x33150 J454 T740 LS90	515	420	87	33116	197,6	168	70+	4000	7,6
Boreas M LED1x38800 G982 T740 LS90	565	460	100	38774	235,4	165	70+	4000	10,5
Boreas M LED1x43150 G983 T740 LS90	565	460	100	43126	270,1	160	70+	4000	10,5
Boreas M LED1x50700 G984 T740 LS90	565	460	100	50687	321,6	158	70+	4000	10,5

*Tolerance range for optical and electrical data: ±10%. Values apply to an ambient temperature of 25°C. NORTHCLIFFE LIGHTING is constantly developing and improving its products. The right is reserved to change any product specifications without prior notification

AVAILABLE ACCESSORIES:



Product: Power supply connector - IP66/IP68, 3x1.5mm²
Description: Quick and easy to connect power supply and luminaire cable connector - IP66/IP68, 3x1.5mm², 450V/10A, 1pcs



Product: Power supply plug - IP66/IP68, 5x1.5mm²
Description: Quick and easy to connect power supply cable plug - IP66/IP68, 5x1.5mm², 400V/16A, 1pcs



Product: Power supply socket - IP66/IP68, 5x1.5mm²
Description: Quick and easy to connect power supply cable socket - IP66/IP68, 5x1.5mm², 400V/16A, 1pcs

OPTIONS AVAILABLE ON REQUEST:

LED	REFLECTOR AND OPTICS	CONTROL GEAR	CONNECTION	COLOUR
T730 ¹	LS20	DALI ²	CBF3x1.5-N m ³	RAL
T740 ¹	LS30	ADIM	CBF5x1.5-N m ³	
T750 ¹	LS45			
	LS60			
	LS90			
	LSA1			
	LSA2			
	LSM1			
	LSM2			
	LSS1			
	LSS2			

- 1 For models: G982...G984 only T740 option is available
- 2 For models: G982...G984 DALI option is not applicable
- 3 Please specify the length of outgoing cable before placing an order

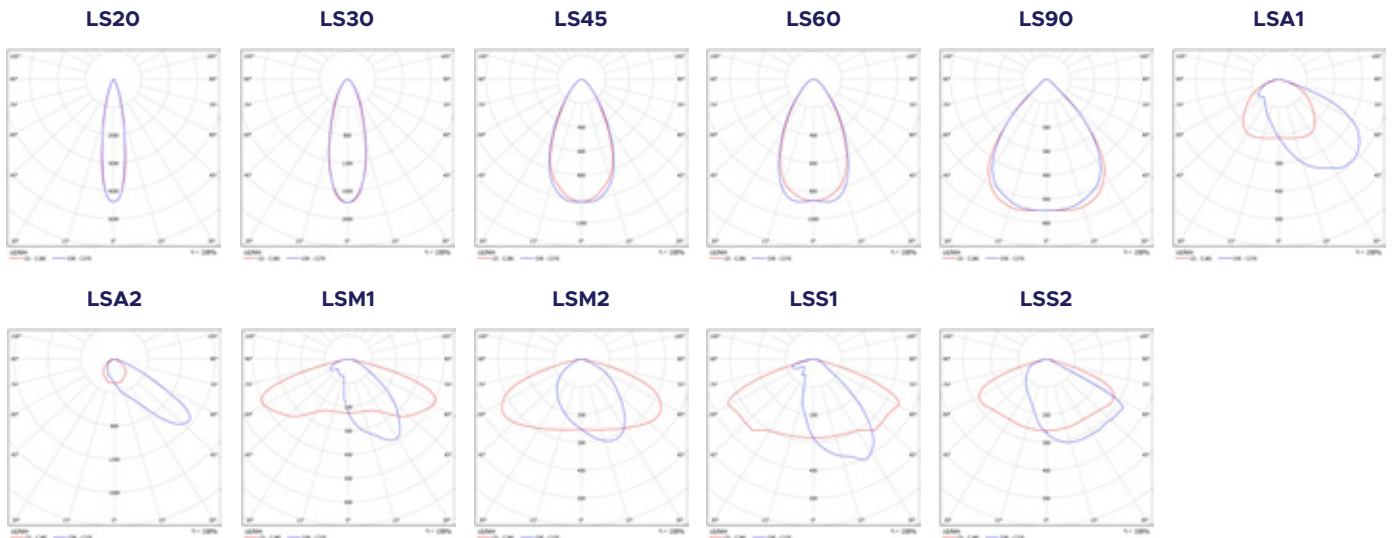

BETA LED

Floodlights



DESCRIPTION: **Surface mounted basic LED floodlight**
Light distribution type: direct
Optical system: white thermoplastic reflector, symmetric, tempered glass diffuser
Housing: die-cast aluminium
Colour: dark grey, RAL7043

GENERAL DATA: **Mains voltage:** 220-240V, 50-60Hz
LED lifetime, h: 25000/L70B50
SDCM: 5
Protection class IEC: I
Ingress protection code: IP65
Mechanical impact resistance: IK04
Operating temperature range, °C: ta -20...+40

INSTALLATION: On the horizontal or vertical surface. Cable, 0.3m, 3x1.00mm²

ENVIRONMENT: Outdoor

APPLICATION: Facade illumination, parking area, park, public space

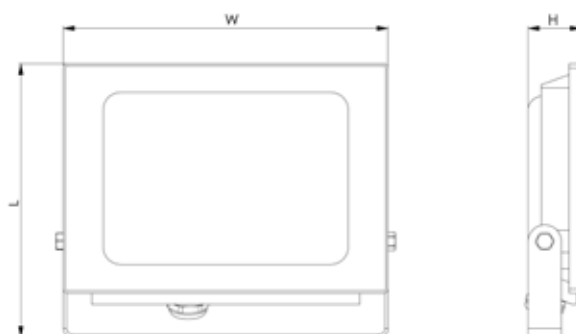

PRODUCT	LENGTH, mm	WIDTH, mm	HEIGHT, mm	LUMINAIRE OUTPUT*, lm	SYSTEM POWER*, W	SYSTEM EFFICACY*, lm/W	CRI	CCT*, K	WEIGHT, kg
Beta LED1x2700 E923 T740	157	126	25	2700	30,0	90	70+	4000	0,4
Beta LED1x4500 E924 T740	208	170	36	4500	50,0	90	70+	4000	0,9
Beta LED1x9000 E925 T740	320	250	42	9000	100,0	90	70+	4000	1,9
Beta LED1x18000 E926 T740	418	334	43	18000	200,0	90	70+	4000	3,7

*Tolerance range for optical and electrical data: ±10%. Values apply to an ambient temperature of 25°C. NORTHCLIFFE LIGHTING is constantly developing and improving its products. The right is reserved to change any product specifications without prior notification

AVAILABLE ACCESSORIES:



Product: Power supply connector - IP66/IP68, 3x1.5mm²
Description: Quick and easy to connect power supply and luminaire cable connector - IP66/IP68, 3x1.5mm², 450V/10A, 1pcs

STANDARD

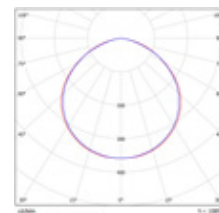

TAKU LED

Floodlights



DESCRIPTION: Surface mounted high-power LED floodlight
Light distribution type: direct
Optical system: lenses, tempered glass diffuser, impact resistant
Housing: aluminium
Colour: dark grey, RAL7043

GENERAL DATA: Mains voltage: 220-240V, 50-60Hz
LED lifetime, h: 135000/L80B10
SDCM: 3
Protection class IEC: I
Ingress protection code: IP66
Mechanical impact resistance: IK08
Operating temperature range, °C: ta -40...+40 (LED1x)/ ta -40...+50 (LED2x; LED3x)

INSTALLATION: On the horizontal or vertical surface. Screw terminal, 3x1x2.5mm²

ENVIRONMENT: Outdoor

APPLICATION: Industry, sports, transport terminal, airport

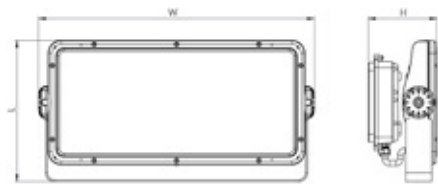

1x DALI models comes with separate gearbox

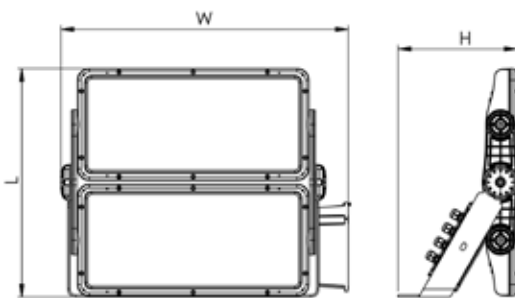

2x models comes with separate gearbox

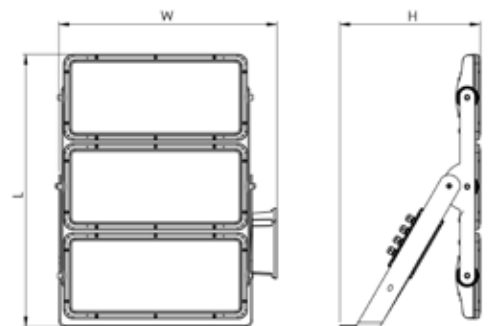
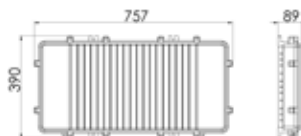

3x models comes with separate gearbox



PRODUCT	LENGTH, mm	WIDTH, mm	HEIGHT, mm	LUMINAIRE OUTPUT*, lm	SYSTEM POWER*, W	SYSTEM EFFICACY*, lm/W	CRI	CCT*, K	WEIGHT, kg
Taku LED1x50400 E950 T740 LS90	320	640	165	50377	335,5	150	70+	4000	15,7
Taku LED1x56500 E951 T740 LS90	320	640	165	56500	383,0	148	70+	4000	15,7
Taku LED1x68600 E952 T740 LS90	320	640	165	68582	488,3	140	70+	4000	15,7
Taku LED2x50400 E953 T740 LS90	580	750	300	100753	671,0	150	70+	4000	34,5
Taku LED2x56500 E954 T740 LS90	580	750	300	113000	766,0	148	70+	4000	34,5
Taku LED2x68600 E955 T740 LS90	580	750	300	137164	976,6	140	70+	4000	34,5
Taku LED3x50400 J835 T740 LS90	637	464	900	151130	1006,5	150	70+	4000	41,5
Taku LED3x56500 J836 T740 LS90	637	464	900	169501	1148,9	150	70+	4000	41,5
Taku LED3x68600 J837 T740 LS90	637	464	900	205745	1464,9	150	70+	4000	41,5

*Tolerance range for optical and electrical data: ±10%. Values apply to an ambient temperature of 25°C. NORTHCLIFFE LIGHTING is constantly developing and improving its products. The right is reserved to change any product specifications without prior notification

OPTIONS AVAILABLE ON REQUEST:

REFLECTOR AND OPTICS	CONTROL GEAR	PROTECTION
LS30	DALI ¹	10KV
LS45		
LS60		
LS90		
LSA1		
LSA2		
LSM1		

¹ With DALI option LED1x versions are also produced with a separate gearbox

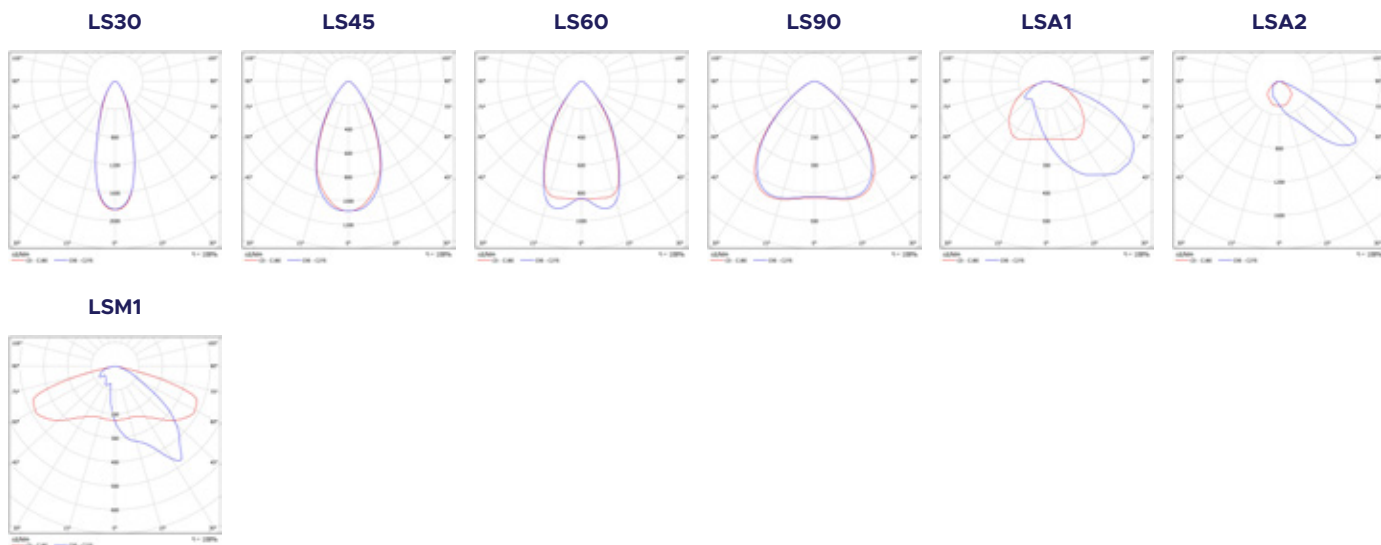



OUTDOOR ACCENT LIGHTING



GRUS LED

Outdoor Accent Lighting



DESCRIPTION: **Surface mounted accent LED luminaire**
Light distribution type: direct
Optical system: lenses, tempered glass diffuser, impact resistant
Housing: aluminium
Colour: dark grey, RAL7043

GENERAL DATA: **Mains voltage:** 220-240V, 50-60Hz
LED lifetime, h: 50000/L70B50
SDCM: 5
Protection class IEC: I
Ingress protection code: IP65
Mechanical impact resistance: IK08
Operating temperature range, °C: ta -25...+40

INSTALLATION: On the horizontal or vertical surface. Push-in terminal, 3x2x2.5mm² (for C313, 314 Cable, 0.3m, 3x0.75mm²)

ENVIRONMENT: Outdoor

APPLICATION: Facade illumination, public space

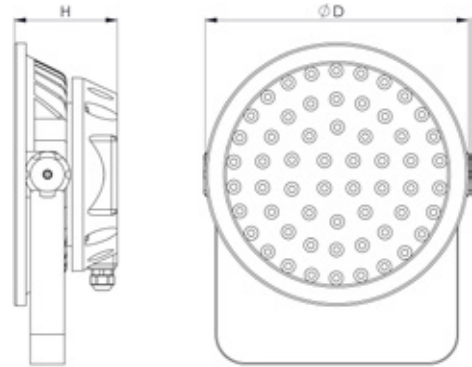

PRODUCT	DIAMETER, mm	HEIGHT, mm	LUMINAIRE OUTPUT*, lm	SYSTEM POWER*, W	SYSTEM EFFICACY*, lm/W	CRI	CCT*, K	WEIGHT, kg
Grus S LED1x1100 C313 T740 L30	120	90	1061	8,2	129	70+	4000	0,9
Grus S LED1x1500 C314 T740 L30	120	90	1484	10,7	139	70+	4000	0,9
Grus M LED1x4950 C399 T740 L30	230	118	4914	30,1	163	70+	4000	3,7
Grus M LED1x7200 C400 T740 L30	230	118	7193	46,6	154	70+	4000	3,7
Grus M LED1x8100 C401 T740 L30	230	118	8072	53,7	150	70+	4000	3,7
Grus B LED1x12500 C413 T740 L30	310	137	12459	78,9	158	70+	4000	6,5
Grus B LED1x16150 C414 T740 L30	310	137	16145	107,3	150	70+	4000	6,5
Grus B LED1x18600 C415 T740 L30	310	137	18577	127,2	146	70+	4000	6,5

*Tolerance range for optical and electrical data: ±10%. Values apply to an ambient temperature of 25°C. NORTHCLIFFE LIGHTING is constantly developing and improving its products. The right is reserved to change any product specifications without prior notification

AVAILABLE ACCESSORIES:



Product: Grus M LED Louver D230
Description: Grus M LED louver for better glare control

Product: Grus B LED Louver D310
Description: Grus B LED louver for better glare control

OPTIONS AVAILABLE ON REQUEST:

LED	REFLECTOR AND OPTICS	CONTROL GEAR	CONNECTION
T730 ¹	L10	DALI ²	CBF3x1.5-N m ³
T740	L15		CBF5x1.5-N m ³
	L15x38		
	L30		
	L50		

¹ T730 option not applicable for models: C413, C414, C415

² DALI option not applicable for models: C313; C314

³ Please specify the length of outgoing cable before placing an order. CBF3x1.5-N m and CBF5x1.5-N m options are standard for models: C313, C314

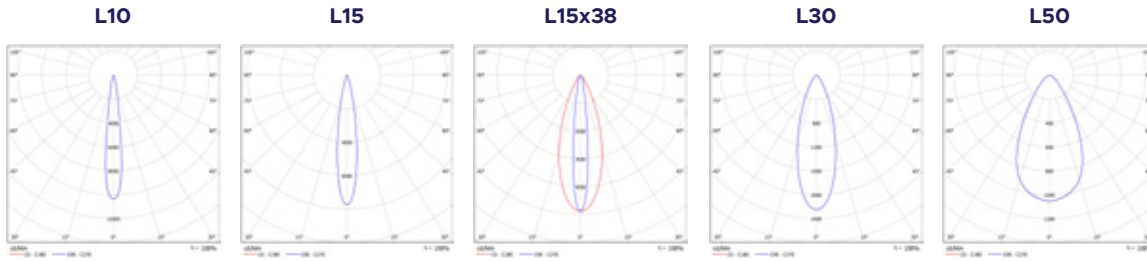

CYGNI LED

Outdoor Accent Lighting



DESCRIPTION: **Surface mounted accent LED luminaire**
Light distribution type: direct
Optical system: lenses, 30°, tempered glass diffuser, impact resistant
Housing: aluminium
Colour: light grey

GENERAL DATA: **Mains voltage:** 220-240V, 50-60Hz
LED lifetime, h: 50000/L80B50
SDCM: 3
Protection class IEC: I
Ingress protection code: IP66
Mechanical impact resistance: IK09
Operating temperature range, °C: ta -25...+40

INSTALLATION: On the horizontal or vertical surface (mounting bracket included). Cable, 1.0m, 3x1.5mm²

ENVIRONMENT: Outdoor

APPLICATION: Facade illumination



PRODUCT	LENGTH, mm	WIDTH, mm	HEIGHT, mm	LUMINAIRE OUTPUT*, lm	SYSTEM POWER*, W	SYSTEM EFFICACY*, lm/W	CRI	CCT*, K	WEIGHT, kg
Cygni LED1x1900 D775 T740 L30	705	82	164	1897	15,8	120	80+	4000	3,0
Cygni LED1x2400 D776 T740 L30	705	82	164	2370	22,6	105	80+	4000	3,0
Cygni LED1x3200 D777 T740 L30	705	82	164	3162	29,9	106	80+	4000	3,0
Cygni LED1x3800 D778 T740 L30	1265	82	164	3794	29,9	127	80+	4000	6,0
Cygni LED1x4800 D779 T740 L30	1265	82	164	4740	42,7	111	80+	4000	6,0
Cygni LED1x6400 D780 T740 L30	1265	82	164	6324	59,7	106	80+	4000	6,0

*Tolerance range for optical and electrical data: ±10%. Values apply to an ambient temperature of 25°C. NORTHCLIFFE LIGHTING is constantly developing and improving its products. The right is reserved to change any product specifications without prior notification

AVAILABLE ACCESSORIES:



Product: Power supply connector - IP66/IP68, 3x1.5mm²

Description: Quick and easy to connect power supply and luminaire cable connector - IP66/IP68, 3x1.5mm², 450V/10A, 1pcs

OPTIONS AVAILABLE ON REQUEST:

LED	CONTROL GEAR	CONNECTION
T730	DALI	1LIN 2xCBF3x0.3m
T740		

STANDARD

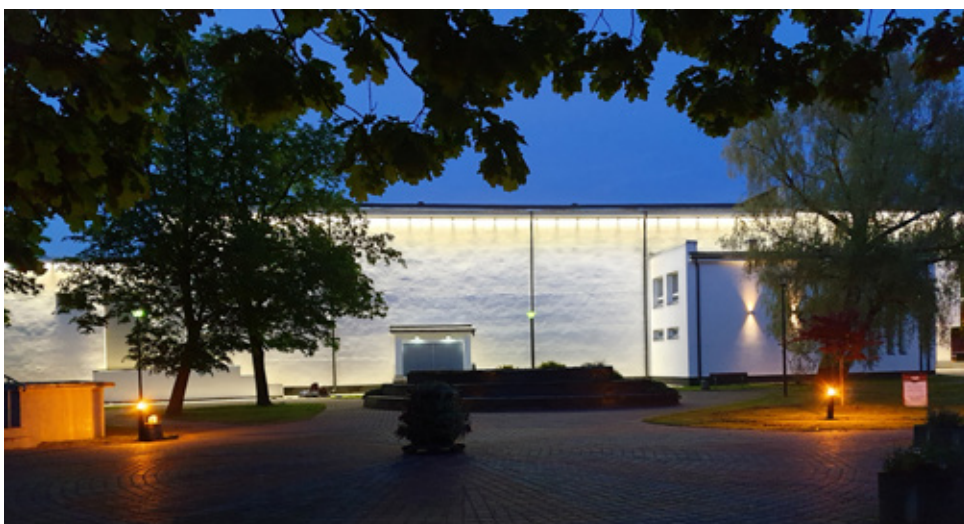
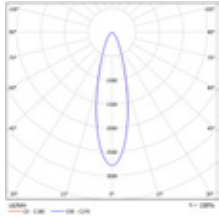

BULL S LED

Outdoor Accent Lighting



DESCRIPTION: **Wall-mounted accent LED luminaire**
Light distribution type: direct
Optical system: lenses, tempered glass diffuser
Housing: aluminium
Colour: grey, RAL9023

GENERAL DATA: **Mains voltage:** 220-240V, 50-60Hz
LED lifetime, h: 50000/L80B50
SDCM: 5
Protection class IEC: I
Ingress protection code: IP66
Mechanical impact resistance: IK08
Operating temperature range, °C: ta -25..+40

INSTALLATION: On the horizontal or vertical surface. Cable, 0.5m, 3x1.0mm²

ENVIRONMENT: Outdoor

APPLICATION: Facade illumination

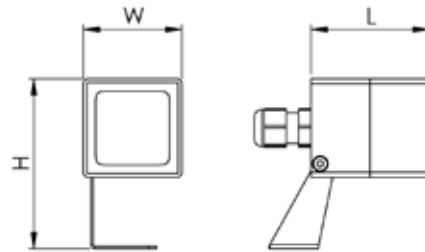

PRODUCT	LENGTH, mm	WIDTH, mm	HEIGHT, mm	LUMINAIRE OUTPUT*, lm	SYSTEM POWER*, W	SYSTEM EFFICACY*, lm/W	CRI	CCT*, K	WEIGHT, kg
Bull S LED1x500 J782 T840 L30	48	40	69	500	6,0	83	80+	4000	0,3

*Tolerance range for optical and electrical data: ±10%. Values apply to an ambient temperature of 25°C. NORTHCLIFFE LIGHTING is constantly developing and improving its products. The right is reserved to change any product specifications without prior notification

AVAILABLE ACCESSORIES:



Product: Spike - Bull S LED
Description: Ground spike

OPTIONS AVAILABLE ON REQUEST:

LED	REFLECTOR AND OPTICS
T830	L8
T840	L12
	L30
	L10x60

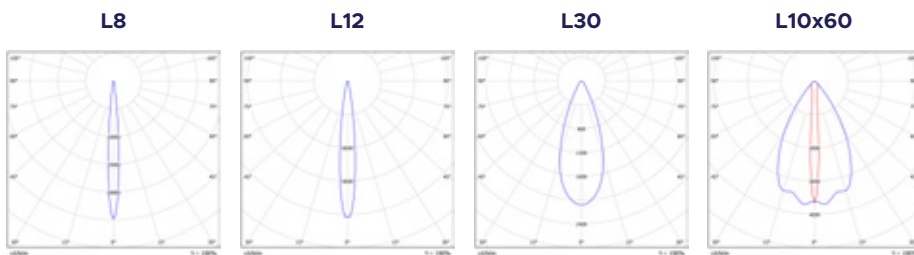





BULL M LED

Outdoor Accent Lighting

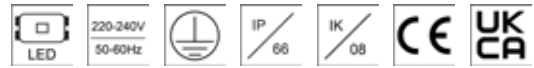

DESCRIPTION: **Wall-mounted accent LED luminaire**
Light distribution type: direct
Optical system: lenses, tempered glass diffuser
Housing: aluminium
Colour: grey, RAL9023

GENERAL DATA: **Mains voltage:** 220-240V, 50-60Hz
LED lifetime, h: 50000/L80B50
SDCM: 5
Protection class IEC: I
Ingress protection code: IP66
Mechanical impact resistance: IK08
Operating temperature range, °C: ta -25...+40

INSTALLATION: On the horizontal or vertical surface. Cable, 0.5m, 3x1.0mm²

ENVIRONMENT: Outdoor

APPLICATION: Facade illumination

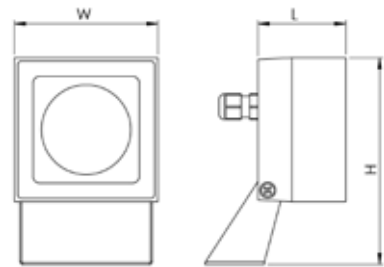

PRODUCT	LENGTH, mm	WIDTH, mm	HEIGHT, mm	LUMINAIRE OUTPUT*, lm	SYSTEM POWER*, W	SYSTEM EFFICACY*, lm/W	CRI	CCT*, K	WEIGHT, kg
Bull M LED1x850 J783 T840 L30	52	85	122	832	10,0	83	80+	4000	0,7

*Tolerance range for optical and electrical data: ±10%. Values apply to an ambient temperature of 25°C. NORTHCLIFFE LIGHTING is constantly developing and improving its products. The right is reserved to change any product specifications without prior notification

AVAILABLE ACCESSORIES:



Product: Spike - Bull M LED
Description: Ground spike

OPTIONS AVAILABLE ON REQUEST:

LED	REFLECTOR AND OPTICS
T830	L2
T840	L8
	L12
	L30
	L10x70

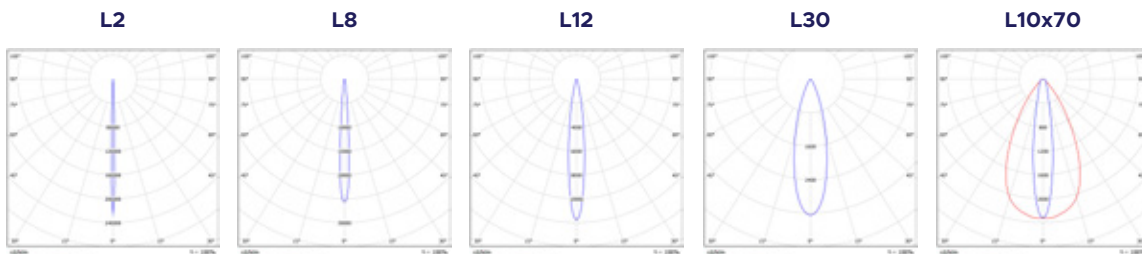

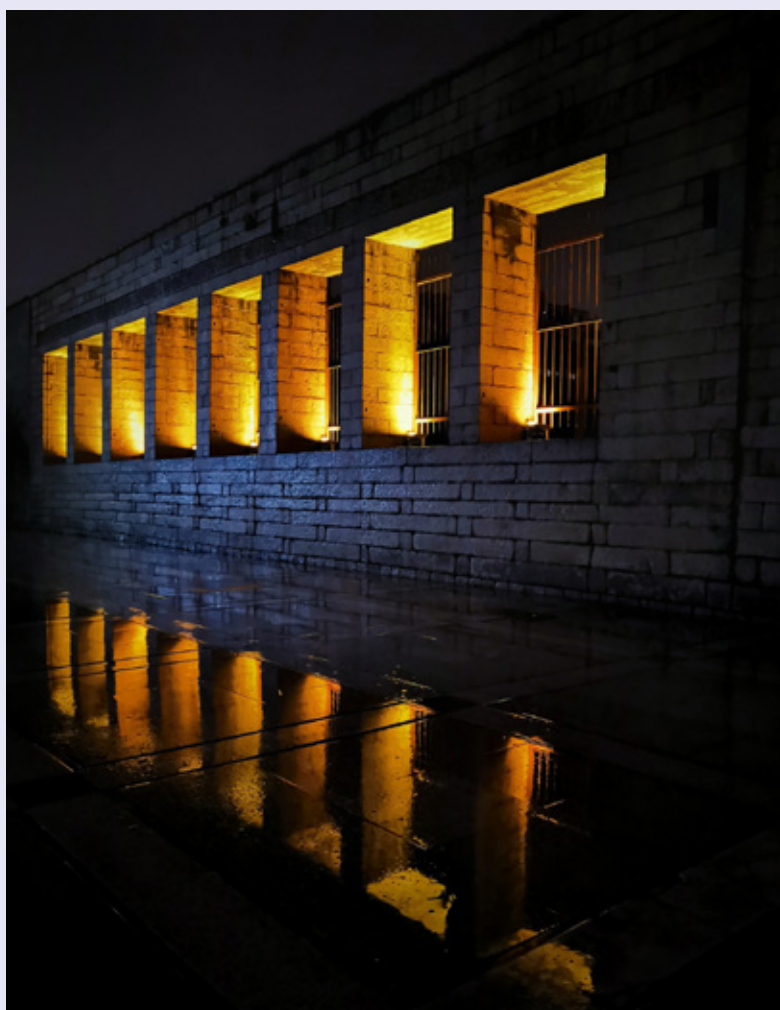

COMET S LED

Outdoor Accent Lighting



DESCRIPTION: **Wall-mounted accent LED luminaire**
Light distribution type: direct
Optical system: lenses, tempered glass diffuser
Housing: aluminium
Colour: grey, RAL9023

GENERAL DATA: **Mains voltage:** 220-240V, 50-60Hz
LED lifetime, h: 50000/L80B50
SDCM: 5
Protection class IEC: I
Ingress protection code: IP66
Mechanical impact resistance: IK08
Operating temperature range, °C: ta -25...+40

INSTALLATION: On the horizontal or vertical surface. Cable, 0.5m, 3x1.0mm²

ENVIRONMENT: Outdoor

APPLICATION: Facade illumination

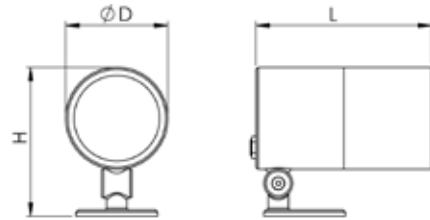

PRODUCT	LENGTH, mm	DIAMETER, mm	HEIGHT, mm	LUMINAIRE OUTPUT*, lm	SYSTEM POWER*, W	SYSTEM EFFICACY*, lm/W	CRI	CCT*, K	WEIGHT, kg
Comet S LED1x850 J784 T840 L30	86	50	81	832	10,0	83	80+	4000	0,4

*Tolerance range for optical and electrical data: ±10%. Values apply to an ambient temperature of 25°C. NORTHCLIFFE LIGHTING is constantly developing and improving its products. The right is reserved to change any product specifications without prior notification

AVAILABLE ACCESSORIES:



Product: Spike - Comet S LED
Description: Ground spike

OPTIONS AVAILABLE ON REQUEST:

LED	REFLECTOR AND OPTICS
T830	L2
T840	L6
	L12
	L30
	L10x70

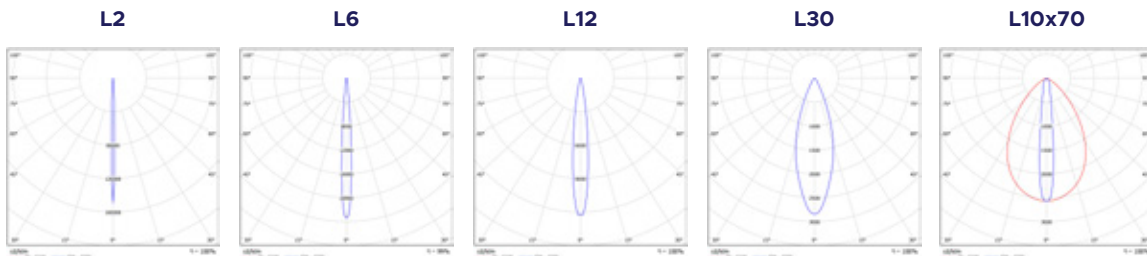



AUSTRU D LED

Outdoor Accent Lighting

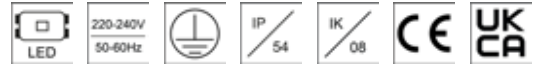

DESCRIPTION: Surface mounted accent LED luminaire
Light distribution type: direct
Optical system: lenses, 2x60°, tempered glass diffuser, impact resistant
Housing: aluminium
Colour: dark grey, RAL7043

GENERAL DATA: Mains voltage: 220-240V, 50-60Hz
 LED lifetime, h: 40000/L70B50
 SDCM: 5
 Protection class IEC: I
 Ingress protection code: IP54
 Mechanical impact resistance: IK08
 Operating temperature range, °C: ta -25..+40

INSTALLATION: On the wall. Screw terminal, 3x1x1.5mm²

ENVIRONMENT: Outdoor

APPLICATION: Facade illumination

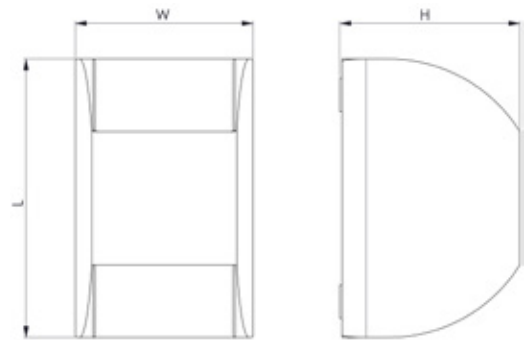

PRODUCT	LENGTH, mm	WIDTH, mm	HEIGHT, mm	LUMINAIRE OUTPUT*, lm	SYSTEM POWER*, W	SYSTEM EFFICACY*, lm/W	CRI	CCT*, K	WEIGHT, kg
Austru D LED1x600 C406 T840	125	90	80	510	6,7	77	80+	4000	0,6

*Tolerance range for optical and electrical data: ±10%. Values apply to an ambient temperature of 25°C. NORTHCLIFFE LIGHTING is constantly developing and improving its products. The right is reserved to change any product specifications without prior notification

STANDARD

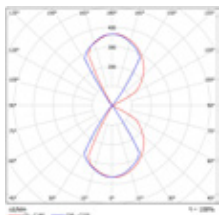

RAY LED

Outdoor Accent Lighting



L15

DESCRIPTION: **Surface mounted accent LED luminaire**
Light distribution type: direct/indirect
Optical system: lenses, tempered glass diffuser
Housing: aluminium
Colour: dark grey, RAL7043

GENERAL DATA: **Mains voltage:** 220-240V, 50-60Hz
LED lifetime, h: 50000/L80B50
SDCM: 5
Protection class IEC: I
Ingress protection code: IP65
Mechanical impact resistance: IK08
Operating temperature range, °C: ta -30...+45

INSTALLATION: On the wall. Screw terminal, 3x1x2.5mm²

ENVIRONMENT: Outdoor

APPLICATION: Facade illumination



PRODUCT	LENGTH, mm	WIDTH, mm	HEIGHT, mm	LUMINAIRE OUTPUT*, lm	SYSTEM POWER*, W	SYSTEM EFFICACY*, lm/W	CRI	CCT*, K	WEIGHT, kg
Ray LED2x400 J787 T840	137	55	162	800	12,5	64	80+	4000	0,8
Ray LED2x550 J787 T840 L15	137	55	162	1050	10,5	100	80+	4000	0,8

*Tolerance range for optical and electrical data: ±10%. Values apply to an ambient temperature of 25°C. NORTHCLIFFE LIGHTING is constantly developing and improving its products. The right is reserved to change any product specifications without prior notification

OPTIONS AVAILABLE ON REQUEST:

LED
T830
T840

2x

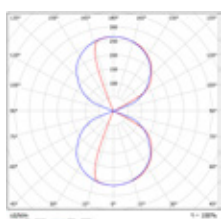

2x L15

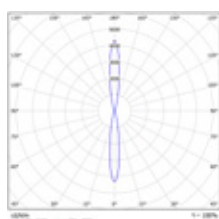

TUBE M LED

Outdoor Accent Lighting



Tube M LED



Tube M UP LED



Tube M SR LED

DESCRIPTION: Surface mounted LED wall washer / Surface mounted accent LED luminaire
Light distribution type: direct
Optical system: lenses, tempered glass diffuser, impact resistant
Housing: aluminium
Colour: dark grey, RAL7043

GENERAL DATA: Mains voltage: 220-240V, 50-60Hz
 LED lifetime, h: 60000/L80B10
 SDCM: 3
 Protection class IEC: I
 Ingress protection code: IP65
 Mechanical impact resistance: IK08
 Operating temperature range, °C: ta -25...+40

INSTALLATION: On the wall or ceiling. Screw terminal, 3x1x1.5mm²

ENVIRONMENT: Outdoor

APPLICATION: Facade illumination

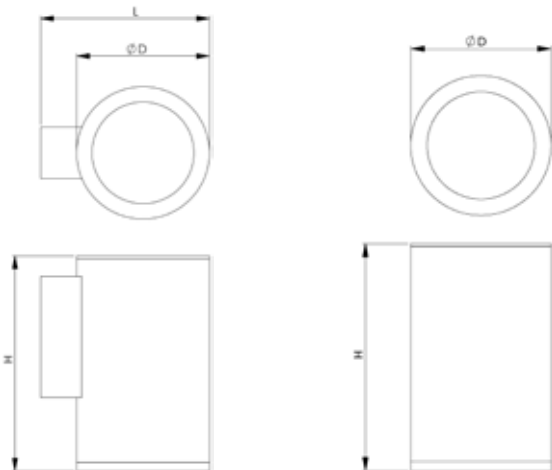

PRODUCT	LENGTH, mm	DIAMETER, mm	HEIGHT, mm	LUMINAIRE OUTPUT*, lm	SYSTEM POWER*, W	SYSTEM EFFICACY*, lm/W	CRI	CCT*, K	WEIGHT kg
Wall-mounted luminaires with up and down light distribution									
Tube M LED2x1100 D042 T840 L30	200	155	464	2115	19,3	110	80+	4000	3,2
Tube M LED2x1500 D043 T840 L30	200	155	464	2901	26,0	112	80+	4000	3,2
Tube M LED2x2000 D044 T840 L30	200	155	464	4026	38,4	105	80+	4000	3,2
Wall-mounted luminaires with up (or down) light distribution									
Tube M UP LED1x1100 D045 T840 L30	200	155	250	1058	9,6	110	80+	4000	2,2
Tube M UP LED1x1500 D046 T840 L30	200	155	250	1451	13,1	110	80+	4000	2,2
Tube M UP LED1x2000 D047 T840 L30	200	155	250	2013	19,4	104	80+	4000	2,2
Ceiling-mounted luminaires with down light distribution									
Tube M SR LED1x1100 D048 T840 L30		155	250	1058	9,6	110	80+	4000	2,2
Tube M SR LED1x1500 D049 T840 L30		155	250	1451	13,1	110	80+	4000	2,2
Tube M SR LED1x2000 D050 T840 L30		155	250	2013	19,4	104	80+	4000	2,2

*Tolerance range for optical and electrical data: ±10%. Values apply to an ambient temperature of 25°C. NORTHCLIFFE LIGHTING is constantly developing and improving its products. The right is reserved to change any product specifications without prior notification

OPTIONS AVAILABLE ON REQUEST:

LED	REFLECTOR AND OPTICS
T830	L30
T840	L45
	L60

2x L30

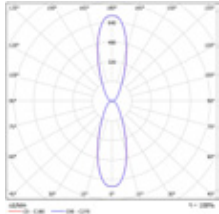

2x L45

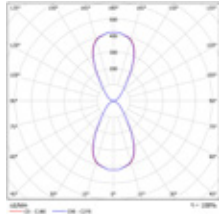

2x L60

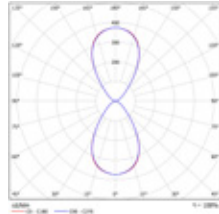

UP L30

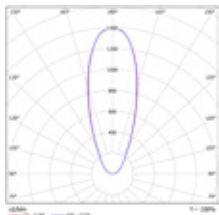

UP L45

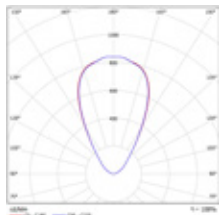

UP L60

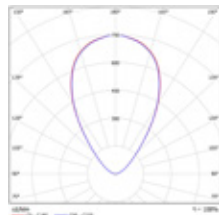

SR L30

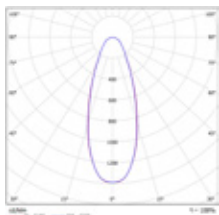

SR L45

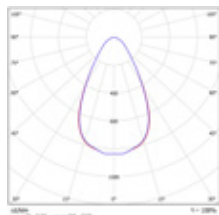

SR L60

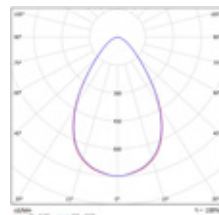



TUBE S LED

Outdoor Accent Lighting

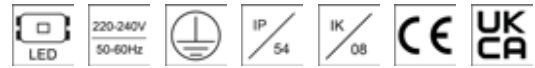

DESCRIPTION: **Surface mounted LED wall washer**
Light distribution type: direct/indirect
Optical system: tempered glass diffuser, impact resistant
Housing: aluminium
Colour: dark grey, RAL7043

GENERAL DATA: **Mains voltage:** 220-240V, 50-60Hz
LED lifetime, h: 15000/L70B50
Protection class IEC: I
Ingress protection code: IP54
Mechanical impact resistance: IK08
Operating temperature range, °C: ta -25...+40

INSTALLATION: On the wall. Screw terminal, 3x1x1.5mm²

ENVIRONMENT: Outdoor

APPLICATION: Facade illumination



PRODUCT	LENGTH, mm	DIAMETER, mm	HEIGHT, mm	LUMINAIRE OUTPUT*, lm	SYSTEM POWER*, W	SYSTEM EFFICACY*, lm/W	CRI	CCT*, K	WEIGHT, kg
Tube S 2GU10 O13	160	90	300						1,4
Tube S 1GU10 O14 UP	160	90	158						1,3
Tube S 1GU10 O15 DOWN	160	90	158						1,3
Tube S LED2x400 G865 T840 L40	160	90	300	794	8,4	95	80+	4000	1,5
Tube S UP LED1x400 G866 T840 L40	160	90	158	397	4,2	95	80+	4000	1,4

*Tolerance range for optical and electrical data: ±10%. Values apply to an ambient temperature of 25°C. NORTHCLIFFE LIGHTING is constantly developing and improving its products. The right is reserved to change any product specifications without prior notification

OPTIONS AVAILABLE ON REQUEST:

LED	COLOUR
T830	RAL
T840	

2x L40

UP L40

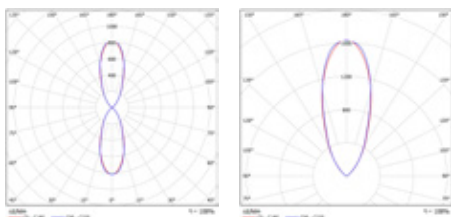

PIPE LED

Outdoor Accent Lighting



L15



R36



SR R60



SR R90

DESCRIPTION: **Wall-mounted accent LED luminaire / Surface mounted accent LED luminaire**
Light distribution type: direct/indirect or direct
Optical system: reflectors or lenses, tempered glass diffuser
Housing: aluminium
Colour: dark grey, RAL7043

GENERAL DATA: **Mains voltage:** 220-240V, 50-60Hz
LED lifetime, h: 50000/L80B50
SDCM: 5
Protection class IEC: I
Ingress protection code: IP65
Mechanical impact resistance: IK08
Operating temperature range, °C: ta -30...+45

INSTALLATION: On the wall. Screw terminal, 3x1x2.5mm² / On the ceiling. Cable, 0.15m, 3x1.0mm²

ENVIRONMENT: Outdoor

APPLICATION: Facade illumination / Facade illumination, parking area, public space

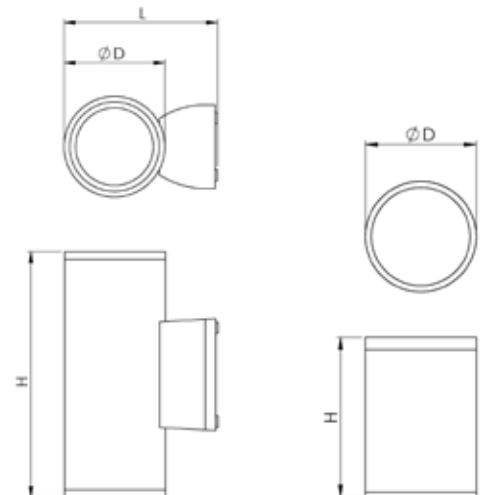

PRODUCT	LENGTH, mm	DIAMETER, mm	HEIGHT, mm	LUMINAIRE OUTPUT*, lm	SYSTEM POWER*, W	SYSTEM EFFICIACY*, lm/W	CRI	CCT*, K	WEIGHT*, kg
Wall-mounted luminaires with up and down light distribution									
Pipe LED2x650 J789 T840 R36	132	90	220	1250	12,5	100	80+	4000	1,1
Pipe LED2x1100 J790 T840 R36	156	108	260	2160	27,0	80	80+	4000	1,6
Pipe LED2x650 J791 T840 L15	132	90	130	1288	12,5	103	80+	4000	0,9
Pipe LED2x750 J792 T840 L15	156	108	160	1490	17,0	88	80+	4000	1,5
Wall-mounted luminaires with up (or down) light distribution									
Pipe UP LED1x700 J793 T840 R36	132	90	220	680	8,5	80	80+	4000	0,9
Pipe UP LED1x1100 J794 T840 R36	156	108	260	1064	12,5	85	80+	4000	1,2
Pipe UP LED1x650 J795 T840 L15	132	90	130	650	6,5	100	80+	4000	0,8
Pipe UP LED1x800 J796 T840 L15	156	108	160	791	8,5	93	80+	4000	1,1
Ceiling-mounted luminaires with down light distribution									
Pipe SR LED1x550 J797 T840 R60	90	90	113	520	6,5	80	80+	4000	0,6
Pipe SR LED1x700 J798 T840 R60	108	108	150	680	8,5	80	80+	4000	0,9
Pipe SR LED1x1100 J799 T840 R90	145	145	120	1100	12,5	88	80+	4000	1,4
Pipe SR LED1x1150 J845 T840 R60	90	90	180	1136	12,5	91	80+	4000	0,8

*Tolerance range for optical and electrical data: ±10%. Values apply to an ambient temperature of 25°C. NORTHCLIFFE LIGHTING is constantly developing and improving its products. The right is reserved to change any product specifications without prior notification

OPTIONS AVAILABLE ON REQUEST:

LED	REFLECTOR AND OPTICS
T830	R36 ¹
T840	R60 ¹

¹ Option is only available for models: J789; J790; J793; J794

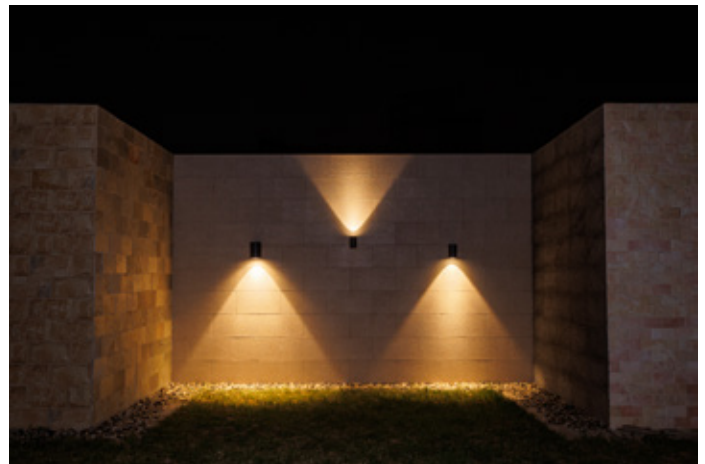
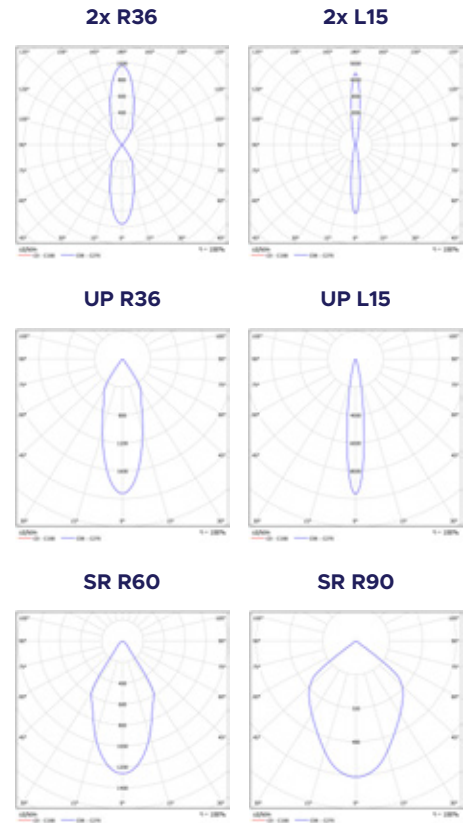

CUBE LED

Outdoor Accent Lighting



L15



R36



SR R60



SR R90

DESCRIPTION:

Architectural LED wall washer / Surface mounted accent LED luminaire
Light distribution type: direct/indirect or direct
Optical system: reflectors or lenses, tempered glass diffuser
Housing: aluminium
Colour: dark grey, RAL7043

GENERAL DATA:

Mains voltage: 220-240V, 50-60Hz
LED lifetime, h: 50000/L80B50
SDCM: 5
Protection class IEC: I
Ingress protection code: IP65
Mechanical impact resistance: IK08
Operating temperature range, °C: ta -30...+45

INSTALLATION:

On the wall. Screw terminal, 3x1x2.5mm² / On the ceiling. Cable, 0.15m, 3x1.0mm²

ENVIRONMENT:

Outdoor

APPLICATION:

Facade illumination / Facade illumination, parking area, public space

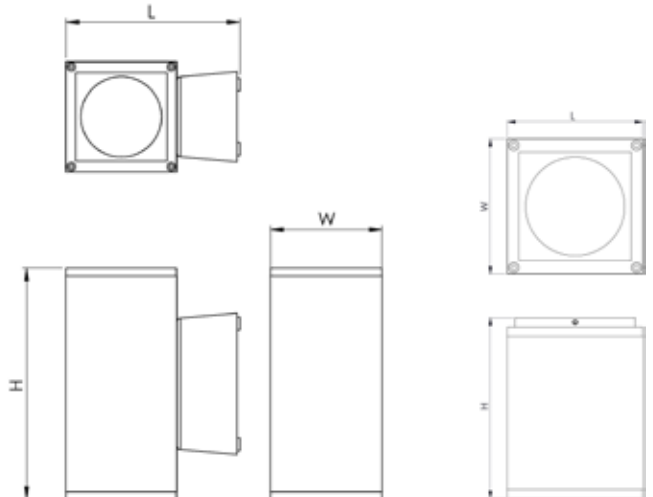

PRODUCT	LENGTH, mm	WIDTH, mm	HEIGHT, mm	LUMINAIRE OUTPUT*, lm	SYSTEM POWER*, W	SYSTEM EFFICI-CACY*, lm/W	CRI	CCT*, K	WEIGHT, kg
Wall-mounted luminaires with up and down light distribution									
Cube LED2x500 J800 T840 R36	130	86	180	1000	12,5	80	80+	4000	1,3
Cube LED2x1250 J801 T840 R36	170	118	220	2447	27,0	91	80+	4000	2,0
Cube LED2x400 J802 T840 L15	130	86	135	769	8,5	90	80+	4000	1,3
Cube LED2x750 J803 T840 L15	170	118	165	1490	17,0	88	80+	4000	1,9
Wall-mounted luminaires with up (or down) light distribution									
Cube UP LED1x700 J804 T840 R36	130	86	180	680	8,5	80	80+	4000	0,9
Cube UP LED1x1100 J805 T840 R36	170	118	220	1064	12,5	85	80+	4000	1,5
Cube UP LED1x400 J806 T840 L15	130	86	135	386	4,5	86	80+	4000	1,3
Cube UP LED1x800 J807 T840 L15	170	118	165	800	8,5	94	80+	4000	1,6
Ceiling-mounted luminaires with down light distribution									
Cube SR LED1x550 J808 T840 R60	118	118	120	520	6,5	80	80+	4000	0,7
Cube SR LED1x700 J809 T840 R60	118	118	120	680	8,5	80	80+	4000	1,6
Cube SR LED1x1100 J810 T840 R90	150	150	120	1089	12,5	87	80+	4000	1,7

*Tolerance range for optical and electrical data: ±10%. Values apply to an ambient temperature of 25°C. NORTHCLIFFE LIGHTING is constantly developing and improving its products. The right is reserved to change any product specifications without prior notification

OPTIONS AVAILABLE ON REQUEST:

LED	REFLECTOR AND OPTICS
T830	R36 ¹
T840	R60 ¹

¹ Option is only available for models: J800; J801; J804; J805

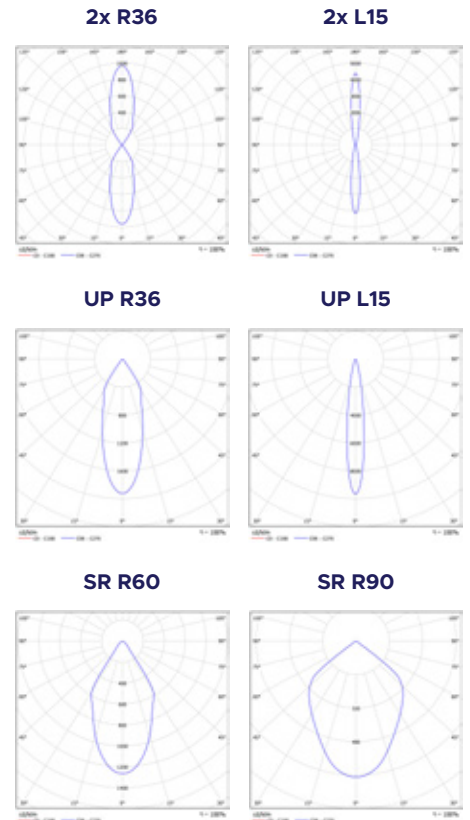

ANGLE LED

Outdoor Accent Lighting

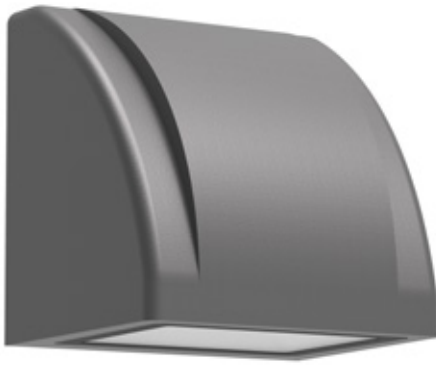

DESCRIPTION: **Wall-mounted LED luminaire**
Light distribution type: direct
Optical system: tempered glass diffuser
Housing: aluminium
Colour: dark grey, RAL7043

GENERAL DATA: **Mains voltage:** 220-240V, 50-60Hz
LED lifetime, h: 50000/L80B50
SDCM: 5
Protection class IEC: I
Ingress protection code: IP65
Mechanical impact resistance: IK08
Operating temperature range, °C: ta -30...+45

INSTALLATION: On the wall. Screw terminal, 3x1x2.5mm²

ENVIRONMENT: Outdoor

APPLICATION: Facade illumination, parking area, park, public space

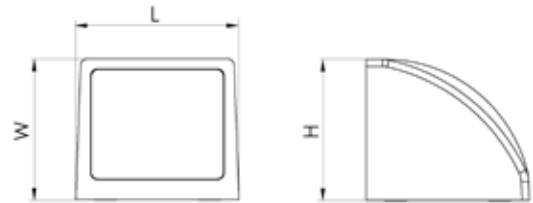

PRODUCT	LENGTH, mm	WIDTH, mm	HEIGHT, mm	LUMINAIRE OUTPUT*, lm	SYSTEM POWER*, W	SYSTEM EFFICACY*, lm/W	CRI	CCT*, K	WEIGHT, kg
Angle LED1x900 J788 T840	111	95	111	875	8,5	103	80+	4000	0,6

*Tolerance range for optical and electrical data: ±10%. Values apply to an ambient temperature of 25°C. NORTHCLIFFE LIGHTING is constantly developing and improving its products. The right is reserved to change any product specifications without prior notification

OPTIONS AVAILABLE ON REQUEST:

LED
T830
T840

STANDARD

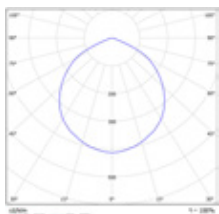

ANTARES LED

Outdoor Accent Lighting



DESCRIPTION: **Surface mounted LED bulkhead**
Light distribution type: direct
Optical system: frosted polycarbonate diffuser, impact resistant
Housing: aluminium
Colour: dark grey, RAL7043

GENERAL DATA: **Mains voltage:** 220-240V, 50-60Hz
LED lifetime, h: 50000/L80B50
SDCM: 5
Protection class IEC: I
Ingress protection code: IP65
Mechanical impact resistance: IK08
Operating temperature range, °C: ta ta -25...+40

INSTALLATION: On the wall. Push-in terminal, 3x2x2.5mm²

ENVIRONMENT: Outdoor

APPLICATION: Facade illumination, transport terminal, parking area, fuel station, public space

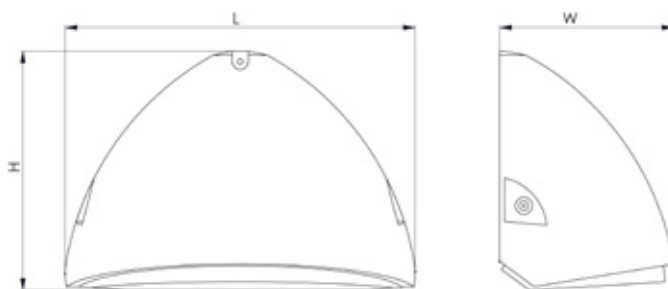

PRODUCT	LENGTH, mm	WIDTH, mm	HEIGHT, mm	LUMINAIRE OUTPUT*, lm	SYSTEM POWER*, W	SYSTEM EFFICACY*, lm/W	CRI	CCT*, K	WEIGHT, kg
Antares LED1x1850/2550/3600 J626 T840/T830	319	165	265	1829/2535/3567	13,0/18,0/28,0	141/141/127	80+	4000/3000	1,9
Antares LED1x1850/2550/3600 J626 T840 LS1A40	319	165	265	1829/2535/3567	13,0/18,0/28,0	141/141/127	80+	4000	1,9

*Tolerance range for optical and electrical data: ±10%. Values apply to an ambient temperature of 25°C. NORTHCLIFFE LIGHTING is constantly developing and improving its products. The right is reserved to change any product specifications without prior notification

OPTIONS AVAILABLE ON REQUEST:

LED	CONTROL GEAR	EMERGENCY	CONNECTION	COLOUR
T830 ¹	DALI ²	EM3 ³	CBF3x1.5-N m ⁴	RAL
T840		EM3B ³	CBF5x1.5-N m ⁴	
		EM3A ³		
		EM3D ³		
		EM3Atmin-25		

STANDARD

LS1A40

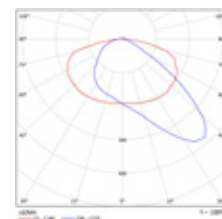
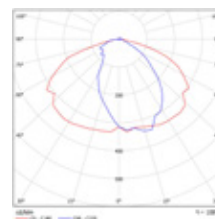

- ¹ T830 option is not applicable with LS1A40 models
- ² For DALI option, indicate what output is required
- ³ Operating temperature range for Luminaires with EM option, C: ta 0... +30
- ⁴ Please specify the length of outgoing cable before placing an order

ETA LED

Outdoor Accent Lighting



DESCRIPTION: **Surface mounted accent LED luminaire**
Light distribution type: direct
Optical system: opal polycarbonate diffuser, UV stable, impact resistant
Housing: aluminium
Colour: dark grey, RAL7043

GENERAL DATA: **Mains voltage:** 220-240V, 0/50-60Hz
LED lifetime, h: 50000/L80B10
SDCM: 3
Protection class IEC: I
Ingress protection code: IP65
Mechanical impact resistance: IK10
Operating temperature range, °C: ta
 -20...+40/ -25...+35

INSTALLATION: On the walls or ceiling. Push-in terminal, 3x2x2.5mm²

ENVIRONMENT: Outdoor

APPLICATION: Facade illumination, parking area, public space

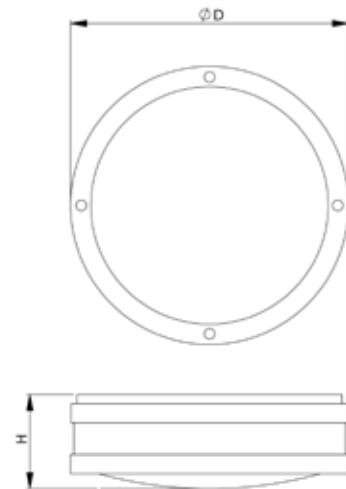

PRODUCT	DIAMETER, mm	HEIGHT, mm	LUMINAIRE OUTPUT*, lm	SYSTEM POWER*, W	SYSTEM EFFICACY*, lm/W	CRI	CCT*, K	WEIGHT, kg
Eta M 1E27 C404	265	90						1,6
Eta M LED1x1200 D036 T840	265	90	1143	14,3	80	80+	4000	1,6
Eta M 1E27 C404 LOUVER	265	100						1,9
Eta M LED1x700 D037 T840 LOUVER	265	100	700	11,0	63	80+	4000	1,8
Eta B 1E27 Q78	360	130						2,4
Eta B 2E27 S53	360	130						2,4
Eta B LED1x1300 D057 T840	360	130	1164	13,8	84	80+	4000	3,1
Eta B LED1x1800 D038 T840	360	130	1600	19,5	82	80+	4000	3,1
Eta B LED1x2000 G919 T840	360	130	1956	23,6	83	80+	4000	3,1
Eta B 1E27 Q78 LOUVER	360	145						2,5
Eta B 2E27 S53 LOUVER	360	145						2,5
Eta B LED1x700 D051 T840 LOUVER	360	145	582	10,2	57	80+	4000	3,3
Eta B LED1x1000 D039 T840 LOUVER	360	145	800	14,3	56	80+	4000	3,3

*Tolerance range for optical and electrical data: ±10%. Values apply to an ambient temperature of 25°C. NORTHCLIFFE LIGHTING is constantly developing and improving its products. The right is reserved to change any product specifications without prior notification

OPTIONS AVAILABLE ON REQUEST:

LED	CONTROL GEAR	SENSORS	EMERGENCY	COLOUR
T830	DALI	MW ¹ 2	EM3 ³	RAL
T840			EM3B ³	
			EM3A ³	
			EM3D ³	

1 In outdoor environment frequently moving objects (eg. trees, bushes, flags) can impact MW sensor operation

2 MW option is not compatible with LOUVER models and EM options

3 Operating temperature range for Luminaires with EM option, °C: ta 0... +35

STANDARD

LOUVER

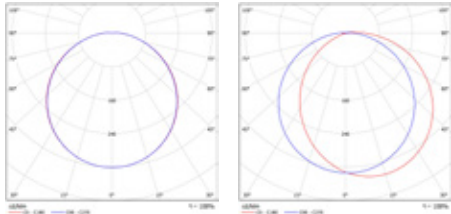

OVAL LED

Outdoor Accent Lighting



- DESCRIPTION:** Surface mounted anti-vandal LED bulkhead
Light distribution type: direct
Optical system: opal polycarbonate diffuser, impact resistant
Housing: aluminium
Colour: dark grey, RAL7043
-
- GENERAL DATA:** Mains voltage: 220-240V, 50-60Hz
LED lifetime, h: 50000/L80B10
SDCM: 3
Protection class IEC: I
Ingress protection code: IP54
Mechanical impact resistance: IK08
Operating temperature range, °C: ta -25...+40
-
- INSTALLATION:** On the wall. Push-in terminal, 3x2x2.5mm²
-
- ENVIRONMENT:** Outdoor
-
- APPLICATION:** Facade illumination, parking area, public space

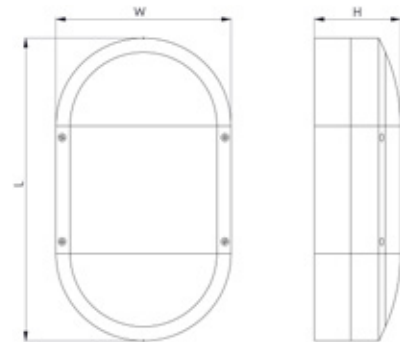

PRODUCT	LENGTH, mm	WIDTH, mm	HEIGHT, mm	LUMINAIRE OUTPUT*, lm	SYSTEM POWER*, W	SYSTEM EFFICACY*, lm/W	CRI	CCT*, K	WEIGHT, kg
Oval B 1E27 Q83	280	185	95						
Oval B LED1x900 D055 T840	280	185	95	901	9,4	96	80+	4000	1,5
Oval B 1E27 Q83 GRID	280	185	95						
Oval B 1E27 Q83 LOUVER	280	185	95						
Oval B LED1x500 D056 T840 LOUVER	280	185	95	476	7,1	67	80+	4000	1,6

*Tolerance range for optical and electrical data: ±10%. Values apply to an ambient temperature of 25°C. NORTHCLIFFE LIGHTING is constantly developing and improving its products. The right is reserved to change any product specifications without prior notification

OPTIONS AVAILABLE ON REQUEST:

LED	PROTECTION	COLOUR
T830	IP65	RAL
T840		

STANDARD

LOUVER

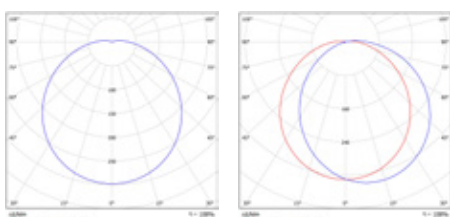

THETA LED

Outdoor Accent Lighting

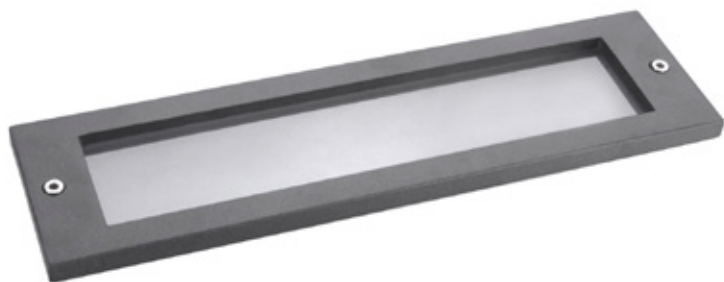

DESCRIPTION: Recessed wall-mounted accent LED luminaire
Light distribution type: direct
Optical system: frosted tempered glass diffuser, impact resistant
Housing: aluminium
Colour: dark grey, RAL7043

GENERAL DATA: **Mains voltage:** 220-240V, 50-60Hz
LED lifetime, h: 50000/L80B10
SDCM: 3
Protection class IEC: I
Ingress protection code: IP54
Mechanical impact resistance: IK08
Operating temperature range, °C: ta -25...+40

INSTALLATION: Into the wall. Push-in terminal, 3x2x2.5mm²

ENVIRONMENT: Outdoor

APPLICATION: Facade illumination, underground passage, park, public space

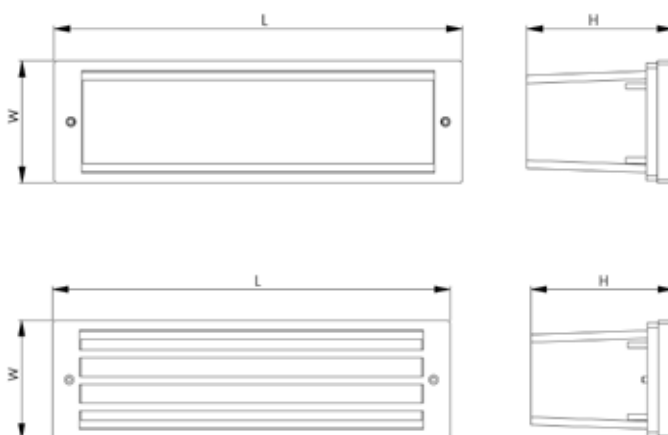

PRODUCT	LENGTH, mm	WIDTH, mm	HEIGHT, mm	CUT-OUT, mm	LUMINAIRE OUTPUT*, lm	SYSTEM POWER*, W	SYSTEM EFFICACY*, lm/W	CRI	CCT*, K	WEIGHT, kg
Theta 1E27 Q75	255	70	95	257x75x95						1,2
Theta LED1x300 D058 T840	255	70	95	257x75x95	232	3,6	64	80+	4000	1,2
Theta 1E27 Q75 GRID	255	70	95	257x75x95						1,2
Theta LED1x300 D058 T840 GRID	255	70	95	257x75x95	116	3,6	32	80+	4000	1,2

*Tolerance range for optical and electrical data: ±10%. Values apply to an ambient temperature of 25°C. NORTHCLIFFE LIGHTING is constantly developing and improving its products. The right is reserved to change any product specifications without prior notification

OPTIONS AVAILABLE ON REQUEST:

LED	COLOUR
T830	RAL
T840	

STANDARD

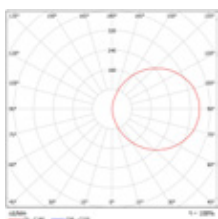

THUBAN A LED

Outdoor Accent Lighting



DESCRIPTION: **Recessed wall-mounted accent LED luminaire**
Light distribution type: direct
Optical system: opal PC diffuser, asymmetrical
Housing: aluminium
Colour: dark grey, RAL7043

GENERAL DATA: **Mains voltage:** 220-240V, 50-60Hz
LED lifetime, h: 50000/L80B50
SDCM: 3
Protection class IEC: I
Ingress protection code: IP65
Mechanical impact resistance: IK08
Operating temperature range, °C: ta -30...+45

INSTALLATION: Into the wall. Cable, 0.15m, 3x1.0mm²

ENVIRONMENT: Outdoor

APPLICATION: Staircase, park, public space

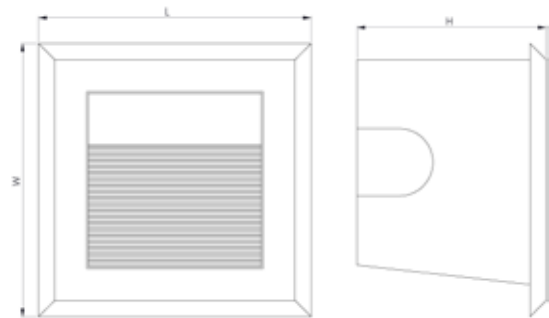

PRODUCT	LENGTH, mm	WIDTH, mm	HEIGHT, mm	CUT-OUT, mm	LUMINAIRE OUTPUT*, lm	SYSTEM POWER*, W	SYSTEM EFFICACY*, lm/W	CRI	CCT*, K	WEIGHT, kg
Thuban A LED1x100 J811 T840	85	85	59	80x80x56	57	2,5	23	80+	4000	0,2

*Tolerance range for optical and electrical data: ±10%. Values apply to an ambient temperature of 25°C. NORTHCLIFFE LIGHTING is constantly developing and improving its products. The right is reserved to change any product specifications without prior notification

OPTIONS AVAILABLE ON REQUEST:

LED
T830
T840

STANDARD

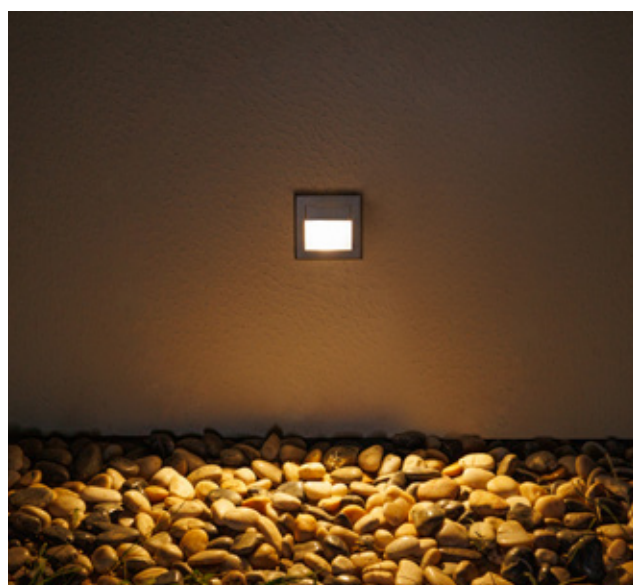
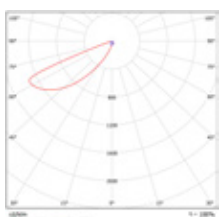

THUBAN B LED

Outdoor Accent Lighting



DESCRIPTION: Recessed wall-mounted accent LED luminaire
Light distribution type: direct
Optical system: opal PC diffuser, asymmetrical
Housing: aluminium
Colour: dark grey, RAL7043

GENERAL DATA: **Mains voltage:** 220-240V, 50-60Hz
LED lifetime, h: 50000/L80B50
SDCM: 5
Protection class IEC: I
Ingress protection code: IP65
Mechanical impact resistance: IK08
Operating temperature range, °C: ta -30...+45

INSTALLATION: Into the wall. Cable, 0.15m, 3x1.0mm²

ENVIRONMENT: Outdoor

APPLICATION: Staircase, park, public space



PRODUCT	LENGTH, mm	WIDTH, mm	HEIGHT, mm	CUT-OUT, mm	LUMINAIRE OUTPUT*, lm	SYSTEM POWER*, W	SYSTEM EFFICACY*, lm/W	CRI	CCT*, K	WEIGHT, kg
Thuban B LED1x200 J812 T840	170	90	71	162x87x71	167	6,5	26	80+	4000	0,7

*Tolerance range for optical and electrical data: ±10%. Values apply to an ambient temperature of 25°C. NORTHCLIFFE LIGHTING is constantly developing and improving its products. The right is reserved to change any product specifications without prior notification

OPTIONS AVAILABLE ON REQUEST:

LED
T830
T840

STANDARD

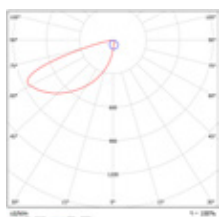

THABIT Q LED

Outdoor Accent Lighting

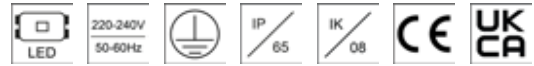

DESCRIPTION: **Wall-mounted accent LED luminaire**
Light distribution type: direct
Optical system: opal PC diffuser, asymmetrical
Housing: aluminium
Colour: dark grey, RAL7043

GENERAL DATA: **Mains voltage:** 220-240V, 50-60Hz
LED lifetime, h: 50000/L80B50
SDCM: 5
Protection class IEC: I
Ingress protection code: IP65
Mechanical impact resistance: IK08
Operating temperature range, °C: ta -30...+45

INSTALLATION: On the wall. Cable, 0.15m, 3x1.0mm²

ENVIRONMENT: Outdoor

APPLICATION: Staircase, park, public space



PRODUCT	LENGTH, mm	WIDTH, mm	HEIGHT, mm	LUMINAIRE OUTPUT*, lm	SYSTEM POWER*, W	SYSTEM EFFICACY*, lm/W	CRI	CCT*, K	WEIGHT, kg
Thabit Q LED1x400 J813 T840	200	200	52	366	8,5	43	80+	4000	1,1

*Tolerance range for optical and electrical data: ±10%. Values apply to an ambient temperature of 25°C. NORTHCLIFFE LIGHTING is constantly developing and improving its products. The right is reserved to change any product specifications without prior notification

OPTIONS AVAILABLE ON REQUEST:

LED
T830
T840

STANDARD

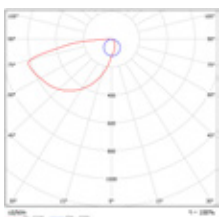

FLOOR LED

Outdoor Accent Lighting



DESCRIPTION: **Ground-mounted LED luminaire**
Light distribution type: direct
Optical system: frosted tempered glass diffuser, impact resistant
Housing: stainless steel
Colour: stainless-steel, brushed

GENERAL DATA: **Mains voltage:** 220-240V, 0/50-60Hz
LED lifetime, h: 50000/L80B10
SDCM: 3
Protection class IEC: I
Ingress protection code: IP67
Mechanical impact resistance: IK10
Operating temperature range, °C: ta -25...+40

INSTALLATION: In the ground. Cable, 1.0m, 3x1.5mm²

ENVIRONMENT: Outdoor

APPLICATION: Facade illumination, public space



PRODUCT	LENGTH, mm	WIDTH, mm	HEIGHT, mm	CUT-OUT, mm	LUMINAIRE OUTPUT*, lm	SYSTEM POWER*, W	SYSTEM EFFICACY*, lm/W	CRI	CCT*, K	WEIGHT, kg
Floor LED1x450 J692 T840	430	115	105	410x105x110	431	5,3	81	80+	4000	3,1
Floor LED1x550 J693 T840	430	115	105	410x105x110	529	6,7	79	80+	4000	3,1
Floor LED1x800 J694 T840	630	115	105	610x105x110	754	9,3	81	80+	4000	4,6
Floor LED1x950 J695 T840	630	115	105	610x105x110	926	11,1	83	80+	4000	4,6
Floor LED1x1450 J696 T840	1050	115	105	1025x105x110	1401	16,5	85	80+	4000	7,2
Floor LED1x1750 J697 T840	1050	115	105	1025x105x110	1721	19,9	86	80+	4000	7,2

*Tolerance range for optical and electrical data: ±10%. Values apply to an ambient temperature of 25°C. NORTHCLIFFE LIGHTING is constantly developing and improving its products. The right is reserved to change any product specifications without prior notification

AVAILABLE ACCESSORIES:



Product: Power supply connector I IP68 2x3x2.5mm²
Description: Connection box IP68 filled with gel, "I" type, 2x3x2.5mm², 250V/6A, external cable diameter: 5,5-10mm, 1pcs
**For installation IP68 waterproof connectors are recommended*



Product: Power supply connector T IP68 3x3x2.5mm²
Description: Junction box IP68 filled with gel, "T" type, 3x3x2.5mm², 250V/16A, external cable diameter: 6,5-12mm, luminaire cable diameter: 5,5-10mm, 1pcs
**For installation IP68 waterproof connectors are recommended*

OPTIONS AVAILABLE ON REQUEST:

LED	CONTROL GEAR
T830	DALI
T840	

STANDARD

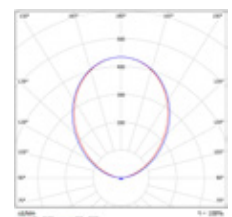

ATLAS LED

Outdoor Accent Lighting



DESCRIPTION: **Ground-mounted LED luminaire**
Light distribution type: direct
Optical system: lens, tempered glass diffuser, impact resistant
Housing: aluminium, dark grey, RAL7043
Frame: stainless-steel, brushed

GENERAL DATA: **Mains voltage:** 220-240V, 50-60Hz
LED lifetime, h: 40000/L80B50 (40000/L70B50 for model D456)
SDCM: 3
Protection class IEC: I
Ingress protection code: IP67
Mechanical impact resistance: IK10
Operating temperature range, °C: ta -25...+40

INSTALLATION: In the ground. Cable, 1.0m, 3x1.5mm²

ENVIRONMENT: Outdoor

APPLICATION: Facade illumination, public space



PRODUCT	DIAMETER, mm	HEIGHT, mm	CUT-OUT, mm	LUMINAIRE OUTPUT*, lm	SYSTEM POWER*, W	SYSTEM EFFICACY*, lm/W	CRI	CCT*, K	WEIGHT, kg
Atlas LED1x1650 J725 T840 L30	210	120	200x125	1636	12,8	128	80+	4000	2,2
Atlas LED1x2250 J726 T840 L30	210	120	200x125	2223	18,7	119	80+	4000	2,2
Atlas LED1x2250 J727 T840 L30	260	125	250x130	2223	18,7	119	80+	4000	3,3
Atlas LED1x3000 J728 T840 L30	260	125	250x130	2993	26,8	112	80+	4000	3,3
Atlas LED1x3000 J729 T840 L30	320	160	310x165	2993	26,8	112	80+	4000	5,2
Atlas LED1x3800 J730 T840 L30	320	160	310x165	3754	34,3	109	80+	4000	5,2

*Tolerance range for optical and electrical data: ±10%. Values apply to an ambient temperature of 25°C. NORTHCLIFFE LIGHTING is constantly developing and improving its products. The right is reserved to change any product specifications without prior notification

AVAILABLE ACCESSORIES:



Product: Power supply connector I IP68 2x3x2.5mm²

Description: Connection box IP68 filled with gel, "I" type, 2x3x2.5mm², 250V/6A, external cable diameter: 5,5-10mm, 1pcs

*For installation IP68 waterproof connectors are recommended



Product: Power supply connector T IP68 3x3x2.5mm²

Description: Junction box IP68 filled with gel, "T" type, 3x3x2.5mm², 250V/16A, external cable diameter: 6,5-12mm, luminaire cable diameter: 5,5-10mm, 1pcs

*For installation IP68 waterproof connectors are recommended

OPTIONS AVAILABLE ON REQUEST:

LED	CONTROL GEAR
T830	DALI
T840	

L30

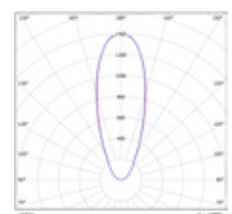

ATLAS S LED

Outdoor Accent Lighting



COVER1



COVER2



COVER12



SQUARE

DESCRIPTION: **Ground-mounted LED luminaire**
Light distribution type: direct
Optical system: tempered glass diffuser, impact resistant
Housing: aluminium, dark grey, RAL7043
Frame: stainless-steel, brushed

GENERAL DATA: **Mains voltage:** 220-240V, 50-60Hz
LED lifetime, h: 15000/L70B50
Protection class IEC: I
Ingress protection code: IP67
Mechanical impact resistance: IK10
Operating temperature range, °C: ta -25..+40

INSTALLATION: In the ground (recessed installation housing included). Cable, 0.3m, 3x0.75mm²

ENVIRONMENT: Outdoor

APPLICATION: Facade illumination, park, public space

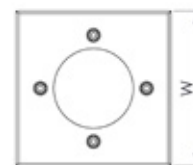
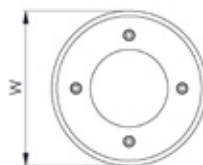
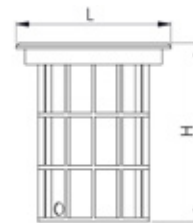
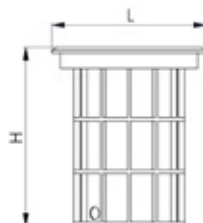

PRODUCT	LENGTH, mm	WIDTH, mm	HEIGHT, mm	CUT-OUT, mm	LUMINAIRE OUTPUT*, lm	SYSTEM POWER*, W	SYSTEM EFFICACY*, lm/W	CRI	CCT*, K	WEIGHT, kg
Series with AISI 316 stainless steel frame										
Atlas S 1GU10 Q72	105	105	165	110x135						1,4
Atlas S 1GU10 Q72 GLASS COVER1	105	105	165	110x135						1,4
Atlas S 1GU10 Q72 GLASS COVER2	105	105	165	110x135						1,4
Atlas S 1GU10 Q72 GLASS COVER12	105	105	165	110x135						1,4
Atlas S LED1x400 G867 T840 L40	105	105	165	110x135	397	4,2	95	80+	4000	1,4
Series with AISI 304 stainless steel frame										
Atlas S 1GU10 Q72 SS304	105	105	165	110x135						1,4
Atlas S 1GU10 Q72 SS304 SQUARE	105	105	165	110x135						1,4
Atlas S LED1x400 G868 T840 SS304 L40	105	105	165	110x135	397	4,2	95	80+	4000	1,4
Atlas S LED1x400 G869 T840 SS304 L40 SQUARE	105	105	165	110x135	397	4,2	95	80+	4000	1,4

*Tolerance range for optical and electrical data: ±10%. Values apply to an ambient temperature of 25°C. NORTHCLIFFE LIGHTING is constantly developing and improving its products. The right is reserved to change any product specifications without prior notification

OPTIONS AVAILABLE ON REQUEST:

LED
T830
T840

L40

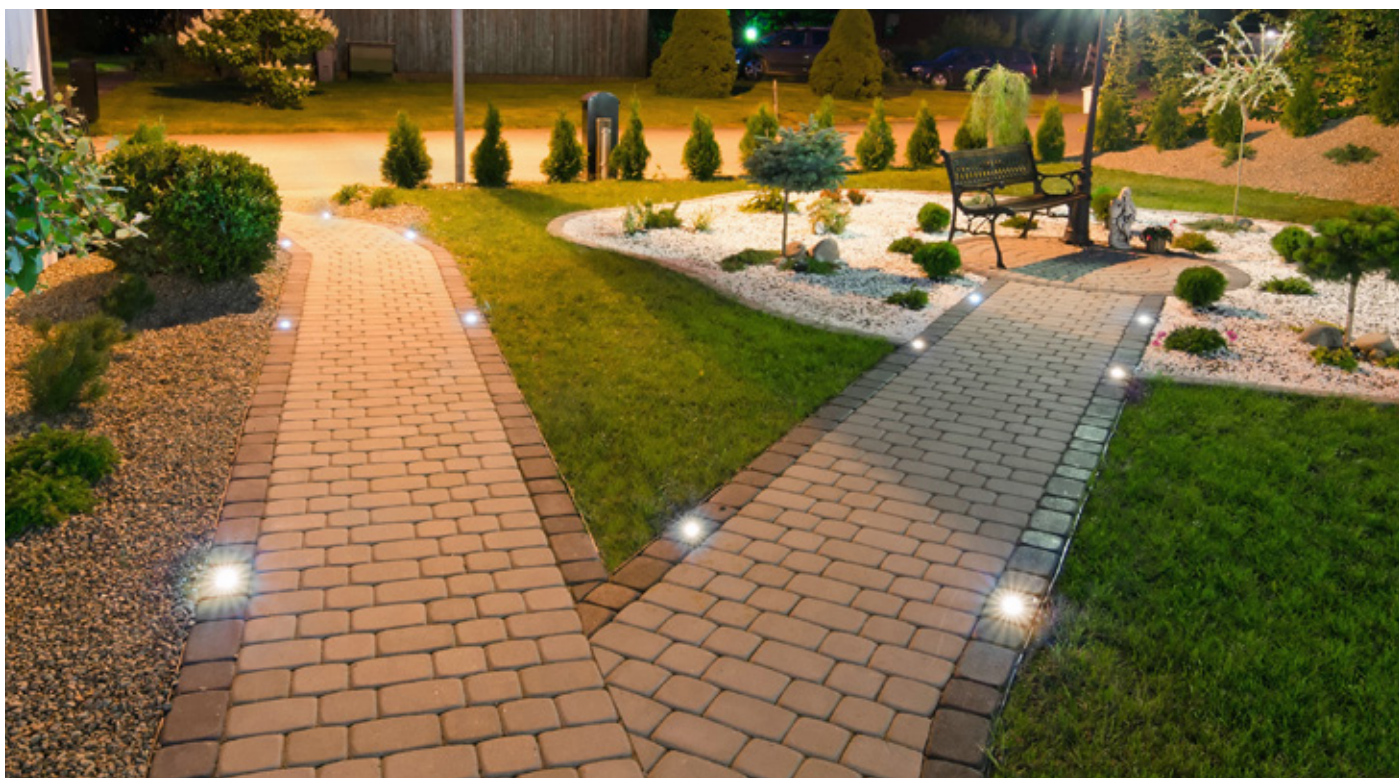
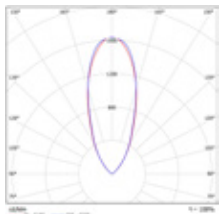

KAPPA LED

Outdoor Accent Lighting



DESCRIPTION: **Surface mounted accent LED luminaire**
Light distribution type: direct
Optical system: tempered glass diffuser, impact resistant
Housing: aluminium
Colour: dark grey, RAL7043

GENERAL DATA: **Mains voltage:** 220-240V, 50-60Hz
LED lifetime, h: 15000/L70B50
Protection class IEC: I
Ingress protection code: IP65
Mechanical impact resistance: IK08
Operating temperature range, °C: ta -25...+40

INSTALLATION: On the wall. Screw terminal, 3x2.5mm²

ENVIRONMENT: Outdoor

APPLICATION: Facade illumination

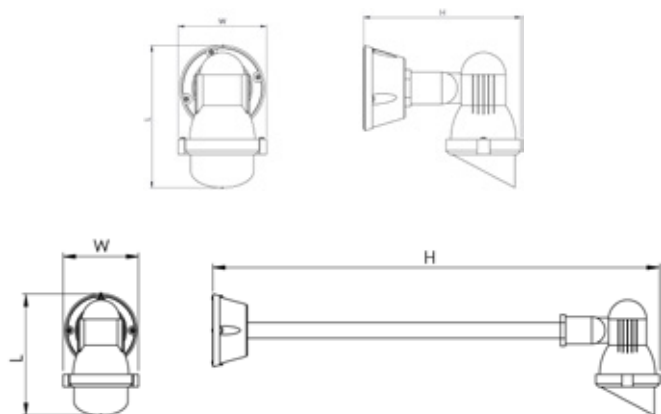

PRODUCT	LENGTH, mm	WIDTH, mm	HEIGHT, mm	LUMINAIRE OUTPUT*, lm	SYSTEM POWER*, W	SYSTEM EFFICACY*, lm/W	CRI	CCT*, K	WEIGHT, kg
Kappa 1GU10 Q87	150	101	210						0,7
Kappa 1GU10 Q88 LONG	150	101	605						1,2
Kappa LED1x400 G870 T840 L40	150	101	210	397	4,2	95	80+	4000	1,4
Kappa LED1x400 G871 T840 LONG L40	150	101	605	397	4,2	95	80+	4000	1,4

*Tolerance range for optical and electrical data: ±10%. Values apply to an ambient temperature of 25°C. NORTHCLIFFE LIGHTING is constantly developing and improving its products. The right is reserved to change any product specifications without prior notification

OPTIONS AVAILABLE ON REQUEST:

LED	COLOUR
T830	RAL
T840	

STANDARD

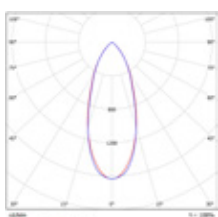

APUS LED

Outdoor Accent Lighting

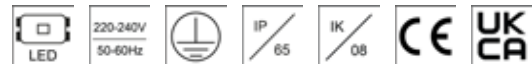

DESCRIPTION: Surface or ground-mounted LED luminaire
Light distribution type: direct
Optical system: tempered glass diffuser, impact resistant
Housing: aluminium
Colour: dark grey, RAL7043

GENERAL DATA: Mains voltage: 220-240V, 50-60Hz
 LED lifetime, h: 15000/L70B50
 Protection class IEC: I
 Ingress protection code: IP65
 Mechanical impact resistance: IK08
 Operating temperature range, °C: ta -25...+40

INSTALLATION: On the horizontal or vertical surface, on the ground or in the ground. Cable, 0.35m, 3x1.0mm²

ENVIRONMENT: Outdoor

APPLICATION: Facade illumination, park, public space

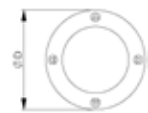
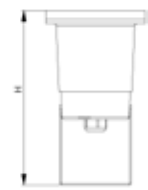
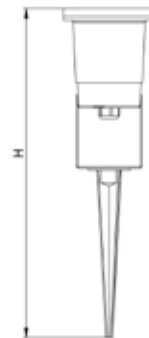

Apus LED GRO

Apus LED HOL

PRODUCT	DIAMETER, mm	HEIGHT, mm	LUMINAIRE OUTPUT*, lm	SYSTEM POWER*, W	SYSTEM EFFICACY*, lm/W	CRI	CCT*, K	WEIGHT, kg
Apus 1GU10 O11 HOL	90	150						0,5
Apus 1GU10 O12 GRO	90	310						1,4
Apus LED1x400 G872 T840 HOL L40	90	150	392	4,2	93	80+	4000	0,5
Apus LED1x400 G873 T840 GRO L40	90	310	392	4,2	93	80+	4000	1,4

*Tolerance range for optical and electrical data: ±10%. Values apply to an ambient temperature of 25°C. NORTHCLIFFE LIGHTING is constantly developing and improving its products. The right is reserved to change any product specifications without prior notification

OPTIONS AVAILABLE ON REQUEST:

LED	COVERS	COLOUR
T830	LOUVER	RAL
T840		

STANDARD

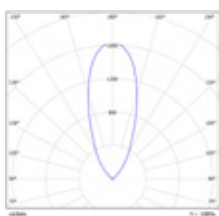

ANCHA LED

Outdoor Accent Lighting



DESCRIPTION:	Ground-mounted accent LED luminaire Light distribution type: direct Optical system: tempered glass diffuser, aluminium reflector, 15°/25°/45° beam angle Housing: aluminium Colour: black, RAL9005
GENERAL DATA:	Mains voltage: 220-240V, 50-60Hz LED lifetime, h: 50000/L80B50 SDCM: 5 Protection class IEC: I Ingress protection code: IP65 Mechanical impact resistance: IK06 Operating temperature range, °C: ta -25...+45
INSTALLATION:	On the horizontal or vertical surface. Cable, 0.45m, 3x1.0mm ²
ENVIRONMENT:	Outdoor
APPLICATION:	Facade illumination, park, public space

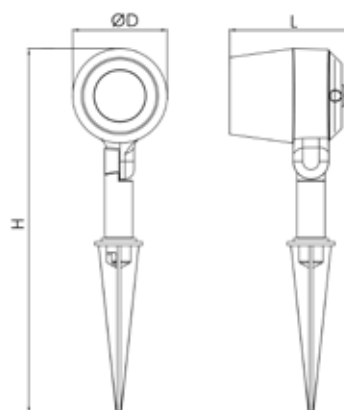

PRODUCT	LENGTH, mm	DIAMETER, mm	HEIGHT, mm	LUMINAIRE OUTPUT*, lm	SYSTEM POWER*, W	SYSTEM EFFICACY*, lm/W	CRI	CCT*, K	WEIGHT, kg
Ancha LED1x950 J785 T840 R15	104	80	309	909	8,0	114	80+	4000	0,4
Ancha LED1x950 J785 T840 R25	104	80	309	903	8,0	113	80+	4000	0,4
Ancha LED1x950 J785 T840 R45	104	80	309	916	8,0	115	80+	4000	0,4

*Tolerance range for optical and electrical data: ±10%. Values apply to an ambient temperature of 25°C. NORTHCLIFFE LIGHTING is constantly developing and improving its products. The right is reserved to change any product specifications without prior notification

AVAILABLE ACCESSORIES:



Product: SURFACE HOLDER KIT - ANCHA LED
Description: Surface mounting kit

OPTIONS AVAILABLE ON REQUEST:

LED
T830
T840

R15

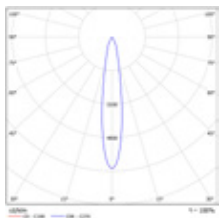

R25

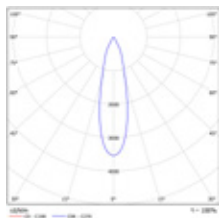

R45

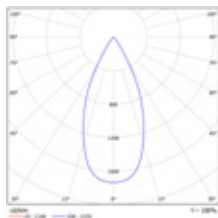

NORTHCLIFFE
making life brighter

PARK AND STREET LUMINAIRES





NIGEA LED

Park and Street Luminaires

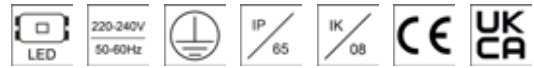

DESCRIPTION: **Ground-mounted LED bollard**
Light distribution type: Omnidirectional
Optical system: matt aluminium reflector, clear polycarbonate diffuser, impact resistant
Housing: aluminium
Colour: dark grey, RAL7043

GENERAL DATA: **Mains voltage:** 220-240V, 0/50-60Hz
LED lifetime, h: 50000/L80B10
SDCM: 3
Protection class IEC: I
Ingress protection code: IP65
Mechanical impact resistance: IK08
Operating temperature range, °C: ta -30...+35

INSTALLATION: On the ground (flange mounting plate included). Screw terminal, 3x1x1.5mm²

ENVIRONMENT: Outdoor

APPLICATION: Park, public space



PRODUCT	DIAMETER, mm	HEIGHT, mm	LUMINAIRE OUTPUT*, lm	SYSTEM POWER*, W	SYSTEM EFFICACY*, lm/W	CRI	CCT*, K	WEIGHT, kg
Nigea LED1x1650 G989 T840	165	805	1627	14,3	114	80+	4000	3,5

*Tolerance range for optical and electrical data: ±10%. Values apply to an ambient temperature of 25°C. NORTHCLIFFE LIGHTING is constantly developing and improving its products. The right is reserved to change any product specifications without prior notification

AVAILABLE ACCESSORIES:



Product: Ground MTG KIT - Nigea LED
Description: Kit for mounting the luminaire to the ground

OPTIONS AVAILABLE ON REQUEST:

LED	CONTROL GEAR	CONNECTION	COLOUR
T830	DALI	LOOP	RAL
T840			

STANDARD

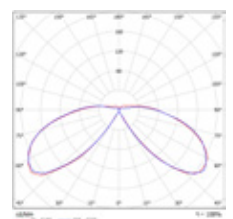

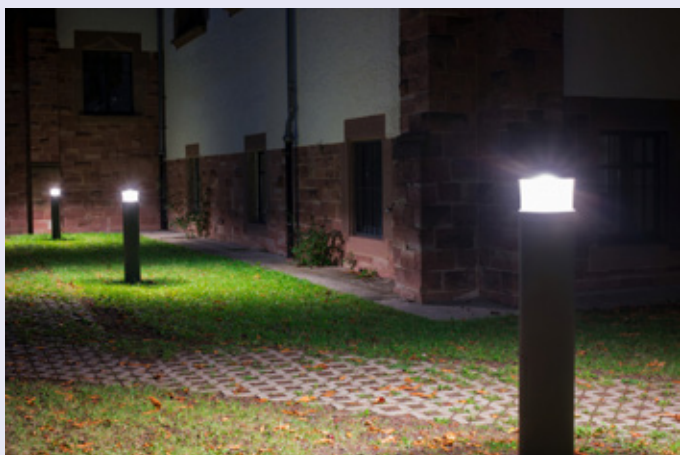



NODUS LED

Park and Street Luminaires



DESCRIPTION: **Ground-mounted LED bollard**
Light distribution type: direct
Optical system: white thermoplastic reflector, clear polycarbonate diffuser, impact resistant
Housing: aluminium
Colour: dark grey, RAL7043

GENERAL DATA: **Mains voltage:** 220-240V, 50-60Hz
LED lifetime, h: 50000/L80B50
SDCM: 5
Protection class IEC: I
Ingress protection code: IP65
Mechanical impact resistance: IK08
Operating temperature range, °C: ta -20...+35

INSTALLATION: On the ground (flange mounting plate included). Screw terminal, 3x1x1.5mm²

ENVIRONMENT: Outdoor

APPLICATION: Park, public space



PRODUCT	LENGTH, mm	WIDTH, mm	HEIGHT, mm	LUMINAIRE OUTPUT*, lm	SYSTEM POWER*, W	SYSTEM EFFICACY*, lm/W	CRI	CCT*, K	WEIGHT, kg
Nodus LED1x1200 J707 T840	150	150	800	1197	14,0	86	80+	4000	3,9

*Tolerance range for optical and electrical data: ±10%. Values apply to an ambient temperature of 25°C. NORTHCLIFFE LIGHTING is constantly developing and improving its products. The right is reserved to change any product specifications without prior notification

AVAILABLE ACCESSORIES:



Product: Ground MTG KIT - Nigea LED
Description: Kit for mounting the luminaire to the ground

OPTIONS AVAILABLE ON REQUEST:

LED	CONTROL GEAR	CONNECTION	COLOUR
T830	DALI	LOOP	RAL
T840			

STANDARD

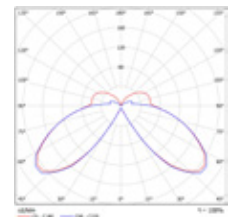





SPHERE LED

Park and Street Luminaires

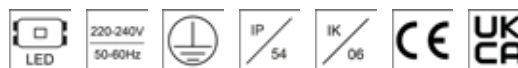

DESCRIPTION: Pole-mounted LED park luminaire
Light distribution type: direct
Optical system: opal acrylic diffuser, UV stabilized, impact resistant
Housing: polycarbonate
Colour: black

GENERAL DATA: **Mains voltage:** 220-240V, 0/50-60Hz
LED lifetime, h: 50000/L80B10
SDCM: 3
Protection class IEC: I (II optional)
Ingress protection code: IP54
Mechanical impact resistance: IK06
Operating temperature range, °C: ta -30...+45

INSTALLATION: With three screws on poles Ø60mm. Push-in terminal, 3x2x2.5mm²

ENVIRONMENT: Outdoor

APPLICATION: Parking area, park, public space

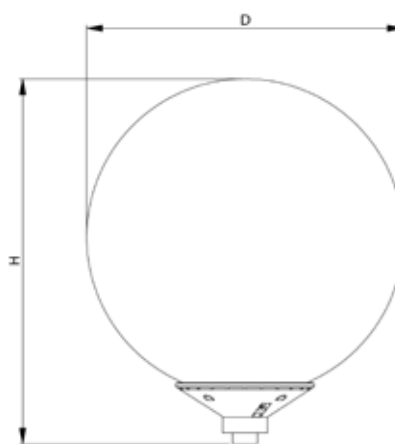

PRODUCT	DIAMETER, mm	HEIGHT, mm	LUMINAIRE OUTPUT*, lm	SYSTEM POWER*, W	SYSTEM EFFICACY*, lm/W	CRI	CCT*, K	WEIGHT, kg
Sphere LED1x3300 G930 T840 OP PMMA	500	555	3251	21,4	152	80+	4000	4,9
Sphere LED1x4300 G931 T840 OP PMMA	500	555	4278	28,7	149	80+	4000	4,9
Sphere LED1x6400 G932 T840 OP PMMA	500	555	6359	42,6	149	80+	4000	4,9
Sphere LED1x2450 G933 T840 OP PMMA	400	470	2438	16,2	150	80+	4000	3,7
Sphere LED1x3250 G934 T840 OP PMMA	400	470	3209	21,8	147	80+	4000	3,7

*Tolerance range for optical and electrical data: ±10%. Values apply to an ambient temperature of 25°C. NORTHCLIFFE LIGHTING is constantly developing and improving its products. The right is reserved to change any product specifications without prior notification

OPTIONS AVAILABLE ON REQUEST:

LED	MATERIAL	CONTROL GEAR	CONNECTION	PROTECTION
T830	PC ¹	DALI	CBF3x1.5-N m ²	II
T840		ADIM		
		COR		
		COR1min		
		COR30min		

OP PMMA

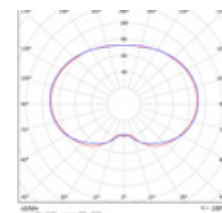

1 Luminaire output with PC option is about 20% lower
 2 Please specify the length of outgoing cable before placing an order



SIGNUS LED

Park and Street Luminaires



DESCRIPTION: Pole-mounted LED park luminaire
Light distribution type: direct
Optical system: frosted polycarbonate diffuser, impact resistant
Housing: aluminium
Colour: dark grey, RAL7043

GENERAL DATA: **Mains voltage:** 220-240V, 0/50-60Hz / 50-60Hz
LED lifetime, h: 50000/L80B10
SDCM: 3
Protection class IEC: I (II optional)
Ingress protection code: IP65
Mechanical impact resistance: IK08
Operating temperature range, °C: ta -25...+40

INSTALLATION: With three screws on poles Ø60mm. Cable, 3.0m, 3x0.75mm²

ENVIRONMENT: Outdoor

APPLICATION: Park, public space

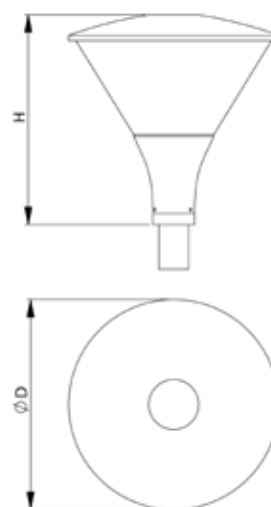

PRODUCT	DIAMETER, mm	HEIGHT, mm	LUMINAIRE OUTPUT*, lm	SYSTEM POWER*, W	SYSTEM EFFICACY*, lm/W	CRI	CCT*, K	WEIGHT, kg
Signus LED1x2700 G663 T840	420	420	2655	18,6	143	80+	4000	4,9
Signus LED1x3650 G664 T840	420	420	3617	26,3	138	80+	4000	4,9
Signus LED1x4550 G665 T840	420	420	4521	34,4	131	80+	4000	4,9
Signus LED1x5200 G666 T840	420	420	5195	41,2	126	80+	4000	4,9

*Tolerance range for optical and electrical data: ±10%. Values apply to an ambient temperature of 25°C. NORTHCLIFFE LIGHTING is constantly developing and improving its products. The right is reserved to change any product specifications without prior notification

OPTIONS AVAILABLE ON REQUEST:

LED	CONTROL GEAR	SENSORS	PROTECTION	COLOUR
T830	DALI	PCA	II	RAL
T840				

STANDARD

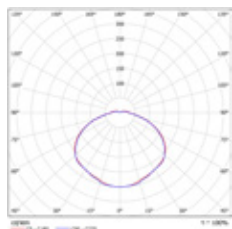

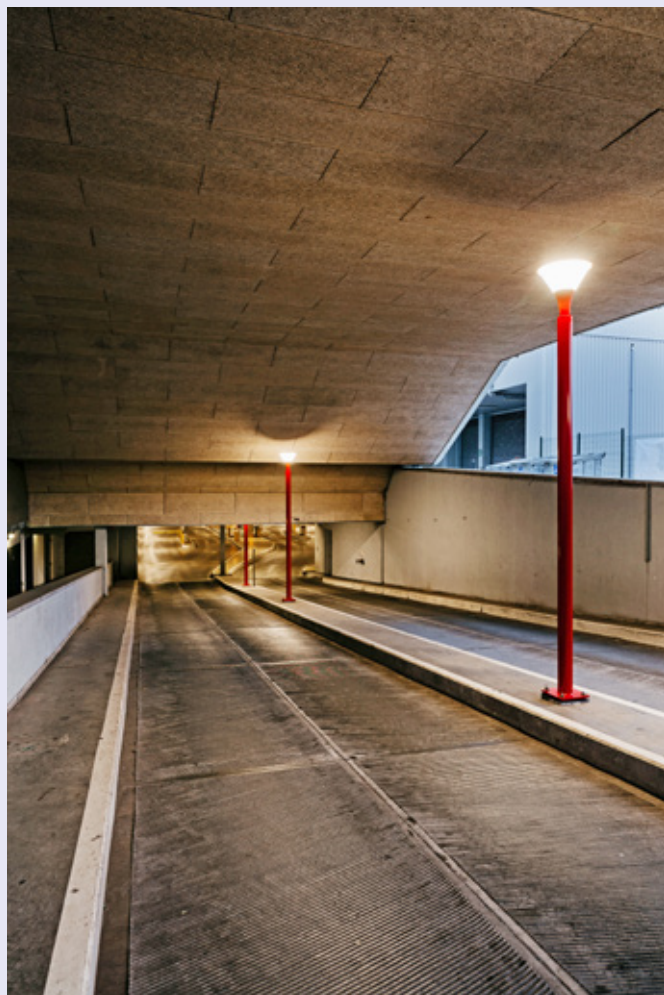

SIRIUS LED

Park and Street Luminaires



DESCRIPTION: Pole-mounted LED park luminaire
Light distribution type: direct
Optical system: lenses, polycarbonate diffuser, impact resistant
Housing: aluminium
Colour: light grey, RAL9006

GENERAL DATA: **Mains voltage:** 220-240V, 0/50-60Hz
LED lifetime, h: 50000/L80B10
SDCM: 5
Protection class IEC: I
Ingress protection code: IP66
Mechanical impact resistance: IK08
Operating temperature range, °C: ta -25...+40

INSTALLATION: With three screws on pole Ø60mm. Push-in terminal, 3x2x2.5mm²

ENVIRONMENT: Outdoor

APPLICATION: Park, public space

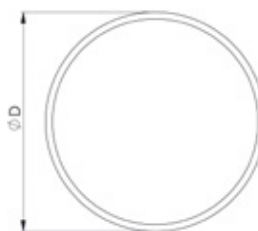
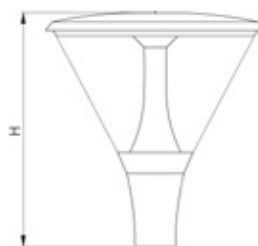

PRODUCT	DIAMETER, mm	HEIGHT, mm	LUMINAIRE OUTPUT*, lm	SYSTEM POWER*, W	SYSTEM EFFICACY*, lm/W	CRI	CCT*, K	WEIGHT, kg
Sirius LED1x5300 J674 T840	500	523	5275	39,3	134	80+	4000	9,0
Sirius LED1x7400 J675 T840	500	523	7394	58,3	127	80+	4000	9,0
Sirius LED1x9350 J708 T840	500	523	9328	78,1	119	80+	4000	9,0

*Tolerance range for optical and electrical data: ±10%. Values apply to an ambient temperature of 25°C. NORTHCLIFFE LIGHTING is constantly developing and improving its products. The right is reserved to change any product specifications without prior notification

OPTIONS AVAILABLE ON REQUEST:

LED	CONTROL GEAR	CONNECTION
T830	DALI	CBF3x1.5-N m ¹
T840	ADIM	CBF5x1.5-N m ¹

¹ Please specify the length of outgoing cable before placing an order

STANDARD

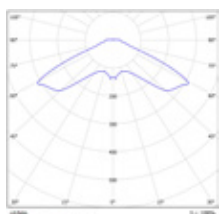

SEGIN LED

Park and Street Luminaires



DESCRIPTION: Pole-mounted LED park luminaire
Light distribution type: direct
Optical system: lenses, tempered glass diffuser, impact resistant
Housing: aluminium
Colour: black grey, RAL7021

GENERAL DATA: Mains voltage: 220-240V, 0/50-60Hz
 LED lifetime, h: 100000/L90B10
 SDCM: 3
 Protection class IEC: I (II optional)
 Ingress protection code: IP65
 Mechanical impact resistance: IK08
 Operating temperature range, °C: ta -25...+40

INSTALLATION: With three screws on pole Ø60mm. Push-in terminal, 3x2x2.5mm²

ENVIRONMENT: Outdoor

APPLICATION: Parking area, park, public space

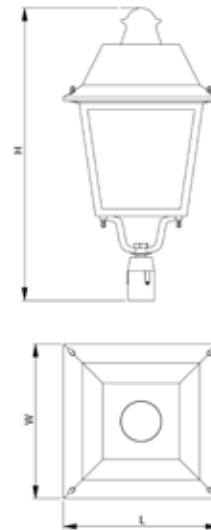

PRODUCT	LENGTH, mm	WIDTH, mm	HEIGHT, mm	LUMINAIRE OUTPUT*, lm	SYSTEM POWER*, W	SYSTEM EFFICACY*, lm/W	CRI	CCT*, K	WEIGHT, kg
Segin LED1x4350 E941 T740 LS140	425	425	816	4451	34,0	131	70+	4000	8,2
Segin LED1x5400 E942 T740 LS140	425	425	816	5557	44,3	125	70+	4000	8,2
Segin LED1x6500 E943 T740 LS140	425	425	816	6677	51,0	131	70+	4000	8,2
Segin LED1x8150 E944 T740 LS140	425	425	816	8335	65,8	127	70+	4000	8,2

*Tolerance range for optical and electrical data: ±10%. Values apply to an ambient temperature of 25°C. NORTHCLIFFE LIGHTING is constantly developing and improving its products. The right is reserved to change any product specifications without prior notification

OPTIONS AVAILABLE ON REQUEST:

LED	REFLECTOR AND OPTICS	CONTROL GEAR	SENSORS	PROTECTION	COLOUR
T730	LS140	DALI	PCA	Tmin-40C	RAL
T740	LSM1	ADIM		II	
T750	LSS1				

LS140

LSM1

LSS1

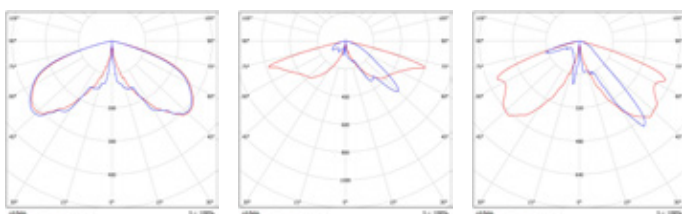



SQUALL LED

Park and Street Luminaires



DESCRIPTION: Pole-mounted LED park luminaire
Light distribution type: direct
Optical system: lenses, tempered glass diffuser, impact resistant
Housing: aluminium
Colour: black grey, RAL7021

GENERAL DATA: Mains voltage: 220-240V, 0/50-60Hz
LED lifetime, h: 100000/L90B10
SDCM: 3
Protection class IEC: I (II optional)
Ingress protection code: IP66
Mechanical impact resistance: IK08
Operating temperature range, °C: ta -25...+40 / ta -40...+40

INSTALLATION: With four screws on poles Ø60mm. Push-in terminal, 3x2x2.5mm²

ENVIRONMENT: Outdoor

APPLICATION: Parking area, park, public space, street

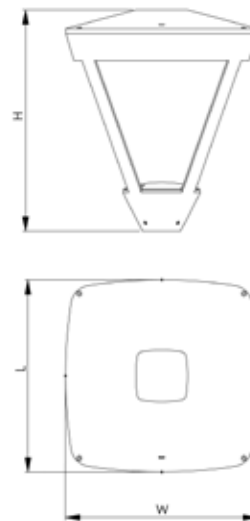

PRODUCT	LENGTH, mm	WIDTH, mm	HEIGHT, mm	LUMINAIRE OUTPUT*, lm	SYSTEM POWER*, W	SYSTEM EFFICACY*, lm/W	CRI	CCT*, K	WEIGHT, kg
Squall LED1x5350 E946 T740 LS140	475	475	535	5468	43,3	126	70+	4000	12,0
Squall LED1x6150 E947 T740 LS140	475	475	535	6321	51,0	124	70+	4000	12,0
Squall LED1x8200 E948 T740 LS140 Tmin-40C	475	475	535	8427	68,7	123	70+	4000	12,0
Squall LED1x10250 E949 T740 LS140 Tmin-40C	475	475	535	10521	87,7	120	70+	4000	12,0

*Tolerance range for optical and electrical data: ±10%. Values apply to an ambient temperature of 25°C. NORTHCLIFFE LIGHTING is constantly developing and improving its products. The right is reserved to change any product specifications without prior notification

OPTIONS AVAILABLE ON REQUEST:

LED	REFLECTOR AND OPTICS	CONTROL GEAR	SENSORS	PROTECTION	COLOUR
T730	LS140	DALI	PCA ¹	Tmin-40C	RAL
T740	LSM1	ADIM		II	
T750	LSS1				

¹ With PCA option luminaire operating temperature range starts from -25°C

LS140

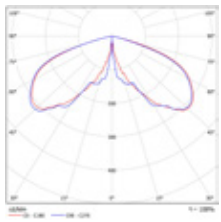

LSM1

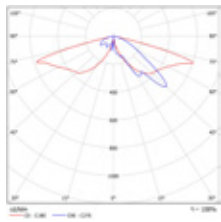

LSS1

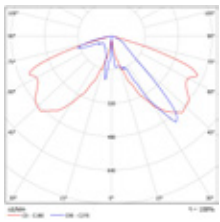

SARGAS LED

Park and Street Luminaires



DESCRIPTION: Pole-mounted LED park luminaire
Light distribution type: direct
Optical system: lenses, tempered glass diffuser, impact resistant
Housing: aluminium
Colour: light grey, RAL9006

GENERAL DATA: Mains voltage: 220-240V, 0/50-60Hz
 LED lifetime, h: 100000/L90B10
 SDCM: 5
 Protection class IEC: I
 Ingress protection code: IP66
 Mechanical impact resistance: IK08
 Operating temperature range, °C: ta
 -40...+40

INSTALLATION: With two screws on poles Ø60mm. Cable, 3.0m, 3x0.75mm²

ENVIRONMENT: Outdoor

APPLICATION: Park, public space

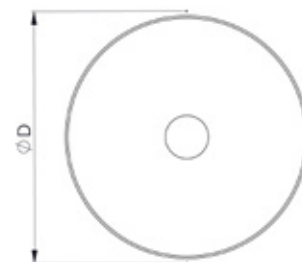
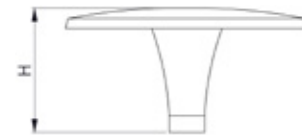

PRODUCT	DIAMETER, mm	HEIGHT, mm	LUMINAIRE OUTPUT*, lm	SYSTEM POWER*, W	SYSTEM EFFICACY*, lm/W	CRI	CCT*, K	WEIGHT, kg
Sargas LED1x5050 J455 T740 LS140	500	235	5009	34,3	146	70+	4000	10,0
Sargas LED1x7100 J456 T740 LS140	500	235	7073	48,7	145	70+	4000	10,0
Sargas LED1x9700 J457 T740 LS140	500	235	9663	68,0	142	70+	4000	10,0

*Tolerance range for optical and electrical data: ±10%. Values apply to an ambient temperature of 25°C. NORTHCLIFFE LIGHTING is constantly developing and improving its products. The right is reserved to change any product specifications without prior notification

OPTIONS AVAILABLE ON REQUEST:

LED	COVERS	CONTROL GEAR	SENSORS	PROTECTION	COLOUR
T730	SHADE	DALI	PCA	II	RAL
T740		ADIM			

LS140

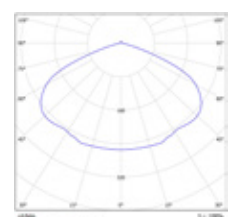



POLE LED

Park and Street Luminaires



DESCRIPTION: Pole shaped ground mounted LED luminaire
Light distribution type: direct
Optical system: lenses, clear polycarbonate diffuser, impact resistant
Housing: aluminium
Colour: dark grey, RAL7043

GENERAL DATA: **Mains voltage:** 220-240V, 0/50-60Hz
LED lifetime, h: 100000/L90B10
SDCM: 5
Protection class IEC: I
Ingress protection code: IP66
Mechanical impact resistance: IK08
Operating temperature range, °C: ta -25...+40

INSTALLATION: On the ground. Screw terminal, 3x1x1.5mm²

ENVIRONMENT: Outdoor

APPLICATION: Park, public space

PRODUCT	DIAMETER, mm	HEIGHT, mm	LUMINAIRE OUTPUT*, lm	SYSTEM POWER*, W	SYSTEM EFFICACY*, lm/W	CRI	CCT*, K	WEIGHT, kg
Pole LED1x5000 J673 T740 LS140	168	3500	5000	50,0	100	70+	4000	31,0
Pole LED1x5000 J673 T740 LSM1	168	3500	5000	50,0	100	70+	4000	31,0

*Tolerance range for optical and electrical data: ±10%. Values apply to an ambient temperature of 25°C. NORTHCLIFFE LIGHTING is constantly developing and improving its products. The right is reserved to change any product specifications without prior notification

OPTIONS AVAILABLE ON REQUEST:

LED	REFLECTOR AND OPTICS	CONTROL GEAR
T730	LS140	DALI
T740	LSM1	

LS140

LSM1

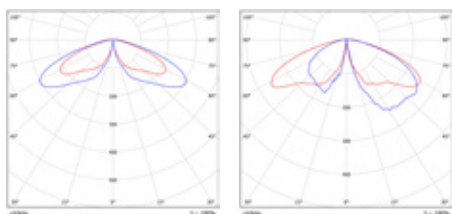



ALKES A LED

Park and Street Luminaires



DESCRIPTION: Pole-mounted LED street luminaire
Light distribution type: direct
Optical system: lenses, tempered glass diffuser, impact resistant
Housing: aluminium
Colour: black grey, RAL7021

GENERAL DATA: Mains voltage: 220-240V, 0/50-60Hz
 LED lifetime, h: 100000/L90B10
 SDCM: 5
 Protection class IEC: I
 Ingress protection code: IP66
 Mechanical impact resistance: IK08
 Operating temperature range, °C: ta -40...+40

INSTALLATION: With two screws on Ø60mm horizontal or vertical pole, on the wall (mounting bracket to be ordered separately). Adjustable installation angles: on horizontal pole: +/- 90 degrees, on vertical pole: + 90 degrees. Cable, 3.0m, 3x0.75mm²

ENVIRONMENT: Outdoor

APPLICATION: Parking area, public space, street

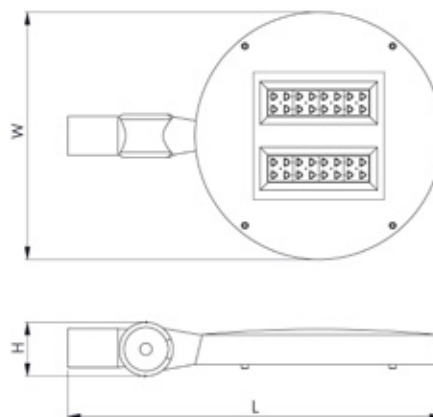

PRODUCT	LENGTH, mm	WIDTH, mm	HEIGHT, mm	LUMINAIRE OUTPUT*, lm	SYSTEM POWER*, W	SYSTEM EFFICACY*, lm/W	CRI	CCT*, K	WEIGHT, kg
Alkes A LED1x5850 J458 T740 LSM1	672	490	91	5820	36,2	161	70+	4000	9,0
Alkes A LED1x7950 J459 T740 LSM1	672	490	91	7923	51,0	155	70+	4000	9,0
Alkes A LED1x9900 J460 T740 LSM1	672	490	91	9891	67,2	147	70+	4000	9,0
Alkes A LED1x11300 J461 T740 LSM1	672	490	91	11255	78,4	144	70+	4000	9,0

*Tolerance range for optical and electrical data: ±10%. Values apply to an ambient temperature of 25°C. NORTHCLIFFE LIGHTING is constantly developing and improving its products. The right is reserved to change any product specifications without prior notification

AVAILABLE ACCESSORIES:



Product: WALL MTG bracket (Street LED D60mm 10° P7021S)
Description: Bracket for street luminaire installation onto wall, pole diameter D60mm, 10° angle, dark grey RAL7021S, 1pcs

OPTIONS AVAILABLE ON REQUEST:

LED	REFLECTOR AND OPTICS	CONTROL GEAR	CONNECTION	PROTECTION	COLOUR
T730	LS140	DALI	CBF3x1.5-N m ¹	II	RAL
T740	LSM1	ADIM	CBF5x1.5-N m ¹		
	LSM2				
	LSS1				
	LSS2				
	LSPR				
	LSPL				

1 Please specify the length of outgoing cable before placing an order

LS140

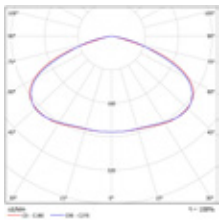

LSM1

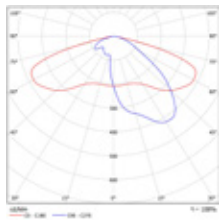

LSM2

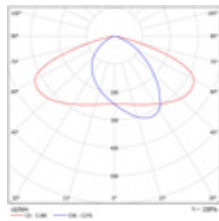

LSS1

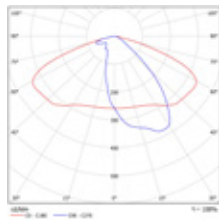

LSS2

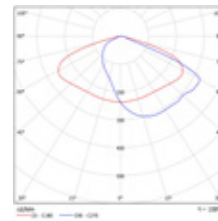

LSPR

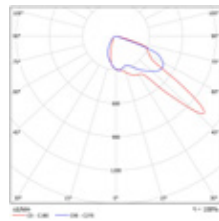

LSPL

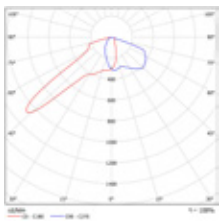

AUVA LED

Park and Street Luminaires



DESCRIPTION: Pole-mounted LED street luminaire
Light distribution type: direct
Optical system: lenses, tempered glass diffuser, impact resistant
Housing: aluminium
Colour: light grey, RAL7035; dark grey, RAL7022S

GENERAL DATA: Mains voltage: 220-240V, 0/50/60Hz / 50-60Hz
 LED lifetime, h: 100000/L90B10
 SDCM: 3
 Protection class IEC: I (II optional)
 Ingress protection code: IP66
 Mechanical impact resistance: IK09
 Operating temperature range, °C: ta -40...+40 (J001-J012 ta -25...+40)

INSTALLATION: With two screws on Ø60mm horizontal or vertical pole, on the wall (mounting bracket to be ordered separately). Adjustable installation angles: on horizontal pole: +/- 15 degrees, on vertical pole: +/- 15 degrees. Screw terminal, 3x1x2.5mm²

ENVIRONMENT: Outdoor

APPLICATION: Parking area, public space, street

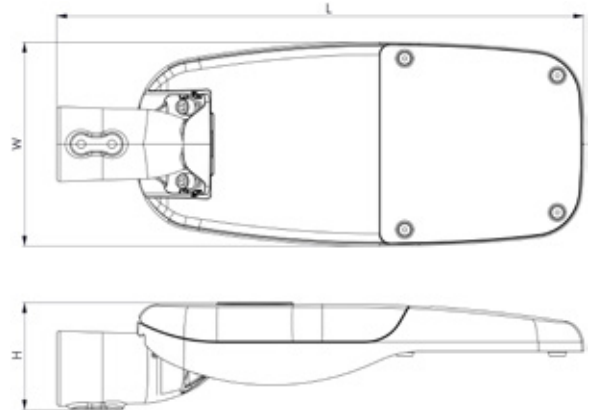

PRODUCT	LENGTH, mm	WIDTH, mm	HEIGHT, mm	LUMINAIRE OUTPUT*, lm	SYSTEM POWER*, W	SYSTEM EFFICACY*, lm/W	CRI	CCT*, K	WEIGHT, kg
Auva LED1x1900 J001 T740 LSM1	525	205	102	1992	12,5	159	70+	4000	3,5
Auva LED1x2250 J002 T740 LSM1	525	205	102	2351	15,2	155	70+	4000	3,5
Auva LED1x2600 J003 T740 LSM1	525	205	102	2720	17,4	156	70+	4000	3,5
Auva LED1x2900 J004 T740 LSM1	525	205	102	3055	20,1	152	70+	4000	3,5
Auva LED1x3250 J005 T740 LSM1	525	205	102	3407	22,6	151	70+	4000	3,5
Auva LED1x3700 J006 T740 LSM1	525	205	102	3891	26,7	146	70+	4000	3,5
Auva LED1x3800 J007 T740 LSM1	525	205	102	3985	24,0	166	70+	4000	3,5
Auva LED1x4500 J008 T740 LSM1	525	205	102	4701	29,1	162	70+	4000	3,5
Auva LED1x5200 J009 T740 LSM1	525	205	102	5439	34,0	160	70+	4000	3,5
Auva LED1x5800 J010 T740 LSM1	525	205	102	6111	39,2	156	70+	4000	3,5
Auva LED1x6450 J011 T740 LSM1	525	205	102	6814	44,6	153	70+	4000	3,5
Auva LED1x7350 J012 T740 LSM1	525	205	102	7781	52,7	148	70+	4000	3,5

PRODUCT	LENGTH, mm	WIDTH, mm	HEIGHT, mm	LUMINAIRE OUTPUT*, lm	SYSTEM POWER*, W	SYSTEM EFFICACY*, lm/W	CRI	CCT*, K	WEIGHT, kg
Auva LED1x5700 J013 T740 LSM1	525	250	102	5977	36,0	166	70+	4000	4,9
Auva LED1x6700 J014 T740 LSM1	525	250	102	7052	43,7	161	70+	4000	4,9
Auva LED1x7750 J015 T740 LSM1	525	250	102	8159	51,6	158	70+	4000	4,9
Auva LED1x8700 J016 T740 LSM1	525	250	102	9166	59,5	154	70+	4000	5,0
Auva LED1x9700 J017 T740 LSM1	525	250	102	10221	67,7	151	70+	4000	5,0
Auva LED1x11050 J018 T740 LSM1	525	250	102	11672	80,0	146	70+	4000	5,0
Auva LED1x7600 J019 T740 LSM1	625	288	102	7969	48,5	164	70+	4000	7,2
Auva LED1x8950 J020 T740 LSM1	625	288	102	9403	58,2	162	70+	4000	7,2
Auva LED1x10350 J021 T740 LSM1	625	288	102	10878	68,8	158	70+	4000	7,3
Auva LED1x11600 J022 T740 LSM1	625	288	102	12222	78,5	156	70+	4000	7,3
Auva LED1x12900 J023 T740 LSM1	625	288	102	13628	89,2	153	70+	4000	7,3
Auva LED1x14700 J024 T740 LSM1	625	288	102	15563	105,5	148	70+	4000	7,3
Auva LED1x11400 J025 T740 LSM1	625	288	102	11954	72,0	166	70+	4000	7,2
Auva LED1x13400 J026 T740 LSM1	625	288	102	14104	87,4	161	70+	4000	7,3
Auva LED1x15500 J027 T740 LSM1	625	288	102	16318	102,1	160	70+	4000	7,3
Auva LED1x17400 J028 T740 LSM1	625	288	102	18333	117,7	156	70+	4000	7,3
Auva LED1x19350 J029 T740 LSM1	625	288	102	20442	133,9	153	70+	4000	7,3
Auva LED1x15200 J031 T740 LSM1	776	320	102	15938	95,0	168	70+	4000	9,4
Auva LED1x17900 J032 T740 LSM1	776	320	102	18806	115,2	163	70+	4000	9,4
Auva LED1x20700 J033 T740 LSM1	776	320	102	21757	136,1	160	70+	4000	9,4
Auva LED1x23150 J034 T740 LSM1	776	320	102	24444	157,0	156	70+	4000	9,4
Auva LED1x25800 J035 T740 LSM1	776	320	102	27255	178,5	153	70+	4000	9,4

*Tolerance range for optical and electrical data: ±10%. Values apply to an ambient temperature of 25°C. NORTHCLIFFE LIGHTING is constantly developing and improving its products. The right is reserved to change any product specifications without prior notification

AVAILABLE ACCESSORIES:



Product: WALL MTG bracket (Street LED D60mm 10° P7035S)
Description: Bracket for street luminaire installation onto wall, pole diameter D60mm, 10° angle, light grey RAL7035S, 1pcs



Product: Pole adapter RAL7035S (D60 into D76mm)
Description: Console adapter from luminaire D60 to pole top D76 mm. Light grey, RAL7035S



Product: WALL MTG bracket (Street LED D60mm 10° P7022S)
Description: Bracket for street luminaire installation onto wall, pole diameter D60mm, 10° angle, dark grey RAL7022S, 1pcs



Product: Power supply connector - IP66/IP68, 3x1.5mm²
Description: Quick and easy to connect power supply and luminaire cables connector - IP66/IP68, 3x1.5mm², 450V/10A, 1pcs

OPTIONS AVAILABLE ON REQUEST:

LED	REFLECTOR AND OPTICS	CONTROL GEAR	SENSORS	CONNECTION	PROTECTION	COLOUR
T730	LSA1	DALI	PCA	CBF3x1.5-N m ¹	Tmin-40C ²	RAL
T740	LSA2	CLO		CBF5x1.5-N m ¹	10KV	
T750	LSM1	ADIM			II	
T757	LSM2	DALI NEMA5p			ETC	
T765	LSS1	DALI ZHAGA18				
T830	LSS2	DALI ZHAGA18 DOWN				
T840	LSPR	DALI 2xZHAGA18				
T850	LSPL					
T857	LS140					
T865						

- 1 Please specify the length of outgoing cable before placing an order
- 2 Tmin-40C option is applicable for models J001...J012

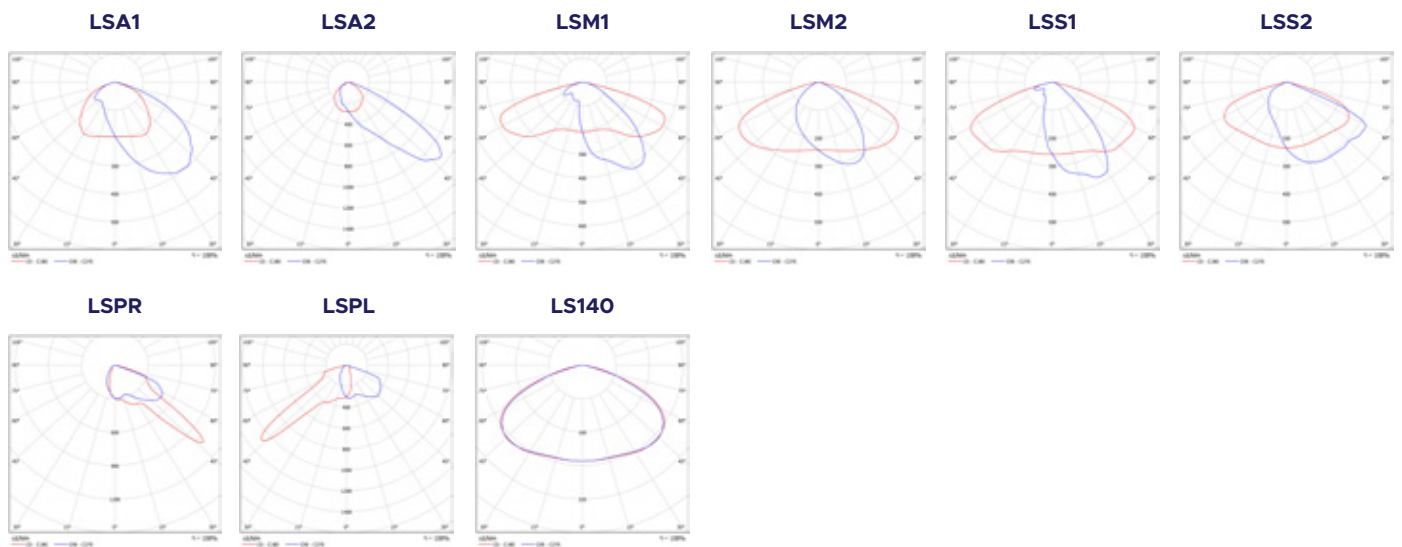

AVIOR LED

Park and Street Luminaires



DESCRIPTION: Pole-mounted LED street luminaire
Light distribution type: direct
Optical system: lenses, tempered glass diffuser, impact resistant
Housing: aluminium
Colour: light grey, RAL7035

GENERAL DATA: **Mains voltage:** 220-240V, 0/50-60Hz
LED lifetime, h: 100000/L90B10
SDCM: 3
Protection class IEC: I (II optional)
Ingress protection code: IP66
Mechanical impact resistance: IK09
Operating temperature range, °C: ta -25...+40 (J495 ta -40...+40)

INSTALLATION: With two screws on Ø60mm horizontal or vertical pole, on the wall (mounting bracket to be ordered separately). Adjustable installation angles: on horizontal pole: +/- 15 degrees, on vertical pole: +/- 15 degrees. Push-in terminal, 3x2x2.5mm²

ENVIRONMENT: Outdoor

APPLICATION: Parking area, public space, street

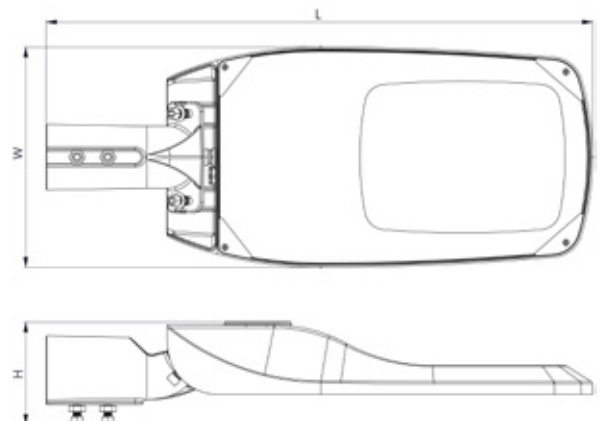

PRODUCT	LENGTH, mm	WIDTH, mm	HEIGHT, mm	LUMINAIRE OUTPUT*, lm	SYSTEM POWER*, W	SYSTEM EFFICACY*, lm/W	CRI	CCT*, K	WEIGHT, kg
Avior LED1x2850 J484 T740 LSM1	559	216	93	2988	18,2	164	70+	4000	3,8
Avior LED1x3350 J485 T740 LSM1	559	216	93	3526	22,1	160	70+	4000	3,8
Avior LED1x3900 J486 T740 LSM1	559	216	93	4079	25,8	158	70+	4000	3,8
Avior LED1x4350 J487 T740 LSM1	559	216	93	4583	29,8	154	70+	4000	3,8
Avior LED1x4850 J488 T740 LSM1	559	216	93	5110	33,5	153	70+	4000	3,8
Avior LED1x5550 J489 T740 LSM1	559	216	93	5836	39,6	147	70+	4000	3,8
Avior LED1x5700 J490 T740 LSM1	559	216	93	5977	35,6	168	70+	4000	3,8
Avior LED1x6700 J491 T740 LSM1	559	216	93	7052	43,2	163	70+	4000	3,8
Avior LED1x7750 J492 T740 LSM1	559	216	93	8159	51,0	160	70+	4000	3,8
Avior LED1x8700 J493 T740 LSM1	559	216	93	9166	58,9	156	70+	4000	3,8
Avior LED1x9700 J494 T740 LSM1	559	216	93	10221	66,2	154	70+	4000	3,8
Avior LED1x11050 J495 T740 LSM1	559	216	93	11672	80,0	146	70+	4000	3,8

*Tolerance range for optical and electrical data: ±10%. Values apply to an ambient temperature of 25°C. NORTHCLIFFE LIGHTING is constantly developing and improving its products. The right is reserved to change any product specifications without prior notification

AVAILABLE ACCESSORIES:



Product: WALL MTG bracket (Street LED D60mm 10° P7035S)
Description: Bracket for street luminaire installation onto wall, pole diameter D60mm, 10° angle, light grey RAL7035S, 1pcs



Product: Pole adapter RAL7035S (D60 into D76mm)
Description: Console adapter from luminaire D60 to pole top D76 mm. Light grey, RAL7035S



Product: WALL MTG bracket (Street LED D60mm 10° P7022S)
Description: Bracket for street luminaire installation onto wall, pole diameter D60mm, 10° angle, dark grey RAL7022S, 1pcs



Product: Power supply connector - IP66/IP68, 3x1.5mm²
Description: Quick and easy to connect power supply and luminaire cables connector - IP66/IP68, 3x1.5 mm², 450V/10A, 1pcs

OPTIONS AVAILABLE ON REQUEST:

LED	REFLECTOR AND OPTICS	CONTROL GEAR	SENSORS	CONNECTION	PROTECTION	COLOUR
T730	LSA1	DALI	PCA	CBF3x1.5-N m ¹	Tmin-40C ²	RAL
T740	LSA2	CLO		CBF5x1.5-N m ¹	10KV	
T750	LSM1	ADIM			II	
T757	LSM2	DALI ZHAGA18			ETC	
T765	LSS1	DALI NEMA5p				
T830	LSS2					
T840	LSPR					
T850	LSPL					
T857						
T865						

1 Please specify the length of outgoing cable before placing an order
2 Tmin-40C option is applicable for model J495

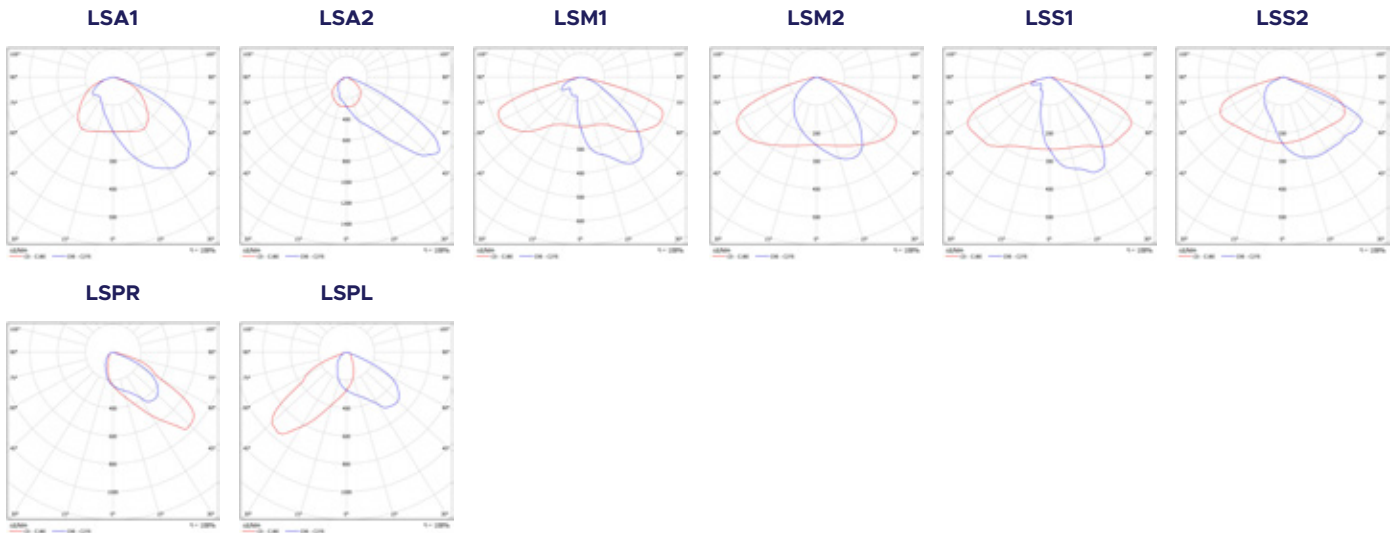

STAR B LED

Park and Street Luminaires



DESCRIPTION: Pole-mounted basic LED street luminaire
Light distribution type: direct
Optical system: polycarbonate asymmetric street optics, UV stabilized, impact resistant
Housing: aluminium
Colour: light grey, RAL7042

GENERAL DATA: Mains voltage: 220-240V, 50-60Hz
LED lifetime, h: 50000/L70B50
SDCM: 5
Protection class IEC: I
Ingress protection code: IP65
Mechanical impact resistance: IK08
Operating temperature range, °C: ta -20...+40

INSTALLATION: With two screws on Ø60mm horizontal or vertical pole, on the wall (mounting bracket to be ordered separately). Cable, 0.45m, 3x1.00mm²

ENVIRONMENT: Outdoor

APPLICATION: Parking area, public space

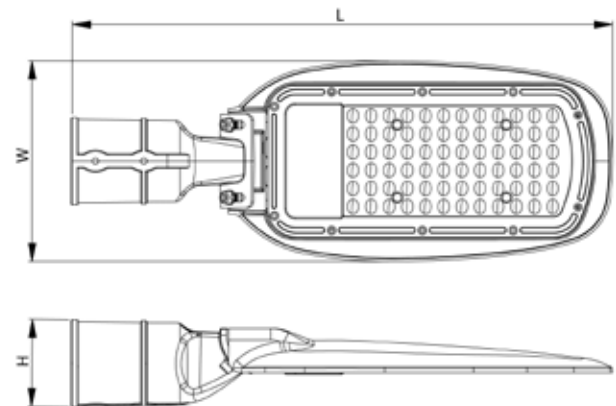

PRODUCT	LENGTH, mm	WIDTH, mm	HEIGHT, mm	LUMINAIRE OUTPUT*, lm	SYSTEM POWER*, W	SYSTEM EFFICACY*, lm/W	CRI	CCT*, K	WEIGHT, kg
Star B LED1x3600 H241 T840	447	166	72	3600	30,0	120	80+	4000	1,2
Star B LED1x5000 H212 T840	447	166	72	5500	50,0	110	80+	4000	1,0
Star B LED1x8400 H242 T840	545	225	72	8400	70,0	120	80+	4000	2,37

*Tolerance range for optical and electrical data: ±10%. Values apply to an ambient temperature of 25°C. NORTHCLIFFE LIGHTING is constantly developing and improving its products. The right is reserved to change any product specifications without prior notification

AVAILABLE ACCESSORIES:



Product: WALL MTG bracket (Street LED D60mm 10° P7042S)

Description: Bracket for street luminaire installation onto wall, pole diameter D60mm, 10° angle, light grey RAL7042S, 1pcs

Product: Power supply connector - IP66/IP68, 3x1.5mm²

Description: Quick and easy to connect power supply and luminaire cables connector - IP66/IP68, 3x1.5mm², 450V/10A, 1pcs

STANDARD

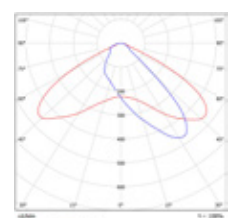

ALKES B LED

Park and Street Luminaires

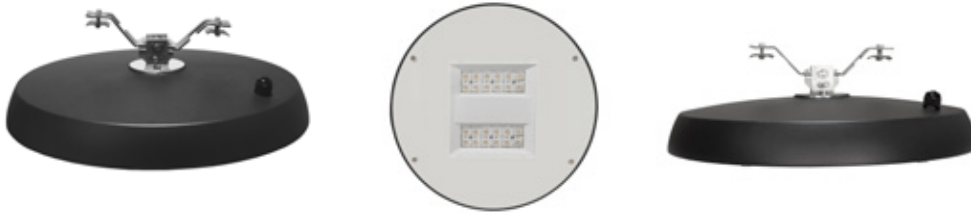
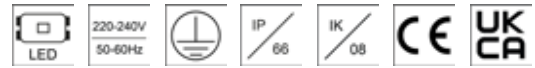

DESCRIPTION: **Suspended LED street luminaire**
Light distribution type: direct
Optical system: lenses, tempered glass diffuser, impact resistant
Housing: aluminium
Colour: black grey, RAL7021

GENERAL DATA: **Mains voltage:** 220-240V, 0/50-60Hz
LED lifetime, h: 100000/L90B10
SDCM: 5
Protection class IEC: I
Ingress protection code: IP66
Mechanical impact resistance: IK08
Operating temperature range, °C: ta -40...+40

INSTALLATION: With special bracket on Ø12mm horizontal line.
 Adjustable installation angles: on vertical plane: +/- 30 degrees, on horizontal plane: +/- 30 degrees. Push-in terminal, 3x2x2.5mm²

ENVIRONMENT: Outdoor

APPLICATION: Parking area, public space, street

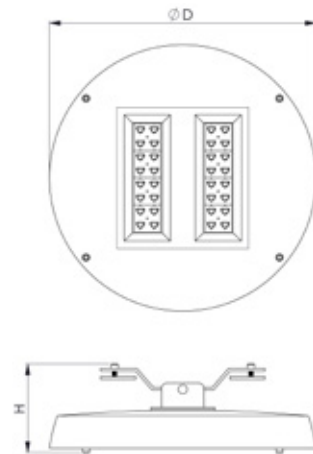

PRODUCT	DIAMETER, mm	HEIGHT, mm	LUMINAIRE OUTPUT*, lm	SYSTEM POWER*, W	SYSTEM EFFICACY*, lm/W	CRI	CCT*, K	WEIGHT, kg
Alkes B LED1x5850 J462 T740 LS140	490	130	5820	36,2	161	70+	4000	8,3
Alkes B LED1x7950 J463 T740 LS140	490	130	7923	51,0	155	70+	4000	8,3
Alkes B LED1x9900 J464 T740 LS140	490	130	9891	67,2	147	70+	4000	8,3
Alkes B LED1x11300 J465 T740 LS140	490	130	11255	78,4	144	70+	4000	8,3

*Tolerance range for optical and electrical data: ±10%. Values apply to an ambient temperature of 25°C. NORTHCLIFFE LIGHTING is constantly developing and improving its products. The right is reserved to change any product specifications without prior notification

OPTIONS AVAILABLE ON REQUEST:

LED	REFLECTOR AND OPTICS	CONTROL GEAR	CONNECTION	PROTECTION	COLOUR
T730	LS90	DALI	CBF3x1.5-N m ¹	II	RAL
T740		ADIM	CBF5x1.5-N m ¹		

1 Please specify the length of outgoing cable before placing an order

LS90

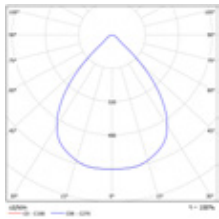

LS140

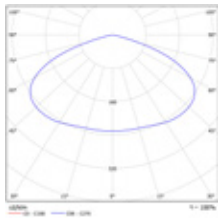

LED STRIPS AND PROFILES

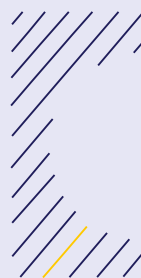

ALU PROFILE SET S1208

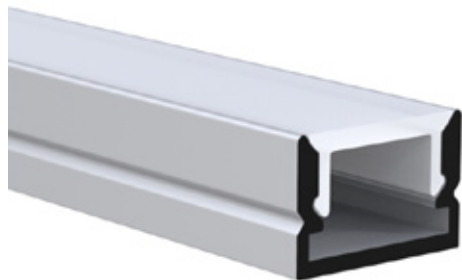

LED Strips and Profiles

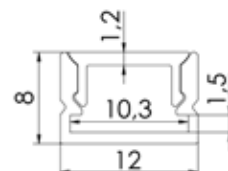
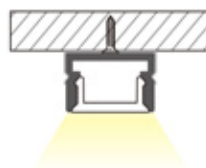

DESCRIPTION: Surface aluminium profile for LED strip system

Light distribution type: direct

Optical system: opal PC diffuser

Housing: aluminium

Colour: silver

INSTALLATION: Surface-mounted (end caps and mounting brackets included)

ENVIRONMENT: Indoor

PRODUCT	LENGTH, mm	WIDTH, mm	HEIGHT, mm	COLOUR
Alu profile set S1208 SILVER 2m	2000	12,0	8,0	Silver
Alu profile set S1208 SILVER 3m	3000	12,0	8,0	Silver

AVAILABLE ACCESSORIES:



Product: End CAP - S1208 S

Description: Silver end cap

Product: END CAP with hole - S1208 S

Description: Silver end cap with hole



Product: MNT BRACKET - S1208 M

Description: Metallic mounting bracket



ALU PROFILE SET S1709

LED Strips and Profiles

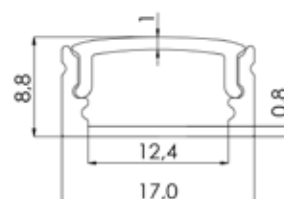
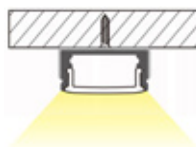

DESCRIPTION: Surface aluminium profile for LED strip system

Light distribution type: direct

Optical system: opal PC diffuser

Housing: aluminium

Colour: silver; black

INSTALLATION: Surface-mounted (end caps and mounting brackets included)

ENVIRONMENT: Indoor

PRODUCT	LENGTH, mm	WIDTH, mm	HEIGHT, mm	COLOUR
Alu profile set S1709 SILVER 2m	2000	17,0	8,8	Silver
Alu profile set S1709 SILVER 3m	3000	17,0	8,8	Silver
Alu profile set S1709 BLACK 2m	2000	17,0	8,8	Black
Alu profile set S1709 BLACK 3m	3000	17,0	8,8	Black

AVAILABLE ACCESSORIES:



Product: End CAP - S1709 S

Description: Silver end cap

Product: END CAP with hole - S1709 S

Description: Silver end cap with hole

Product: End CAP - S1709 B

Description: Black end cap

Product: END CAP with hole - S1709 B

Description: Black end cap with hole



Product: MNT BRACKET - S1709 M

Description: Metallic mounting bracket



Product: DIFFUSER - S1709 B 2m

Description: Black diffuser, 2m

Product: DIFFUSER - S1709 B 3m

Description: Black diffuser, 3m

ALU PROFILE SET S1715

LED Strips and Profiles

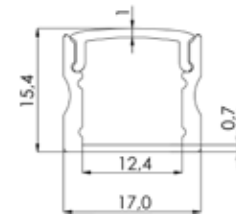
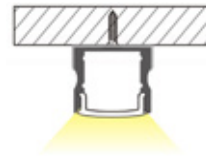





DESCRIPTION: Surface aluminium profile for LED strip system
Light distribution type: direct
Optical system: opal PC diffuser
Housing: aluminium
Colour: silver; black

INSTALLATION: Surface-mounted (end caps and mounting brackets included)

ENVIRONMENT: Indoor

PRODUCT	LENGTH, mm	WIDTH, mm	HEIGHT, mm	COLOUR
Alu profile set S1715 SILVER 2m	2000	17,0	15,4	Silver
Alu profile set S1715 SILVER 3m	3000	17,0	15,4	Silver
Alu profile set S1715 BLACK 2m	2000	17,0	15,4	Black
Alu profile set S1715 BLACK 3m	3000	17,0	15,4	Black

AVAILABLE ACCESSORIES:

-  **Product:** End CAP - S1715 S
Description: Silver end cap
-  **Product:** END CAP with hole - S1715 S
Description: Silver end cap with hole
-  **Product:** End CAP - S1715 B
Description: Black end cap
-  **Product:** END CAP with hole - S1715 B
Description: Black end cap with hole



- Product:** MNT BRACKET - S1715 M
Description: Metallic mounting bracket
- Product:** DIFFUSER - S1715 B 2m
Description: Black diffuser, 2m
- Product:** DIFFUSER - S1715 B 3m
Description: Black diffuser, 3m

ALU PROFILE SET S1713

LED Strips and Profiles

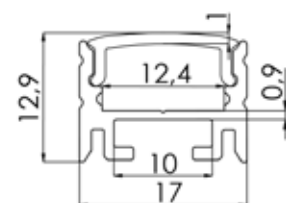
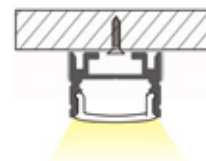



DESCRIPTION: Surface aluminium profile for LED strip system
Light distribution type: direct
Optical system: opal PC diffuser
Housing: aluminium
Colour: silver

INSTALLATION: Surface-mounted (end caps and mounting brackets included)

ENVIRONMENT: Indoor

PRODUCT	LENGTH, mm	WIDTH, mm	HEIGHT, mm	COLOUR
Alu profile set S1713 SILVER 2m	2000	17,0	12,9	Silver
Alu profile set S1713 SILVER 3m	3000	17,0	12,9	Silver

AVAILABLE ACCESSORIES:

-  **Product:** End CAP - S1713 S
Description: Silver end cap
-  **Product:** END CAP with hole - S1713 S
Description: Silver end cap with hole



- Product:** MNT BRACKET - S1713 M
Description: Metallic mounting bracket

ALU PROFILE SET R2409



LED Strips and Profiles

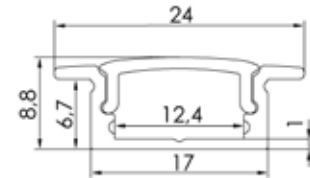
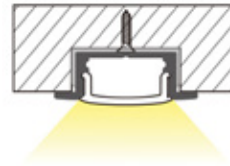

DESCRIPTION: Recessed aluminium profile for LED strip system
Light distribution type: direct
Optical system: opal PC diffuser
Housing: aluminium
Colour: silver; black

INSTALLATION: Recessed-mounted (end caps and mounting brackets included)

ENVIRONMENT: Indoor

PRODUCT	LENGTH, mm	WIDTH, mm	HEIGHT, mm	COLOUR
Alu profile set R2409 SILVER 2m	2000	24,0	8,8	Silver
Alu profile set R2409 SILVER 3m	3000	24,0	8,8	Silver
Alu profile set R2409 BLACK 2m	2000	24,0	8,8	Black
Alu profile set R2409 BLACK 3m	3000	24,0	8,8	Black

AVAILABLE ACCESSORIES:



Product: End CAP - R2409 S
Description: Silver end cap

Product: END CAP with hole - R2409 S
Description: Silver end cap with hole

Product: End CAP - R2409 B
Description: Black end cap

Product: END CAP with hole - R2409 B
Description: Black end cap with hole



Product: MNT BRACKET- R2409 M
Description: Metallic mounting bracket



Product: DIFFUSER - R2409 B 2m
Description: Black diffuser, 2m

Product: DIFFUSER - R2409 B 3m
Description: Black diffuser, 3m



ALU PROFILE SET R2515

LED Strips and Profiles

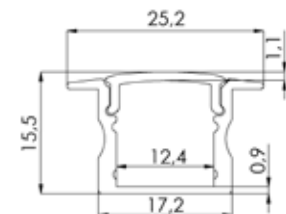
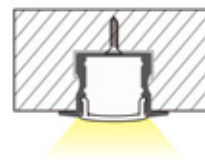

DESCRIPTION: Recessed aluminium profile for LED strip system
Light distribution type: direct
Optical system: opal PC diffuser
Housing: aluminium
Colour: silver

INSTALLATION: Recessed-mounted (end caps and mounting brackets included)

ENVIRONMENT: Indoor

PRODUCT	LENGTH, mm	WIDTH, mm	HEIGHT, mm	COLOUR
Alu profile set R2515 SILVER 2m	2000	25,2	15,5	Silver
Alu profile set R2515 SILVER 3m	3000	25,2	15,5	Silver

AVAILABLE ACCESSORIES:



Product: End CAP - R2515 S
Description: Silver end cap

Product: END CAP with hole - R2515 S
Description: Silver end cap with hole



Product: MNT BRACKET- R2515 M
Description: Metallic mounting bracket

ALU PROFILE SET R2519

LED Strips and Profiles

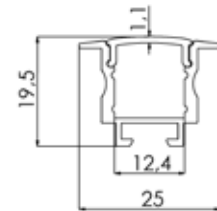
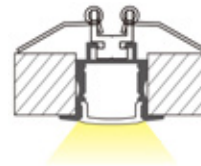

DESCRIPTION: Recessed aluminium profile for LED strip system
Light distribution type: direct
Optical system: opal PC diffuser
Housing: aluminium
Colour: silver

INSTALLATION: In ceilings with cut-out openings (end caps and mounting clips included)

ENVIRONMENT: Indoor

PRODUCT	LENGTH, mm	WIDTH, mm	HEIGHT, mm	COLOUR
Alu profile set R2519 SILVER 2m	2000	25,0	19,5	Silver
Alu profile set R2519 SILVER 3m	3000	25,0	19,5	Silver

AVAILABLE ACCESSORIES:



Product: End CAP - R2519 S
Description: Silver end cap

Product: END CAP with hole - R2519 S
Description: Silver end cap with hole



Product: MNT CLIP - R2519 M
Description: Metallic mounting clip



ALU PROFILE SET S2623

LED Strips and Profiles

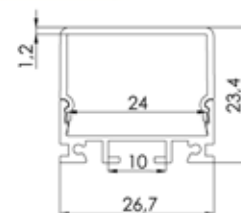
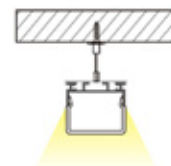
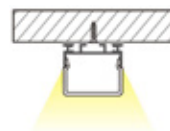

DESCRIPTION: Surface aluminium profile for LED strip system
Light distribution type: direct
Optical system: opal PC diffuser
Housing: aluminium
Colour: silver

INSTALLATION: Surface-mounted or suspended (end caps and mounting brackets included)

ENVIRONMENT: Indoor

PRODUCT	LENGTH, mm	WIDTH, mm	HEIGHT, mm	COLOUR
Alu profile set S2623 SILVER 2m	2000	26,7	23,4	Silver
Alu profile set S2623 SILVER 3m	3000	26,7	23,4	Silver

AVAILABLE ACCESSORIES:



Product: End CAP - S2623 S
Description: Silver end cap

Product: END CAP with hole - S2623 S
Description: Silver end cap with hole



Product: MNT BRACKET- S2623 M
Description: Metallic mounting bracket



Product: SUS WIRE - S2623 M
Description: Suspension wire

ALU PROFILE SET S2036

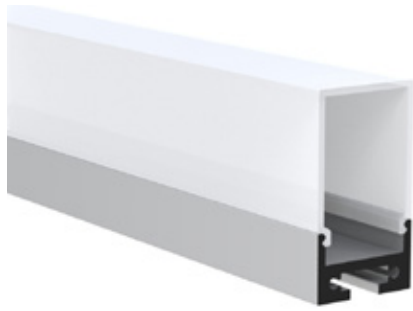

LED Strips and Profiles

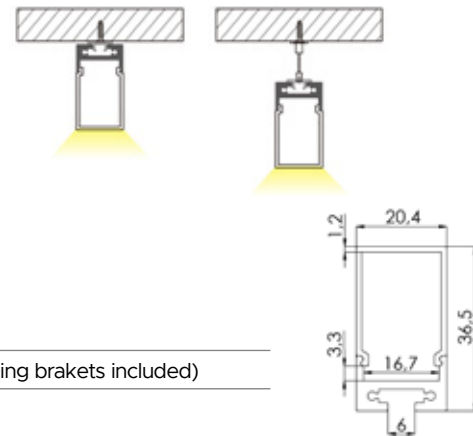

DESCRIPTION: Surface aluminium profile for LED strip system
Light distribution type: direct
Optical system: opal PC diffuser
Housing: aluminium
Colour: silver

INSTALLATION: Surface-mounted or suspended (end caps and mounting brackets included)

ENVIRONMENT: Indoor

PRODUCT	LENGTH, mm	WIDTH, mm	HEIGHT, mm	COLOUR
Alu profile set S2036 SILVER 2m	2000	20,4	36,5	Silver
Alu profile set S2036 SILVER 3m	3000	20,4	36,5	Silver

AVAILABLE ACCESSORIES:



Product: End CAP - S2036 S
Description: Silver end cap
Product: END CAP with hole - S2036 S
Description: Silver end cap with hole



Product: MNT BRACKET - S2036 M
Description: Metallic mounting bracket
Product: SUS WIRE - S2036 M
Description: Suspension wire

ALU PROFILE SET S2020



LED Strips and Profiles

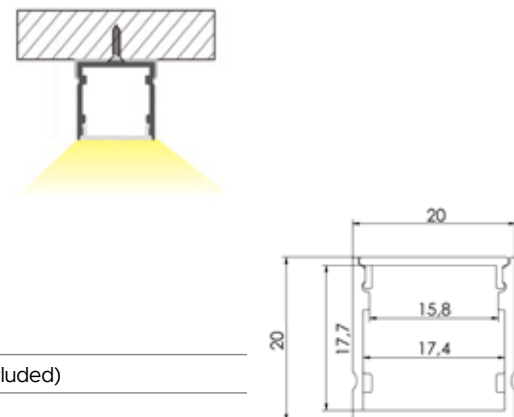

DESCRIPTION: Surface aluminium profile for LED strip system
Light distribution type: direct
Optical system: opal PC diffuser
Housing: aluminium
Colour: silver

INSTALLATION: Surface-mounted (end caps and mounting brackets included)

ENVIRONMENT: Indoor

PRODUCT	LENGTH, mm	WIDTH, mm	HEIGHT, mm	COLOUR
Alu profile set S2020 SILVER 2m	2000	20,0	20,0	Silver
Alu profile set S2020 SILVER 3m	3000	20,0	20,0	Silver

AVAILABLE ACCESSORIES:



Product: End CAP - S2020 S
Description: Silver end cap
Product: END CAP with hole - S2020 S
Description: Silver end cap with hole



Product: MNT BRACKET- S2020 M
Description: Metallic mounting bracket

ALU PROFILE SET S2525



LED Strips and Profiles

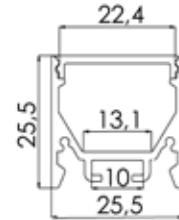
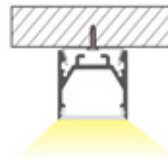

DESCRIPTION: Surface aluminium profile for LED strip system
Light distribution type: direct
Optical system: opal PC diffuser
Housing: aluminium
Colour: silver

INSTALLATION: Surface-mounted (end caps and mounting brackets included)

ENVIRONMENT: Indoor

PRODUCT	LENGTH, mm	WIDTH, mm	HEIGHT, mm	COLOUR
Alu profile set S2525 SILVER 2m	2000	25,5	25,5	Silver
Alu profile set S2525 SILVER 3m	3000	25,5	25,5	Silver

AVAILABLE ACCESSORIES:



Product: End CAP - S2525 S
Description: Silver end cap

Product: END CAP with hole - S2525 S
Description: Silver end cap with hole



Product: JOINT I - S2525 M
Description: I joint accessory



Product: JOINT L - S2525 M
Description: L joint accessory



Product: MNT BRACKET- S2525 M
Description: Metallic mounting bracket



Product: JOINT T - S2525 M
Description: T joint accessory



Product: JOINT X - S2525 M
Description: X joint accessory



Product: JOINT C - S2525 M
Description: Corner joint accessory

ALU PROFILE SET S3020



LED Strips and Profiles

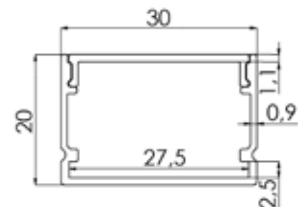
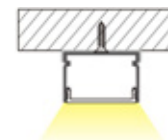

DESCRIPTION: Surface aluminium profile for LED strip system
Light distribution type: direct
Optical system: opal PC diffuser
Housing: aluminium
Colour: silver

INSTALLATION: Surface-mounted (end caps and mounting brackets included)

ENVIRONMENT: Indoor

PRODUCT	LENGTH, mm	WIDTH, mm	HEIGHT, mm	COLOUR
Alu profile set S3020 SILVER 2m	2000	30,0	20,0	Silver
Alu profile set S3020 SILVER 3m	3000	30,0	20,0	Silver

AVAILABLE ACCESSORIES:



Product: End CAP - S3020 S
Description: Silver end cap

Product: END CAP with hole - S3020 S
Description: Silver end cap with hole



Product: MNT BRACKET - S3020 M
Description: Metallic mounting bracket

ALU PROFILE SET U2535

LED Strips and Profiles

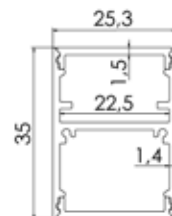
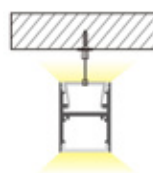

DESCRIPTION: Suspended aluminium profile for LED strip system with up and down light distribution
Light distribution type: direct/indirect
Optical system: opal PC diffuser
Housing: aluminium
Colour: silver

INSTALLATION: Suspended (end caps and suspension brackets included)

ENVIRONMENT: Indoor

PRODUCT	LENGTH, mm	WIDTH, mm	HEIGHT, mm	COLOUR
Alu profile set U2535 SILVER 2m	2000	25,3	35,0	Silver
Alu profile set U2535 SILVER 3m	3000	25,3	35,0	Silver

AVAILABLE ACCESSORIES:



Product: End CAP - U2535 S
Description: Silver end cap
Product: END CAP with hole - U2535 S
Description: Silver end cap with hole



Product: MNT BRACKET - U2535 M
Description: Metallic mounting bracket
Product: SUS WIRE - U2535 M
Description: Suspension wire

ALU PROFILE SET S3535M

LED Strips and Profiles

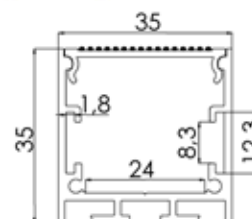
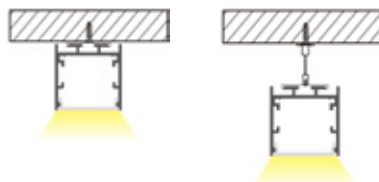

DESCRIPTION: Surface aluminium profile for LED strip system
Light distribution type: direct
Optical system: clear microprismatic diffuser, UGR<19
Housing: aluminium
Colour: silver

INSTALLATION: Surface-mounted or suspended (end caps and mounting brackets included)

ENVIRONMENT: Indoor

PRODUCT	LENGTH, mm	WIDTH, mm	HEIGHT, mm	COLOUR
Alu profile set S3535M SILVER 2m	2000	35,0	35,0	Silver
Alu profile set S3535M SILVER 3m	3000	35,0	35,0	Silver

AVAILABLE ACCESSORIES:



Product: End CAP - S3535M S
Description: Silver end cap
Product: END CAP with hole - S3535M S
Description: Silver end cap with hole
Product: JOINT I - S3535M M
Description: I joint accessory
Product: JOINT L - S3535M M
Description: L joint accessory



Product: MNT BRACKET - S3535M M
Description: Metallic mounting bracket
Product: SUS WIRE - S3535M M
Description: Suspension wire

ALU PROFILE SET S35350



LED Strips and Profiles

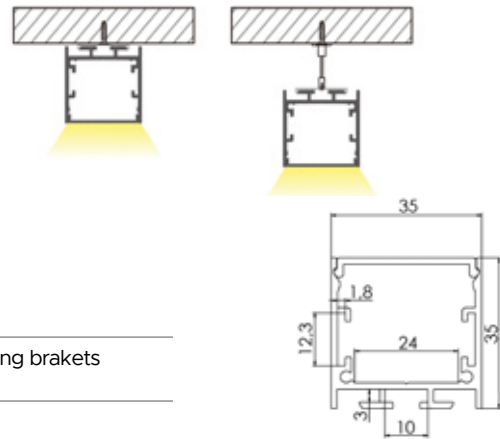

DESCRIPTION: Surface aluminium profile for LED strip system
Light distribution type: direct
Optical system: opal PC diffuser
Housing: aluminium
Colour: silver

INSTALLATION: Surface-mounted or suspended (end caps and mounting brackets included)

ENVIRONMENT: Indoor

PRODUCT	LENGTH, mm	WIDTH, mm	HEIGHT, mm	COLOUR
Alu profile set S35350 SILVER 2m	2000	35,0	35,0	Silver
Alu profile set S35350 SILVER 3m	3000	35,0	35,0	Silver

AVAILABLE ACCESSORIES:



Product: End CAP - S35350 S
Description: Silver end cap



Product: END CAP with hole - S35350 S
Description: Silver end cap with hole



Product: JOINT I - S3535M M
Description: I joint accessory



Product: MNT BRACKET - S35350 M
Description: Metallic mounting bracket



Product: SUS WIRE - S35350 M
Description: Suspension wire



ALU PROFILE SET R2720

LED Strips and Profiles

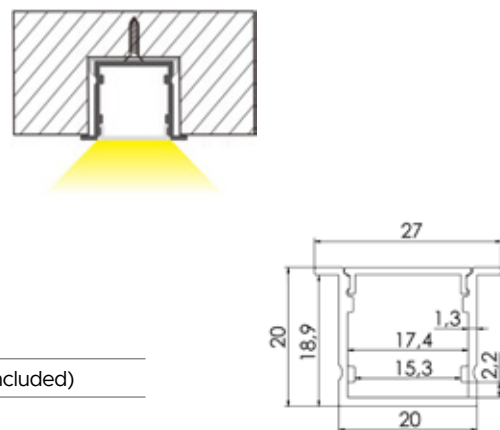

DESCRIPTION: Recessed aluminium profile for LED strip system
Light distribution type: direct
Optical system: opal PC diffuser
Housing: aluminium
Colour: silver

INSTALLATION: Recessed-mounted (end caps and mounting brackets included)

ENVIRONMENT: Indoor

PRODUCT	LENGTH, mm	WIDTH, mm	HEIGHT, mm	COLOUR
Alu profile set R2720 SILVER 2m	2000	27,0	20,0	Silver
Alu profile set R2720 SILVER 3m	3000	27,0	20,0	Silver

AVAILABLE ACCESSORIES:



Product: End CAP - R2720 S
Description: Silver end cap



Product: END CAP with hole - R2720 S
Description: Silver end cap with hole



Product: MNT BRACKET - R2720 M
Description: Metallic mounting bracket

ALU PROFILE SET R3525

LED Strips and Profiles

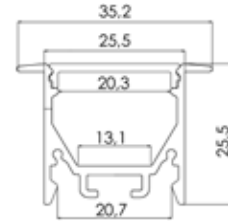
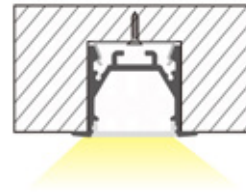

DESCRIPTION: Recessed aluminium profile for LED strip system
Light distribution type: direct
Optical system: opal PC diffuser
Housing: aluminium
Colour: silver

INSTALLATION: Recessed-mounted (end caps and mounting clips included)

ENVIRONMENT: Indoor

PRODUCT	LENGTH, mm	WIDTH, mm	HEIGHT, mm	COLOUR
Alu profile set R3525 SILVER 2m	2000	35,2	25,5	Silver
Alu profile set R3525 SILVER 3m	3000	35,2	25,5	Silver

AVAILABLE ACCESSORIES:



Product: End CAP - R3525 S
Description: Silver end cap

Product: END CAP with hole - R3525 S
Description: Silver end cap with hole



Product: JOINT I - R3525 M
Description: I joint accessory



Product: MNT BRACKET - R3525 M
Description: Metallic mounting bracket

Product: MNT CLIP - R3525 M
Description: Metallic mounting clip

ALU PROFILE SET R5035

LED Strips and Profiles

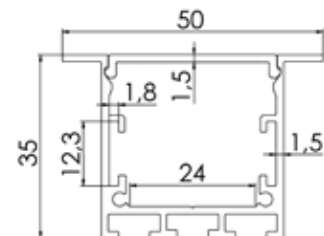
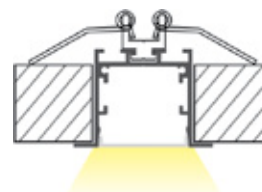
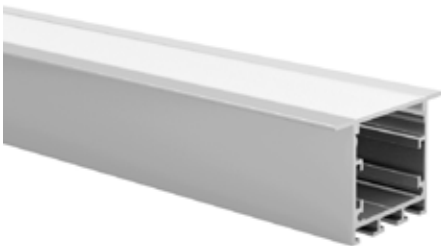





DESCRIPTION: Recessed aluminium profile for LED strip system
Light distribution type: direct
Optical system: opal PC diffuser
Housing: aluminium
Colour: silver





INSTALLATION: Recessed-mounted (end caps and mounting clips included)

ENVIRONMENT: Indoor

PRODUCT	LENGTH, mm	WIDTH, mm	HEIGHT, mm	COLOUR
Alu profile set R5035 SILVER 2m	2000	50,0	35,0	Silver
Alu profile set R5035 SILVER 3m	3000	50,0	35,0	Silver

AVAILABLE ACCESSORIES:

-  **Product:** End CAP - R5035 S
Description: Silver end cap
-  **Product:** END CAP with hole - R5035 S
Description: Silver end cap with hole
-  **Product:** End CAP - R5035 B
Description: Black end cap
-  **Product:** END CAP with hole - R5035 B
Description: Black end cap with hole
-  **Product:** JOINT I - S2525 M
Description: I joint accessory

-  **Product:** MNT BRACKET - R5035 M
Description: Metalic mounting bracket
-  **Product:** MNT CLIP - R5035 M
Description: Metalic mounting clip
-  **Product:** SUS WIRE - R5035 M
Description: Suspension wire
-  **Product:** JOINT L - S2525 M
Description: L joint accessory

ALU PROFILE SET O1713

LED Strips and Profiles

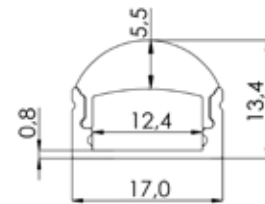
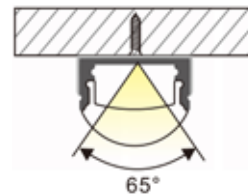





DESCRIPTION: **Optical aluminium profile for LED strip system**
Light distribution type: direct
Optical system: translucent lens, 65°
Housing: aluminium
Colour: silver; black

INSTALLATION: Surface-mounted (end caps and mounting brakets included)

ENVIRONMENT: Indoor

PRODUCT	LENGTH, mm	WIDTH, mm	HEIGHT, mm	COLOUR
Alu profile set O1713 SILVER 2m	2000	17,0	13,4	Silver
Alu profile set O1713 SILVER 3m	3000	17,0	13,4	Silver
Alu profile set O1713 BLACK 2m	2000	17,0	13,4	Black
Alu profile set O1713 BLACK 3m	3000	17,0	13,4	Black

AVAILABLE ACCESSORIES:

-  **Product:** End CAP - O1713 S
Description: Silver end cap
-  **Product:** END CAP with hole - O1713 S
Description: Silver end cap with hole
-  **Product:** End CAP - O1713 B
Description: Black end cap
-  **Product:** END CAP with hole - O1713 B
Description: Black end cap with hole

-  **Product:** MNT BRACKET - O1713 M
Description: Metalic mounting bracket

ALU PROFILE SET O2413

LED Strips and Profiles

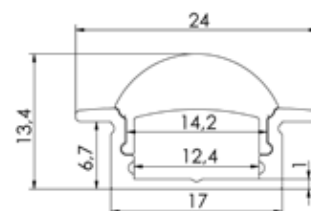
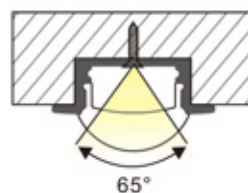
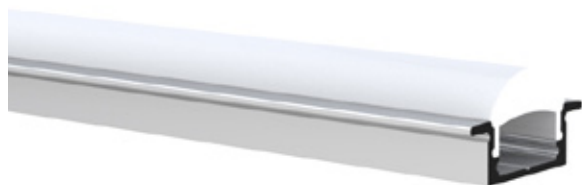

DESCRIPTION: **Optical aluminium profile for LED strip system**
Light distribution type: direct
Optical system: translucent lens, 65°
Housing: aluminium
Colour: silver; black

INSTALLATION: Recessed-mounted (end caps and mounting brackets included)

ENVIRONMENT: Indoor

PRODUCT	LENGTH, mm	WIDTH, mm	HEIGHT, mm	COLOUR
Alu profile set O2413 SILVER 2m	2000	24,0	13,4	Silver
Alu profile set O2413 SILVER 3m	3000	24,0	13,4	Silver
Alu profile set O2413 BLACK 2m	2000	24,0	13,4	Black
Alu profile set O2413 BLACK 3m	3000	24,0	13,4	Black

AVAILABLE ACCESSORIES:



Product: End CAP - O2413 S
Description: Silver end cap
Product: END CAP with hole - O2413 S
Description: Silver end cap with hole
Product: End CAP - O2413 B
Description: Black end cap
Product: END CAP with hole - O2413 B
Description: Black end cap with hole



Product: MNT BRACKET - O2413 M
Description: Metallic mounting bracket

ALU PROFILE SET C1616

LED Strips and Profiles

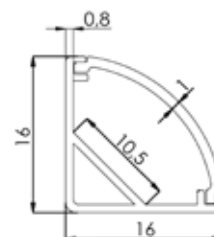
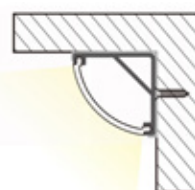

DESCRIPTION: **Corner aluminium profile for LED strip system**
Light distribution type: direct
Optical system: opal PC diffuser
Housing: aluminium
Colour: silver; black

INSTALLATION: In the corner (end caps and mounting brackets included)

ENVIRONMENT: Indoor

PRODUCT	LENGTH, mm	WIDTH, mm	HEIGHT, mm	COLOUR
Alu profile set C1616 SILVER 2m	2000	16,0	16,0	Silver
Alu profile set C1616 SILVER 3m	3000	16,0	16,0	Silver
Alu profile set C1616 BLACK 2m	2000	16,0	16,0	Black
Alu profile set C1616 BLACK 3m	3000	16,0	16,0	Black

AVAILABLE ACCESSORIES:



Product: End CAP - C1616 S
Description: Silver end cap
Product: END CAP with hole - C1616 S
Description: Silver end cap with hole

Product: End CAP - C1616 B
Description: Black end cap
Product: END CAP with hole - C1616 B
Description: Black end cap with hole

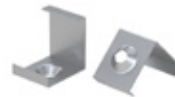

Product: MNT BRACKET - C1616 M
Description: Metallic mounting bracket

ALU PROFILE SET C1818

LED Strips and Profiles

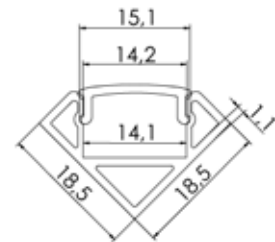
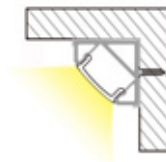

DESCRIPTION: **Corner aluminium profile for LED strip system**
Light distribution type: direct
Optical system: opal PC diffuser
Housing: aluminium
Colour: silver

INSTALLATION: In the corner (end caps and mounting brackets included)

ENVIRONMENT: Indoor

PRODUCT	LENGTH, mm	WIDTH, mm	HEIGHT, mm	COLOUR
Alu profile set C1818 SILVER 2m	2000	18,5	18,5	Silver
Alu profile set C1818 SILVER 3m	3000	18,5	18,5	Silver

AVAILABLE ACCESSORIES:



Product: End CAP - C1818 S
Description: Silver end cap
Product: END CAP with hole - C1818 S
Description: Silver end cap with hole



Product: MNT BRACKET - C1818 M
Description: Metallic mounting bracket

ALU PROFILE SET C3030

LED Strips and Profiles

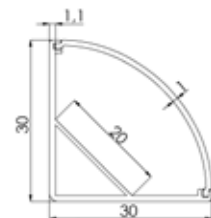
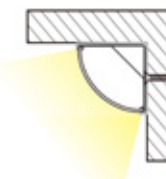

DESCRIPTION: **Corner aluminium profile for LED strip system**
Light distribution type: direct
Optical system: opal PC diffuser
Housing: aluminium
Colour: silver

INSTALLATION: In the corner (end caps and mounting brackets included)

ENVIRONMENT: Indoor

PRODUCT	LENGTH, mm	WIDTH, mm	HEIGHT, mm	COLOUR
Alu profile set C3030 SILVER 2m	2000	30,0	30,0	Silver
Alu profile set C3030 SILVER 3m	3000	30,0	30,0	Silver

AVAILABLE ACCESSORIES:



Product: End CAP - C3030 S
Description: Silver end cap
Product: END CAP with hole - C3030 S
Description: Silver end cap with hole



Product: MNT BRACKET - C3030 M
Description: Metallic mounting bracket

ALU PROFILE SET C2016



LED Strips and Profiles

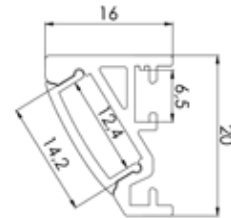
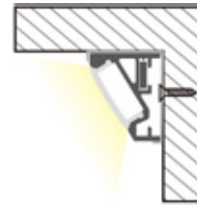

DESCRIPTION: **Corner aluminium profile for LED strip system**
Light distribution type: direct
Optical system: opal PC diffuser
Housing: aluminium
Colour: silver

INSTALLATION: In the corner (end caps and mounting brackets included)

ENVIRONMENT: Indoor

PRODUCT	LENGTH, mm	WIDTH, mm	HEIGHT, mm	COLOUR
Alu profile set C2016 SILVER 2m	2000	20,0	16,0	Silver
Alu profile set C2016 SILVER 3m	3000	20,0	16,0	Silver

AVAILABLE ACCESSORIES:



Product: End CAP - C2016 S
Description: Silver end cap

Product: END CAP with hole - C2016 S
Description: Silver end cap with hole



Product: MNT BRACKET - C2016 M
Description: Metallic mounting bracket

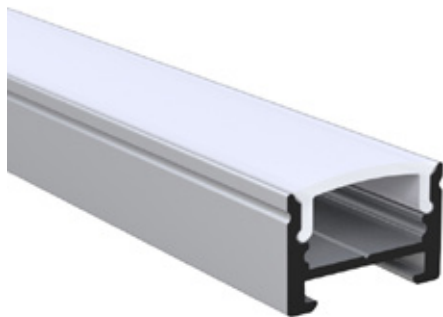

ALU PROFILE SET M1711

LED Strips and Profiles

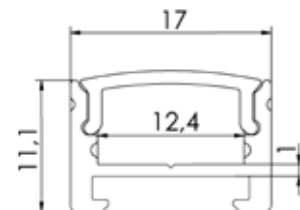
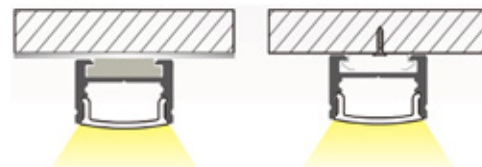

DESCRIPTION: **Magnetic aluminium profile for LED strip system**
Light distribution type: direct
Optical system: opal PC diffuser
Housing: aluminium
Colour: silver

INSTALLATION: On the horizontal or vertical metal surface (end caps and magnets included)

ENVIRONMENT: Indoor

PRODUCT	LENGTH, mm	WIDTH, mm	HEIGHT, mm	COLOUR
Alu profile set M1711 SILVER 2m	2000	17,0	11,1	Silver
Alu profile set M1711 SILVER 3m	3000	17,0	11,1	Silver

AVAILABLE ACCESSORIES:



Product: End CAP - M1711 S
Description: Silver end cap

Product: END CAP with hole - M1711 S
Description: Silver end cap with hole



Product: MNT BRACKET - M1711 M
Description: Metallic mounting bracket

Product: MAGNET- M1711 M
Description: Magnet

ALU PROFILE SET B1705

LED Strips and Profiles

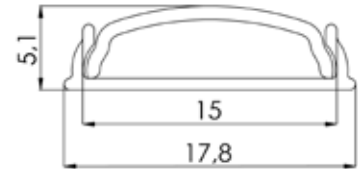
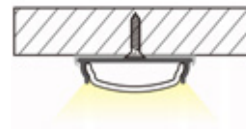

DESCRIPTION: Bendable aluminium profile for LED strip system
Light distribution type: direct
Optical system: opal PC diffuser
Housing: aluminium
Colour: silver; black

INSTALLATION: On the horizontal or vertical surface (end caps and mounting brackets included)

ENVIRONMENT: Indoor

PRODUCT	LENGTH, mm	WIDTH, mm	HEIGHT, mm	COLOUR
Alu profile set B1705 SILVER 2m	2000	17,8	5,1	Silver
Alu profile set B1705 SILVER 3m	3000	17,8	5,1	Silver
Alu profile set B1705 BLACK 2m	2000	17,8	5,1	Black
Alu profile set B1705 BLACK 3m	3000	17,8	5,1	Black

AVAILABLE ACCESSORIES:



Product: End CAP - B1705 S
Description: Silver end cap
Product: END CAP with hole - B1705 S
Description: Silver end cap with hole



Product: MNT BRACKET - B1705 M
Description: Metallic mounting bracket

Product: End CAP - B1705 B
Description: Black end cap
Product: END CAP with hole - B1705 B
Description: Black end cap with hole

ALU PROFILE SET W1580

LED Strips and Profiles

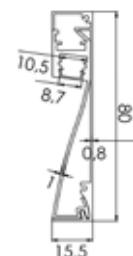

DESCRIPTION: Wall-mounted aluminium profile for LED strip system
Light distribution type: direct
Optical system: opal PC diffuser
Housing: aluminium
Colour: black

INSTALLATION: On the wall (end caps included)

ENVIRONMENT: Indoor

PRODUCT	LENGTH, mm	WIDTH, mm	HEIGHT, mm	COLOUR
Alu profile set W1580 BLACK 2m	2000	15,5	80,0	Black
Alu profile set W1580 BLACK 3m	3000	15,5	80,0	Black

AVAILABLE ACCESSORIES:



Product: End CAP - W1580 S
Description: Silver end cap
Product: END CAP with hole - W1580 S
Description: Silver end cap with hole

Product: End CAP - W1580 B
Description: Black end cap
Product: END CAP with hole - W1580 B
Description: Black end cap with hole

ALU PROFILE SET W20100

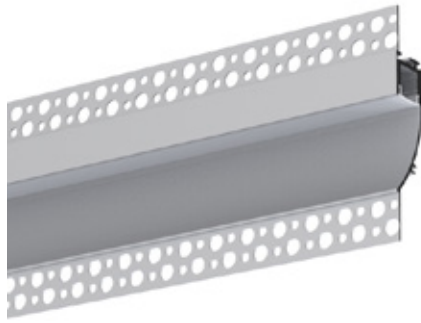

LED Strips and Profiles



DESCRIPTION: Recessed wall-mounted aluminium profile for LED strip system
Light distribution type: indirect
Optical system: opal PC diffuser
Housing: aluminium
Colour: silver

INSTALLATION: In the wall (end caps included)

ENVIRONMENT: Indoor

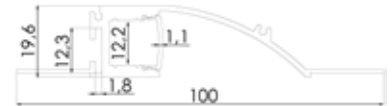

PRODUCT	LENGTH, mm	WIDTH, mm	HEIGHT, mm	COLOUR
Alu profile set W20100 SILVER 2m	2000	19,6	100,0	Silver
Alu profile set W20100 SILVER 3m	3000	19,6	100,0	Silver

AVAILABLE ACCESSORIES:



Product: End CAP - W20100 S
Description: Silver end cap

Product: END CAP with hole - W20100 S
Description: Silver end cap with hole

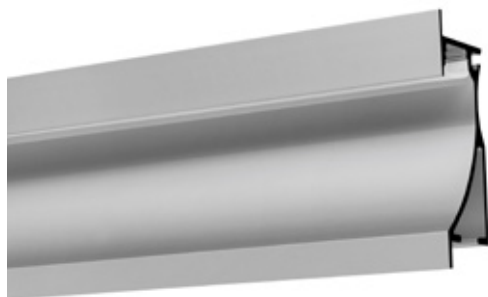

ALU PROFILE SET W2778

LED Strips and Profiles



DESCRIPTION: Recessed wall-mounted aluminium profile for LED strip system
Light distribution type: indirect
Optical system: opal PC diffuser
Housing: aluminium
Colour: silver

INSTALLATION: In the wall (end caps included)

ENVIRONMENT: Indoor

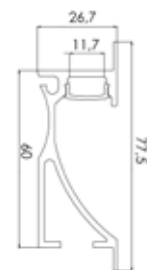

PRODUCT	LENGTH, mm	WIDTH, mm	HEIGHT, mm	COLOUR
Alu profile set W2778 SILVER 2m	2000	26,7	77,5	Silver
Alu profile set W2778 SILVER 3m	3000	26,7	77,5	Silver

AVAILABLE ACCESSORIES:



Product: End CAP - W2778 S
Description: Silver end cap

Product: END CAP with hole - W2778 S
Description: Silver end cap with hole

ALU PROFILE SET W3749

LED Strips and Profiles

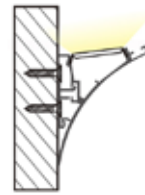

DESCRIPTION: **Wall-mounted aluminium profile for LED strip system**
Light distribution type: direct
Optical system: opal PC diffuser
Housing: aluminium
Colour: white

INSTALLATION: On the wall (end caps included)

ENVIRONMENT: Indoor

PRODUCT	LENGTH, mm	WIDTH, mm	HEIGHT, mm	COLOUR
Alu profile set W3749 WHITE 2m	2000	37,1	49,1	White
Alu profile set W3749 WHITE 3m	3000	37,1	49,1	White

AVAILABLE ACCESSORIES:



Product: End CAP - W3749 W
Description: White end cap

Product: END CAP with hole - W3749 W
Description: White end cap with hole



ALU PROFILE SET W4390

LED Strips and Profiles

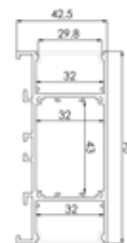

DESCRIPTION: **Wall-mounted aluminium profile for LED strip system**
Light distribution type: direct/indirect
Optical system: opal PC diffuser
Housing: aluminium
Colour: silver

INSTALLATION: On the wall (end caps and mounting brackets included)

ENVIRONMENT: Indoor

PRODUCT	LENGTH, mm	WIDTH, mm	HEIGHT, mm	COLOUR
Alu profile set W4390 SILVER 2m	2000	42,5	90,0	Silver
Alu profile set W4390 SILVER 3m	3000	42,5	90,0	Silver

AVAILABLE ACCESSORIES:



Product: End CAP - W4390 S
Description: Silver end cap
Product: END CAP with hole - W4390 S
Description: Silver end cap with hole



Product: MNT BRACKET - W4390 M
Description: Metallic mounting bracket

ALU PROFILE SET T5715

LED Strips and Profiles

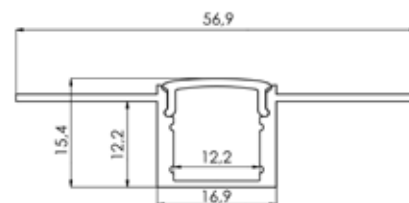
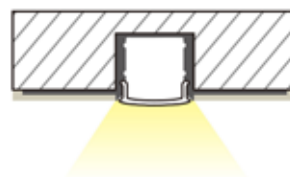

DESCRIPTION: Trimless aluminium profile for LED strip system
Light distribution type: direct
Optical system: opal PC diffuser
Housing: aluminium
Colour: silver

INSTALLATION: Recessed-mounted (end caps included)

ENVIRONMENT: Indoor

PRODUCT	LENGTH, mm	WIDTH, mm	HEIGHT, mm	COLOUR
Alu profile set T5715 SILVER 2m	2000	56,9	15,4	Silver
Alu profile set T5715 SILVER 3m	3000	56,9	15,4	Silver

AVAILABLE ACCESSORIES:



Product: End CAP - T5715 S
Description: Silver end cap
Product: END CAP with hole - T5715 S
Description: Silver end cap with hole

ALU PROFILE SET T6214

LED Strips and Profiles

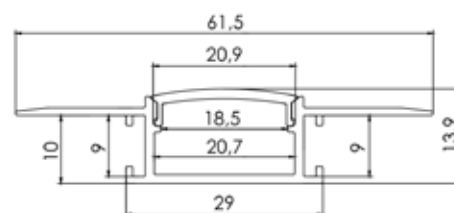
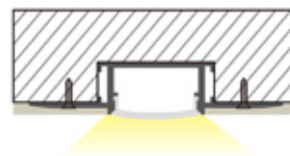

DESCRIPTION: Trimless aluminium profile for LED strip system
Light distribution type: direct
Optical system: opal PC diffuser
Housing: aluminium
Colour: silver

INSTALLATION: In the ceiling (end caps included)

ENVIRONMENT: Indoor

PRODUCT	LENGTH, mm	WIDTH, mm	HEIGHT, mm	COLOUR
Alu profile set T6214 SILVER 2m	2000	61,5	13,9	Silver
Alu profile set T6214 SILVER 3m	3000	61,5	13,9	Silver

AVAILABLE ACCESSORIES:



Product: End CAP - T6214 S
Description: Silver end cap
Product: END CAP with hole - T6214 S
Description: Silver end cap with hole



Product: JOINT I - T6214 M
Description: I joint accessory

ALU PROFILE SET T7319

LED Strips and Profiles

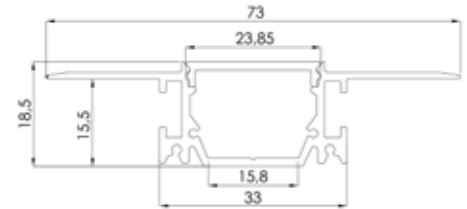
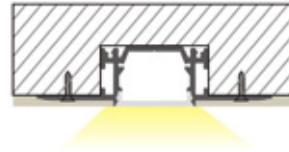

DESCRIPTION: Trimless aluminium profile for LED strip system
Light distribution type: direct
Optical system: opal PC diffuser
Housing: aluminium
Colour: silver

INSTALLATION: In the ceiling (end caps included)

ENVIRONMENT: Indoor

PRODUCT	LENGTH, mm	WIDTH, mm	HEIGHT, mm	COLOUR
Alu profile set T7319 SILVER 2m	2000	73,0	18,5	Silver
Alu profile set T7319 SILVER 3m	3000	73,0	18,5	Silver

AVAILABLE ACCESSORIES:

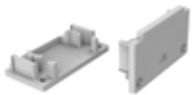

Product: End CAP - T7319 S
Description: Silver end cap

Product: END CAP with hole - T7319 S
Description: Silver end cap with hole



Product: JOINT I - T7319 M
Description: I joint accessory

ALU PROFILE SET T8819

LED Strips and Profiles

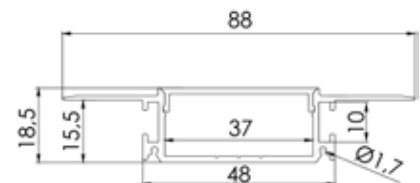
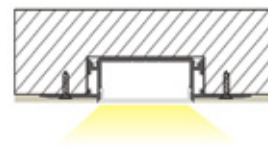

DESCRIPTION: Trimless aluminium profile for LED strip system
Light distribution type: direct
Optical system: opal PC diffuser
Housing: aluminium
Colour: silver

INSTALLATION: In the ceiling (end caps included)

ENVIRONMENT: Indoor

PRODUCT	LENGTH, mm	WIDTH, mm	HEIGHT, mm	COLOUR
Alu profile set T8819 SILVER 2m	2000	88,0	18,5	Silver
Alu profile set T8819 SILVER 3m	3000	88,0	18,5	Silver

AVAILABLE ACCESSORIES:



Product: End CAP - T8819 S
Description: Silver end cap

Product: END CAP with hole - T8819 S
Description: Silver end cap with hole



Product: JOINT I - T8819 M
Description: I joint accessory

ALU PROFILE SET F2011

LED Strips and Profiles

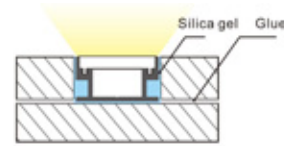

DESCRIPTION: Floor-mounted aluminium profile for LED strip system
Light distribution type: direct
Optical system: opal PC diffuser
Housing: aluminium
Colour: silver

INSTALLATION: In the floor (end caps included)

ENVIRONMENT: Indoor

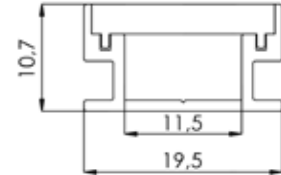

PRODUCT	LENGTH, mm	WIDTH, mm	HEIGHT, mm	COLOUR
Alu profile set F2011 SILVER 2m	2000	19,5	10,7	Silver
Alu profile set F2011 SILVER 3m	3000	19,5	10,7	Silver

AVAILABLE ACCESSORIES:



Product: End CAP - F2011 S

Description: Silver end cap

Product: END CAP with hole - F2011 S

Description: Silver end cap with hole

ALU PROFILE SET F2126

LED Strips and Profiles

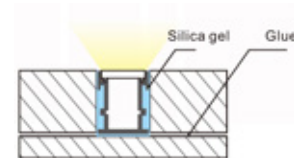
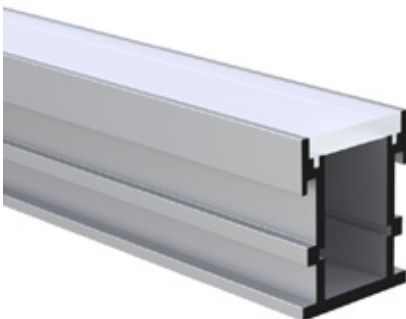

DESCRIPTION: Floor-mounted aluminium profile for LED strip system
Light distribution type: direct
Optical system: opal PC diffuser
Housing: aluminium
Colour: silver

INSTALLATION: In the floor (end caps included)

ENVIRONMENT: Indoor

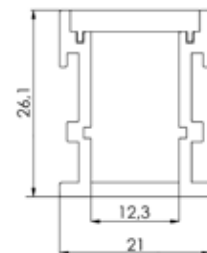

PRODUCT	LENGTH, mm	WIDTH, mm	HEIGHT, mm	COLOUR
Alu profile set F2126 SILVER 2m	2000	21,0	26,1	Silver
Alu profile set F2126 SILVER 3m	3000	21,0	26,1	Silver

AVAILABLE ACCESSORIES:



Product: End CAP - F2126 S

Description: Silver end cap

Product: END CAP with hole - F2126 S

Description: Silver end cap with hole

ALU PROFILE SET F2711

LED Strips and Profiles

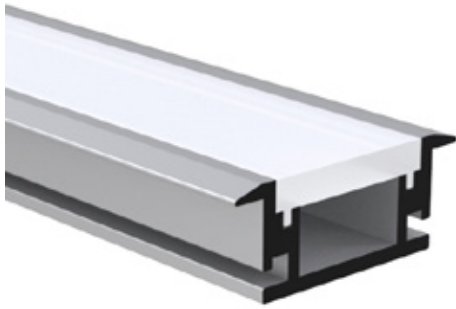
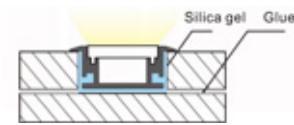

DESCRIPTION: Floor-mounted aluminium profile for LED strip system
Light distribution type: direct
Optical system: opal PC diffuser
Housing: aluminium
Colour: silver

INSTALLATION: In the floor (end caps included)

ENVIRONMENT: Indoor

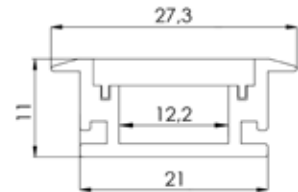

PRODUCT	LENGTH, mm	WIDTH, mm	HEIGHT, mm	COLOUR
Alu profile set F2711 SILVER 2m	2000	27,3	11,0	Silver
Alu profile set F2711 SILVER 3m	3000	27,3	11,0	Silver

AVAILABLE ACCESSORIES:



Product: End CAP - F2711 S
Description: Silver end cap

Product: END CAP with hole - F2711 S
Description: Silver end cap with hole

ALU PROFILE SET F6528

LED Strips and Profiles

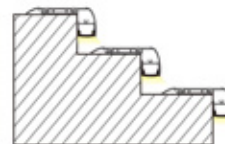

DESCRIPTION: Stair-step aluminium profile for LED strip system
Light distribution type: direct
Optical system: opal PC diffuser
Housing: aluminium
Colour: black

INSTALLATION: On the stair-step (end caps included)

ENVIRONMENT: Indoor

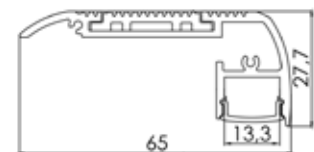

PRODUCT	LENGTH, mm	WIDTH, mm	HEIGHT, mm	COLOUR
Alu profile set F6528 BLACK 2m	2000	65,0	27,7	Black
Alu profile set F6528 BLACK 3m	3000	65,0	27,7	Black

AVAILABLE ACCESSORIES:



Product: End CAP - F6528 B
Description: Black end cap

Product: END CAP with hole - F6528 B
Description: Black end cap with hole

ALU PROFILE SET I1809

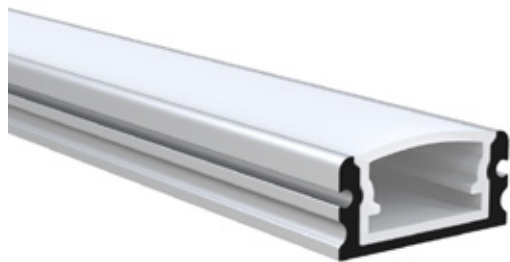

LED Strips and Profiles

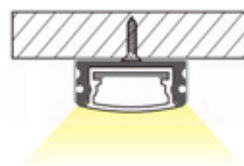

DESCRIPTION: Waterproof aluminium profile for LED strip system
Light distribution type: direct
Optical system: opal PC diffuser
Housing: aluminium
Colour: silver

INSTALLATION: On the ceiling or wall (end caps and mounting brackets included)

ENVIRONMENT: Outdoor with roof

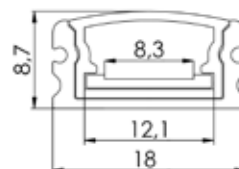

PRODUCT	LENGTH, mm	WIDTH, mm	HEIGHT, mm	COLOUR
Alu profile set I1809 SILVER 2m	2000	18,0	8,7	Silver
Alu profile set I1809 SILVER 3m	3000	18,0	8,7	Silver

AVAILABLE ACCESSORIES:



Product: End CAP - I1809 S

Description: Silver end cap

Product: END CAP with hole - I1809 S

Description: Silver end cap with hole



Product: End CAP - I1809 silicone

Description: Silicone end cap

Product: END CAP with hole - I1809 silicone

Description: Silicone end cap with hole



Product: MNT BRACKET - I1809 M

Description: Metallic mounting bracket

ALU PROFILE SET I2609

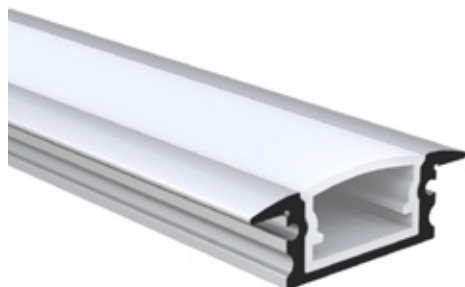

LED Strips and Profiles

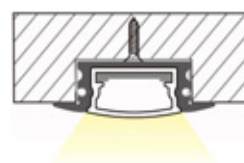

DESCRIPTION: Waterproof aluminium profile for LED strip system
Light distribution type: direct
Optical system: opal PC diffuser
Housing: aluminium
Colour: silver

INSTALLATION: In the ceiling or wall (end caps and mounting brackets included)

ENVIRONMENT: Outdoor with roof

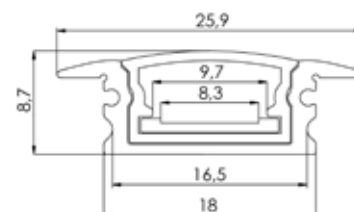

PRODUCT	LENGTH, mm	WIDTH, mm	HEIGHT, mm	COLOUR
Alu profile set I2609 SILVER 2m	2000	25,9	8,7	Silver
Alu profile set I2609 SILVER 3m	3000	25,9	8,7	Silver

AVAILABLE ACCESSORIES:



Product: End CAP - I2609 S

Description: Silver end cap

Product: END CAP with hole - I2609 S

Description: Silver end cap with hole



Product: End CAP - I2609 silicone

Description: Silicone end cap

Product: END CAP with hole - I2609 silicone

Description: Silicone end cap with hole



Product: MNT BRACKET - I2609 M

Description: Metallic mounting bracket

ALU PROFILE SET I1813

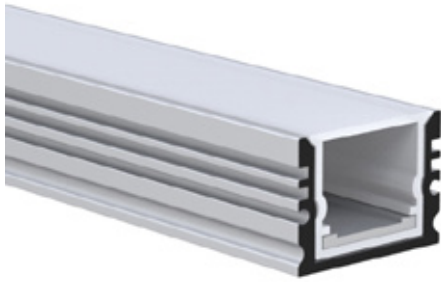

LED Strips and Profiles

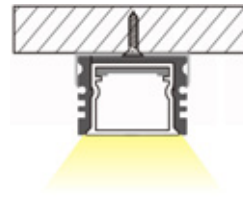

DESCRIPTION: Waterproof aluminium profile for LED strip system
Light distribution type: direct
Optical system: opal PC diffuser
Housing: aluminium
Colour: silver

INSTALLATION: On the ceiling or wall (end caps and mounting brackets included)

ENVIRONMENT: Outdoor with roof

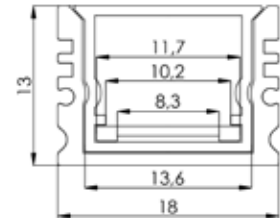

PRODUCT	LENGTH, mm	WIDTH, mm	HEIGHT, mm	COLOUR
Alu profile set I1813 SILVER 2m	2000	18,0	13,0	Silver
Alu profile set I1813 SILVER 3m	3000	18,0	13,0	Silver

AVAILABLE ACCESSORIES:



Product: End CAP - I1813 S
Description: Silver end cap
Product: END CAP with hole - I1813 S
Description: Silver end cap with hole



Product: End CAP - I1813 silicone
Description: Silicone end cap
Product: END CAP with hole - I1813 silicone
Description: Silicone end cap with hole



Product: MNT BRACKET - I1813 M
Description: Metallic mounting bracket

ALU PROFILE SET I2613

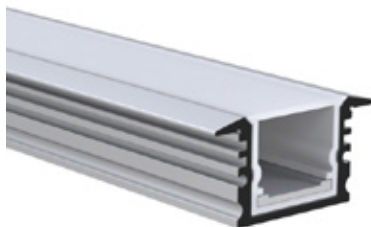

LED Strips and Profiles

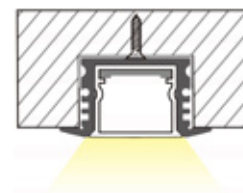

DESCRIPTION: Waterproof aluminium profile for LED strip system
Light distribution type: direct
Optical system: opal PC diffuser
Housing: aluminium
Colour: silver

INSTALLATION: In the ceiling or wall (end caps and mounting brackets included)

ENVIRONMENT: Outdoor with roof

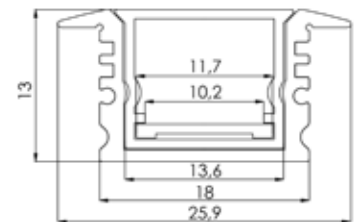

PRODUCT	LENGTH, mm	WIDTH, mm	HEIGHT, mm	COLOUR
Alu profile set I2613 SILVER 2m	2000	25,9	13,0	Silver
Alu profile set I2613 SILVER 3m	3000	25,9	13,0	Silver

AVAILABLE ACCESSORIES:



Product: End CAP - I2613 S
Description: Silver end cap
Product: END CAP with hole - I2613 S
Description: Silver end cap with hole



Product: End CAP - I2613 silicone
Description: Silicone end cap
Product: END CAP with hole - I2613 silicone
Description: Silicone end cap with hole



Product: MNT BRACKET - I2613 M
Description: Metallic mounting bracket



ALU PROFILE SET I1616

LED Strips and Profiles

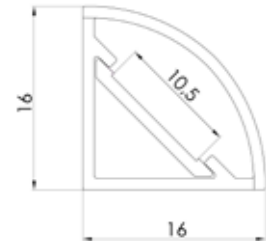
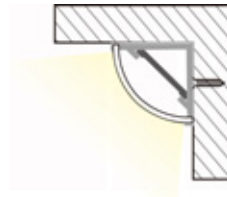

DESCRIPTION: **Waterproof aluminium profile for LED strip system**
Light distribution type: direct
Optical system: opal PC diffuser
Housing: opal PC diffuser
Colour: opal

INSTALLATION: In the corner (end caps and mounting brackets included)

ENVIRONMENT: Outdoor with roof

PRODUCT	LENGTH, mm	WIDTH, mm	HEIGHT, mm	COLOUR
Alu profile set I1616 OP 2m	2000	16,0	16,0	Opal
Alu profile set I1616 OP 3m	3000	16,0	16,0	Opal

AVAILABLE ACCESSORIES:



Product: End CAP - I1616 silicone
Description: Silicone end cap
Product: END CAP with hole - I1616 silicone
Description: Silicone end cap with hole



Product: MNT BRACKET - I1616 M
Description: Metallic mounting bracket



ALU PROFILE SET D6060

LED Strips and Profiles

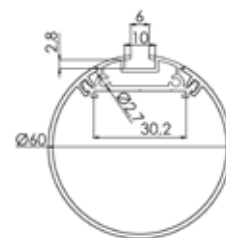
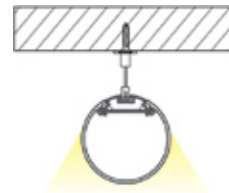

DESCRIPTION: **Decorative aluminium profile for LED strip system**
Light distribution type: omnidirectional
Optical system: opal PC diffuser
Housing: aluminium
Colour: silver

INSTALLATION: Suspended (end caps and suspension wire included)

ENVIRONMENT: Indoor

PRODUCT	LENGTH, mm	WIDTH, mm	HEIGHT, mm	COLOUR
Alu profile set D6060 SILVER 2m	2000	60,0	60,0	Silver
Alu profile set D6060 SILVER 3m	3000	60,0	60,0	Silver

AVAILABLE ACCESSORIES:



Product: End CAP - D6060 S
Description: Silver end cap
Product: END CAP with hole - D6060 S
Description: Silver end cap with hole



Product: SUS WIRE - D6060 M
Description: Silicone end cap

ALU PROFILE SET D7676

LED Strips and Profiles

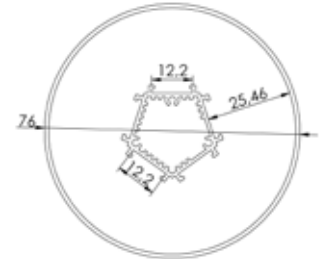

DESCRIPTION: Decorative aluminium profile for LED strip system
Light distribution type: omnidirectional
Optical system: opal PC diffuser
Housing: aluminium
Colour: silver

INSTALLATION: Suspended (end caps and suspension wire included)

ENVIRONMENT: Indoor

PRODUCT	LENGTH, mm	WIDTH, mm	HEIGHT, mm	COLOUR
Alu profile set D7676 SILVER 2m	2000	76,0	76,0	Silver
Alu profile set D7676 SILVER 3m	3000	76,0	76,0	Silver

AVAILABLE ACCESSORIES:



Product: End CAP - D7676 S
Description: Silver end cap



Product: SUS WIRE - D7676 M
Description: Suspension wire

ALU PROFILE SET D3030

LED Strips and Profiles

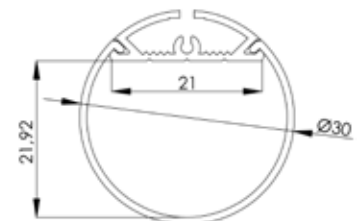

DESCRIPTION: Decorative aluminium profile for LED strip system
Light distribution type: omnidirectional
Optical system: opal PC diffuser
Housing: aluminium
Colour: silver

INSTALLATION: Suspended (end caps and suspension wire included)

ENVIRONMENT: Indoor

PRODUCT	LENGTH, mm	WIDTH, mm	HEIGHT, mm	COLOUR
Alu profile set D3030 SILVER 2m	2000	30,0	30,0	Silver
Alu profile set D3030 SILVER 3m	3000	30,0	30,0	Silver

AVAILABLE ACCESSORIES:



Product: End CAP - D3030 S
Description: Silver end cap

Product: END CAP with hole - D3030 S
Description: Silver end cap with hole



Product: SUS WIRE - D3030 S
Description: Suspension wire

LED STRIPS

LED Strips and Profiles



DESCRIPTION: **LED strip with double-sided tape**
Light distribution type: direct
Optical system: SAMSUNG 2835 LEDs
Housing: PCB
Colour: white

GENERAL DATA: **Mains voltage:** 24V
LED lifetime, h: 50000/L80B50
SDMC: 3
Protection class IEC: III
Ingress protection code: IP20
Mechanical impact resistance: IK02
Operating temperature range, °C: ta -20...+45

INSTALLATION: In the aluminium profile. Cable, 0.15m, 2x1mm²

ENVIRONMENT: Indoor

PRODUCT	LENGTH, mm	WIDTH, mm	HEIGHT, mm	LUMINAIRE OUTPUT*, lm	SYSTEM POWER*, W	SYSTEM EFFICACY*, lm/W	CRI	CCT*, K
Strip LED1x650 3.8W/140 S001 T830 DC24-5.0m	5000	8	1,2	2870	19,2	149	80+	3000
Strip LED1x1250 7.7W/140 S002 T830 DC24-5.0m	5000	8	1,2	5880	38,4	153	80+	3000
Strip LED1x1900 11.5W/140 S003 T830 DC24-5.0m	5000	8	1,2	8680	57,6	151	80+	3000
Strip LED1x2400 15.4W/140 S004 T830 DC24-5.0m	5000	8	1,2	11270	76,8	147	80+	3000
Strip LED1x2900 19.2W/140 S005 T830 DC24-5.0m	5000	8	1,2	13650	96,0	142	80+	3000
Strip LED1x650 3.8W/140 S001 T840 DC24-5.0m	5000	8	1,2	3010	19,2	157	80+	4000
Strip LED1x1250 7.7W/140 S002 T840 DC24-5.0m	5000	8	1,2	6230	38,4	162	80+	4000
Strip LED1x1900 11.5W/140 S003 T840 DC24-5.0m	5000	8	1,2	9170	57,6	159	80+	4000
Strip LED1x2400 15.4W/140 S004 T840 DC24-5.0m	5000	8	1,2	11900	76,8	155	80+	4000
Strip LED1x2900 19.2W/140 S005 T840 DC24-5.0m	5000	8	1,2	14420	96,0	150	80+	4000
Strip LED1x650 3.8W/140 S001 T930 DC24-5.0m	5000	8	1,2	2450	19,2	128	90+	3000
Strip LED1x1250 7.7W/140 S002 T930 DC24-5.0m	5000	8	1,2	4970	38,4	129	90+	3000
Strip LED1x1900 11.5W/140 S003 T930 DC24-5.0m	5000	8	1,2	7350	57,6	128	90+	3000
Strip LED1x2400 15.4W/140 S004 T930 DC24-5.0m	5000	8	1,2	10570	76,8	138	90+	3000
Strip LED1x2900 19.2W/140 S005 T930 DC24-5.0m	5000	8	1,2	11550	96,0	120	90+	3000
Strip LED1x650 3.8W/140 S001 T940 DC24-5.0m	5000	8	1,2	2590	19,2	135	90+	4000
Strip LED1x1250 7.7W/140 S002 T940 DC24-5.0m	5000	8	1,2	5320	38,4	139	90+	4000
Strip LED1x1900 11.5W/140 S003 T940 DC24-5.0m	5000	8	1,2	7840	57,6	136	90+	4000
Strip LED1x2400 15.4W/140 S004 T940 DC24-5.0m	5000	8	1,2	11200	76,8	146	90+	4000
Strip LED1x2900 19.2W/140 S005 T940 DC24-5.0m	5000	8	1,2	12320	96,0	128	90+	4000

*Tolerance range for optical and electrical data: ±10%. Values apply to an ambient temperature of 25°C. NORTHCLIFFE LIGHTING is constantly developing and improving its products. The right is reserved to change any product specifications without prior notification

**Package 5 meters, can be cut every 5 cm

OPTIONS AVAILABLE ON REQUEST:

LED		PROTECTION
T830	T930	IP67
T840	T940	

Power supply IP20 CP



LED Strips and Profiles



DESCRIPTION:	Flat CV driver with covers Housing: termoplastik Colour: white
GENERAL DATA:	Mains voltage: 220-240V, 50-60Hz Protection class IEC: II Ingress protection code: IP20 Operating temperature range, °C: ta -25...+45 DALI: -20...+50 / -25...+50
INSTALLATION:	On the horizontal or vertical surfaces. Push-in terminal, 2x1.5mm ² DIM: Two Push-in terminals, 2x1.5mm ² and 2x1.5mm ² DALI: Two screw terminals, 2x1.5mm ² and 2x1.5mm ²
ENVIRONMENT:	Indoor

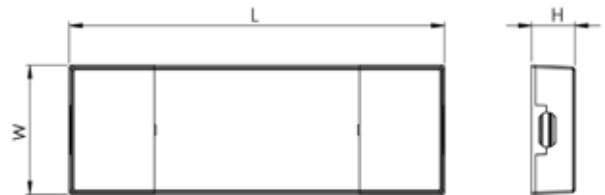

PRODUCT	LENGTH, mm	WIDTH, mm	HEIGHT, mm	SYSTEM POWER, W	WEIGHT, kg
Power supply IP20 CP 12W/24V	112,0	46,0	15,5	12,0	0,1
Power supply IP20 CP 24W/24V	137,0	50,0	15,5	24,0	0,2
Power supply IP20 CP 36W/24V	170,0	57,0	18,0	36,0	0,2
Power supply IP20 CP 60W/24V	170,0	57,0	18,0	60,0	0,2
Power supply IP20 CP 90W/24V	190,0	65,0	22,0	90,0	0,3
Power supply IP20 CP 120W/24V	190,0	65,0	22,0	120,0	0,3
Power supply IP20 CP 24W/24V DIM	137,0	50,0	15,5	24,0	0,2
Power supply IP20 CP 36W/24V DIM	170,0	57,0	18,0	36,0	0,2
Power supply IP20 CP 60W/24V DIM	170,0	57,0	18,0	60,0	0,2
Power supply IP20 CP 90W/24V DIM	190,0	65,0	22,0	90,0	0,3
Power supply IP20 CP 120W/24V DIM	190,0	65,0	22,0	120,0	0,3
Power supply IP20 CP 60W/24V DALI	170,0	57,0	18,0	60,0	0,2
Power supply IP20 CP 100W/24V DALI	190,0	65,0	22,0	100,0	0,3

Power supply IP20 LP

LED Strips and Profiles



DESCRIPTION:	Flat CV driver with covers Housing: termoplastico Colour: white
GENERAL DATA:	Mains voltage: 220-240V, 50-60Hz Protection class IEC: II Ingress protection code: IP20 Operating temperature range, °C: ta -25...+45
INSTALLATION:	On the horizontal or vertical surfaces. Screw terminal, 2x1.5mm ² DIM/DALI: Two screw terminals, 2x1.5mm ² and 2x1.5mm ²
ENVIRONMENT:	Indoor

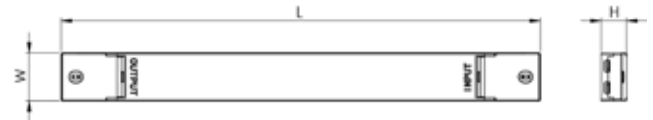

PRODUCT	LENGTH, mm	WIDTH, mm	HEIGHT, mm	SYSTEM POWER, W	WEIGHT, kg
Power supply IP20 LP 30W/24V	300,0	30,0	16,0	30,0	0,2
Power supply IP20 LP 60W/24V	300,0	30,0	16,0	60,0	0,3
Power supply IP20 LP 100W/24V	350,0	30,0	18,0	100,0	0,2
Power supply IP20 LP 150W/24V	350,0	30,0	18,0	150,0	0,3
Power supply IP20 LP 250W/24V	400,0	40,0	22,0	250,0	0,5
Power supply IP20 LP 30W/24V DIM	300,0	30,0	16,0	30,0	0,2
Power supply IP20 LP 60W/24V DIM	300,0	30,0	16,0	60,0	0,3
Power supply IP20 LP 100W/24V DIM	350,0	30,0	18,0	100,0	0,2
Power supply IP20 LP 150W/24V DIM	350,0	30,0	18,0	150,0	0,3
Power supply IP20 LP 250W/24V DIM	400,0	40,0	22,0	250,0	0,5
Power supply IP20 LP 30W/24V DALI	300,0	30,0	16,0	30,0	0,2
Power supply IP20 LP 60W/24V DALI	300,0	30,0	16,0	60,0	0,3
Power supply IP20 LP 100W/24V DALI	350,0	30,0	18,0	100,0	0,2
Power supply IP20 LP 150W/24V DALI	350,0	30,0	18,0	150,0	0,3
Power supply IP20 LP 250W/24V DALI	400,0	40,0	22,0	250,0	0,5

Power supply IP67 CP



LED Strips and Profiles



DESCRIPTION:	Flat CV driver with covers Housing: termoplastic Colour: white
GENERAL DATA:	Mains voltage: 100-250V, 50/60Hz; 150W: 100-240V, 50/60Hz Protection class IEC: II; 150W: I Ingress protection code: IP67 Operating temperature range, °C: ta -25...+50; 150W: ta -40...+50
INSTALLATION:	On the horizontal or vertical surfaces
ENVIRONMENT:	Indoor/Outdoor with roof

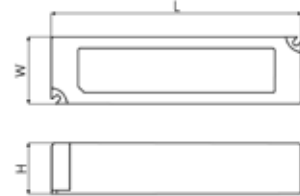

PRODUCT	LENGTH, mm	WIDTH, mm	HEIGHT, mm	SYSTEM POWER, W	WEIGHT, kg
Power supply IP67 CP 36W/24V	148,0	40,0	30,0	36,0	0,3
Power supply IP67 CP 60W/24V	166,0	42,0	34,0	60,0	0,4
Power supply IP67 CP 100W/24V	190,0	52,0	37,0	100,0	0,7



PRODUCT	LENGTH, mm	WIDTH, mm	HEIGHT, mm	SYSTEM POWER, W	WEIGHT, kg
Power supply IP67 CP 150W/24V	215,0	53,0	31,5	150,0	0,7

INFORMATION ABOUT LIGHTING

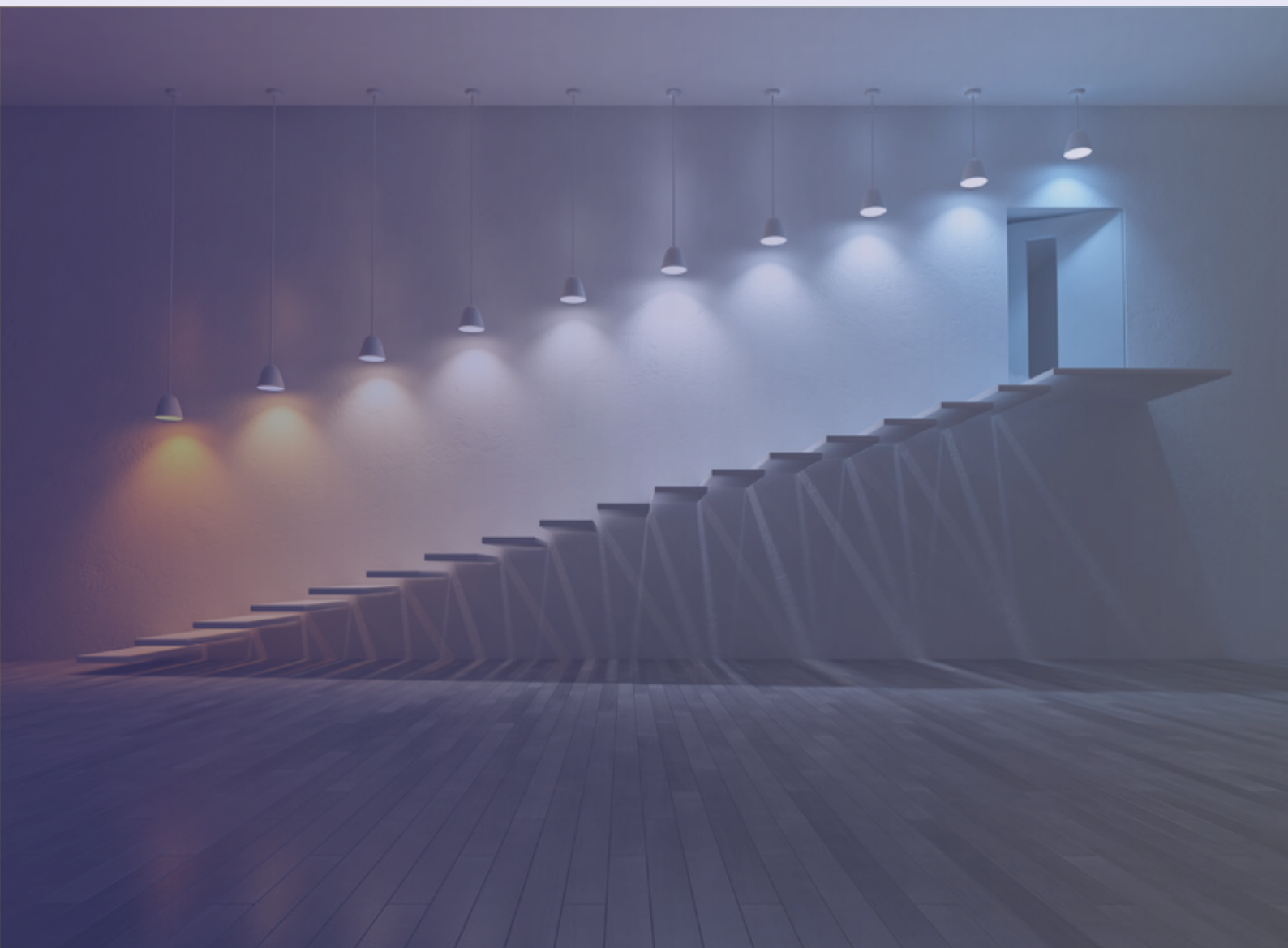

LIGHT TERMINOLOGY

LUMINOUS FLUX Φ (lm)

The luminous flux describes the quantity of light emitted by a light source per second.
The luminous efficacy is the ratio of the luminous flux to the electrical power consumed (lm/W). It is a measure of economic efficacy of a light source.

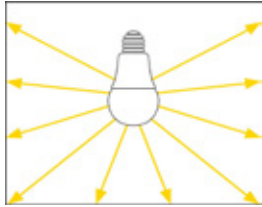

Φ - luminous flux
lm - Lumen

ILLUMINANCE L (lx)

Illuminance describes the amount of luminous flux falling on a surface. Relevant standards specify the required illuminance according to location and activity (EN 12464-1 "Lighting of indoor workplaces", EN 12464-2 "Lighting of outdoor workplaces", EN 12193 "Sports facility lighting")

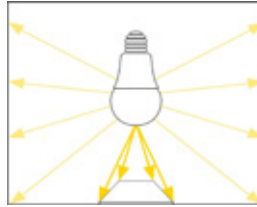

$$E = \Phi / A \quad lx = lm/m^2$$

E - illuminance
 Φ - luminous flux
A - area, m²
lx - lux

TYPICAL RECOMMENDED LEVELS OF MAINTAINED ILLUMINANCE

OPTIONS	Typical recommended level of maintained illuminance, lx	UGR	U _o	R _a
OFFICES				
Writing, typing, reading, data processing	500	19	0,6	80
Computer work stations	500	19	0,6	80
Technical drawing	750	16	0,7	80
Conference and meeting rooms	500	19	0,6	80
Reception desks	300	22	0,6	80
Filing, copying, etc.	300	19	0,4	80
Archives	200	25	0,4	80
CIRCULATION AREAS WITHIN BUILDINGS				
Circulation areas and corridors	100	28	0,4	40
Stairs, escalators, moving walkways	100	25	0,4	40
Elevators, lifts	100	25	0,4	40
Loading ramps/bays	150	25	0,4	40
REST, SANITATION AND FIRST AID ROOMS				
Canteens, pantries	200	22	0,4	80
Rest rooms	100	22	0,4	80
Rooms for physical exercise	300	22	0,4	80
Cloakrooms, washrooms, bathrooms, toilets	200	25	0,4	80
Sick bays	500	19	0,6	80
Rooms for medical attention	500	16	0,6	90
EDUCATIONAL BUILDINGS				
Classrooms, tutorial rooms	300	19	0,6	80
Classrooms for evening classes and adults education	500	19	0,6	80
Black, green wallboards and whiteboards	500	19	0,6	80
Entrance halls	200	22	0,4	80
Stairs	150	25	0,4	80
Circulation areas, corridors	100	25	0,4	80
Sports halls, gymnasiums, swimming pools (general use)	300	22	0,6	80
STORE ROOMS, FROZEN FOOD STORES				
Store and stockrooms	100	25	0,4	60
Dispatch packing handling areas	300	25	0,6	60

STORAGE RACK AREAS				
Gangways: unmanned	20	-	0,4	40
Gangways: manned	150	22	0,4	60
Control stations	150	22	0,6	80
Front of (high-bay) racks	200	-	0,4	60
FACTORY ASSEMBLY AREAS				
Rough work	300	25	0,6	80
Medium work	500	22	0,6	80
Fine work	750	19	0,7	80
VERY FINE WORK				
Instrument assembly	1000	19	0,7	80
Jewellery assembly/repairs	1500	16	0,7	90
Hospital autopsy tables and dissecting tables	5000	-	-	90
SPORTS FACILITIES				
Aerobics, athletics, dancing, gymnastics, swimming	500	-	-	60
Basketball, football, handball, table tennis, tennis, volleyball, weight lifting	750	-	-	60
School sports	750	-	-	60

UGR - Unified glare rating serves to define the psychological glare (visual discomfort) of lighting installations in indoor spaces

Uo - Uniformity is the ratio of minimum illuminance to average illuminance on a surface

Ra - Colour rendering index

LUMINOUS INTENSITY I (cd)

The luminous intensity describes the quantity of light emitted in a particular direction per unit solid angle. This is a useful measurement for directive lighting elements such as reflectors. It is represented by the luminous intensity distribution curve.

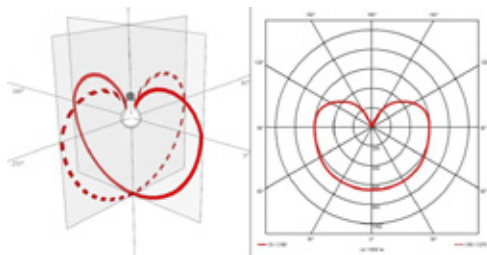

$$I = \Phi / \Omega \quad \text{cd} = \text{lm} / \text{sr}$$

I - luminous intensity

Φ - luminous flux, lm

Ω - solid angle into which luminous flux is emitted, sr

cd - Candela

sr - Steradian

LUMINANCE (cd/m²)

The intensity and brilliance of light emitted from an item in a given direction. Luminance is often used to characterize emission or reflection from flat, diffuse surfaces. The luminance indicates how much luminous power will be detected by an eye looking at the surface from a particular angle of view. Luminance is thus an indicator of how bright the surface will appear.

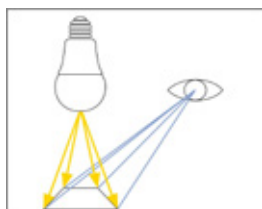

$$L = I / (A \cdot \cos \epsilon) \quad L = (E \cdot \rho) / \pi$$

where:

Ω - solid angle into which luminous flux is emitted, sr

A - area hit by luminous flux, m²

$A \cdot \cos \epsilon$ - visible area from direction ϵ

ρ - reflectance of area (for diffuse surface areas)

π - 3.14

BEAM ANGLE (DEGREE, °)

The Beam Angle is the angle between the two directions opposed to each other over the beam axis for which the luminous intensity is half that of the maximum luminous intensity.

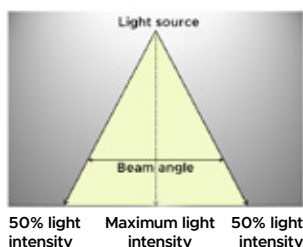

POWER CONSUMPTION (W)

The electrical power used by a luminaire or light source. Usually expressed in watt-hours (power consumed per hour).

ENERGY EFFICACY (lm/W)

The figure gained by dividing the total luminous flux by the power consumed. Used to express the luminous flux (amount of light) gained per watt, the higher the figure the more efficient is the luminaire.

LED LIFETIME (h)

The lifetime of a LED luminaire illustrates the target life expectancy (for example 50 000 hour life expectancy) which is a combination of light output degradation (L80 when the light output has reduced to 80% of its initial level) and source performance expectation (B10 when 10% of the LEDs lumen outputs falls below 80% of the nominal initial value) under specific conditions.

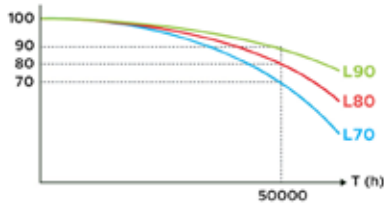

L - Lumen maintenance. L value tells that how many percent of luminous output is still left from the original.

B - Failure fraction. The value B10 means that minimum 90 % of the LED modules will meet the declared L-value and only 10% will have a lower flux level.

COLOUR TEMPERATURE (K)

Used to numerically express the colour of light sources, the redder the colour the lower the number and the bluer the colour the higher the number

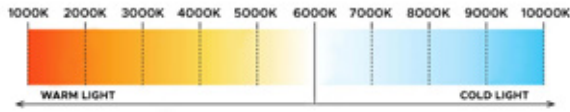

- 2700K - extra warm white
- 3000K - warm white
- 4000K - natural white
- 5000K - cool white
- 6500K - day light

K - Kelvin

COLOUR RENDERING INDEX (CRI)

Colour rendering describes how a light source makes the colour of an object appear to human eyes and how well subtle variations in colour shades are revealed. A colour rendering index is a quantitative measure of the ability of a light source to reveal the colours of various objects faithfully in comparison with an ideal or natural light source. The ability of the light source to render colours naturally, without distorting the hues seen under a black full spectrum radiator, like daylight or incandescent lamps. A minimum of 80 CRI is recommended for working areas.



Light sources are divided up into colour rendering levels:
CRI > 90 very good colour rendering
CRI > 80 good colour rendering

UNIFIED GLARE RATING (UGR)

UGR is a method of calculating glare from luminaires. The UGR value is calculated using a complex equation that includes the luminance value of the luminaire, the value of background luminance, the solid angle of the luminaire as seen by the viewer and several other values. Within an office setting, for the luminaire to be classified as "low glare" it must have a UGR below 19 at desk level. Anything above this may cause discomfort – this further enforces the need for high quality interior lighting that is rated UGR<19.

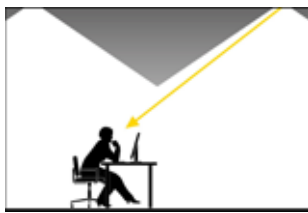

$$UGR = 8 \log \left[\frac{0.25}{L_b} \sum \left(\frac{L_v \omega_v}{P^2} \right) \right]$$

- UGR limits (UGRL) that must not be exceeded:
- ≤ 16 Technical drawing
 - ≤ 19 Reading, writing, training, meetings, computer-based work
 - ≤ 22 Craft and light industries
 - ≤ 25 Heavy industry
 - ≤ 28 Railway platforms, foyers

RECOGNITION DISTANCE (m)

Signs placed at all emergency exits along escape routes should be so illuminated as to indicate the direction to a place of safety in an unambiguous manner (EN1838 Lighting applications. Emergency lighting). Exit and direction signs should be clearly visible from anywhere along the escape route. All signs indicating emergency exits and escape routes should be in the same colour and format, whereas their minimum illuminance should be 2 cd/m².

As people in the building may not be familiar with its layout, internally illuminated, permanently powered safety signs are recommended. Note that internally illuminated safety signs are visible from a greater distance than the same size signs illuminated from the outside.

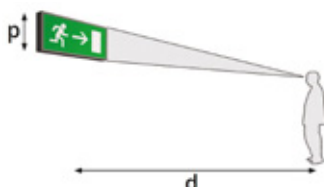

$$d = s \cdot p$$

- d** - viewing distance (maximum distance at which a sign is visible and recognizable), m
- p** - height of sign, m
- s** - constant value: 100 for externally illuminated signs and 200 for internally illuminated signs

DEGREES OF IP PROTECTION

IP is an acronym “Ingress Protection”. It is a measurement of the protection an item will have against solid objects (dust, sand, dirt, etc.) and liquids. An IP rating is comprised of 2 numbers. The first number refers to the protection against solid objects (dust, etc.) and the second number refers to protection against liquids.

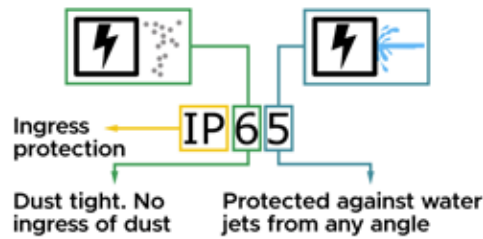

What is an IP Rating?















Each IP rating has two numbers, both of which give you information about the protection level. A higher number means greater protection against solids and liquids.

- The first number (0-6) refers to the level of protection against solid objects and moving parts, such as dust, debris, or other solid matter.
- The second number (0-8) references the level of liquid and moisture protection.

Take a look at the chart below to better understand the protection offered with each number.

IP rating chart

IP ratings are represented by combining the first and second digits of the following columns.

1 st DIGIT - SOLID	DEGREE OF PROTECTION AGAINST SOLID OBJECTS	2 nd DIGIT- WATER	DEGREE OF PROTECTION AGAINST WATER
0	No protection	0	No protection
1	 Protected against a solid object greater than 50mm, such as a hand	1	 Protected against water drops
2	 Protected against a solid object greater than 12.5mm, such as a finger	2	 Protected against water drops at a 15-degree angle
3	 Protected against a solid object greater than 2.5mm, such as a small tool	3	 Protected against water spray at a 60-degree angle
4	 Protected against a solid object greater than 1.0mm, such as a wire	4	 Protected against water splashing from any angle
5	 Dust protected. Prevents ingress of dust sufficient to cause harm	5	 Protected against water jets from any angle
6	 Dust tight. No ingress of dust	6	 Protected against powerful jets from and temporary flooding
		7	 Protected against the effects of temporary submersion in water (30 minutes at 0.15 to 1 meter)
		8	 Protected against the effects of permanent submersion in water (up to 3 meters). Depth specified by manufacturer

DEGREES OF IK PROTECTION

The IK rating is an international code which measures the degree of protection against mechanical wear and tear as well as the amount of impact a specific fixture can take. Essentially it is a measure of a fixtures robustness and durability.

So why is a fixtures IK rating important and when do they become relevant when choosing a fixture?









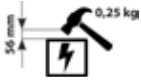

If you are choosing a fixture which will be fitted within a high traffic area such as street, highway or other commercial environments, then it's important to choose a fixture with an appropriate IK rating.

If a fixture was to become damaged, it could result in the fixture failing to work efficiently, or worse still, failing completely.

You don't need a fixture which is highly resistant if there is little or no risk of impact. So, analyzing your risk of impact is the first step in deciding if you need a fixture with a high IK rating. It's not just high traffic areas which need IK rated fixtures, but if the area is prone to vandalism it's a good idea too. For areas of low risk an IK rating of IK07 and below is ideal. IK08 is great for areas which provide a reasonable risk of impact, whereas for maximum protection in places such as parks, schools, prisons and subways IK10 is essential.

IK rating chart

The degree of mechanical protection is identified by a code that consists of the letters IK followed by two digits:

IK NUMBER	ENERGY		EQUIVALENT IMPACT
00	No protection		No protection
01	Protected against 0.14 joules impact		Equivalent to impact of 0.25 kg mass dropped from 56 mm above impacted surface
02	Protected against 0.2 joules impact		Equivalent to impact of 0.25 kg mass dropped from 80 mm above impacted surface
03	Protected against 0.35 joules impact		Equivalent to impact of 0.25 kg mass dropped from 140 mm above impacted surface
04	Protected against 0.5 joules impact		Equivalent to impact of 0.25 kg mass dropped from 200 mm above impacted surface
05	Protected against 0.7 joules impact		Equivalent to impact of 0.25 kg mass dropped from 280 mm above impacted surface
06	Protected against 1 joules impact		Equivalent to impact of 0.25 kg mass dropped from 400 mm above impacted surface
07	Protected against 2 joules impact		Equivalent to impact of 0.5 kg mass dropped from 400 mm above impacted surface
08	Protected against 5 joules impact		Equivalent to impact of 1.7 kg mass dropped from 300 mm above impacted surface
09	Protected against 10 joules impact		Equivalent to impact of 5 kg mass dropped from 200 mm above impacted surface
10	Protected against 20 joules impact		Equivalent to impact of 5 kg mass dropped from 400 mm above impacted surface

DESCRIPTION OF OPTIONS



OPTIONS

LED:

T730	Colour temperature 3000K, CRI 70+
T740	Colour temperature 4000K, CRI 70+
T750	Colour temperature 5000K, CRI 70+
T757	Colour temperature 5700K, CRI 70+
T765	Colour temperature 6500K, CRI 70+
T830	Colour temperature 3000K, CRI 80+
T840	Colour temperature 4000K, CRI 80+
T830/40	Colour temperature 3000/4000K, CRI 80+
T850	Colour temperature 5000K, CRI 80+
T857	Colour temperature 5700K, CRI 80+
T865	Colour temperature 6500K, CRI 80+
T930	Colour temperature 3000K, CRI 90+
T940	Colour temperature 4000K, CRI 90+
T820 MEAT	Special spectrum for meat 2000K "pink", CRI 80+
T831 MEAT&WHITE	Special spectrum for meat products with increased white colour contrast 3100K, CRI 80+
T825 BREAD	Special spectrum for bread 2500K, CRI 80+
T930 VEGETABLES	Special spectrum for colourful products. Fruits, fashion 3000K, CRI 90+
T932 FASHION	Special spectrum for fashion 3200K, CRI 90+
T931 FASHION&WHITE	Special spectrum for fashion with dominant white colour 3100K, CRI 90+
NATURAL	Special spectrum, closely matching natural sunlight
T927 NATURAL	Colour temperature 2700K, CRI 90+ NATURAL
T930 NATURAL	Colour temperature 3000K, CRI 90+ NATURAL
T940 NATURAL	Colour temperature 4000K, CRI 90+ NATURAL

MATERIAL:

SS304	Stainless-steel ring, grade 304
ALU	Luminaire body made from aluminium sheet
ABS/PMMA	ABS/PMMA - body made from acrylonitrile butadiene styrene and diffuser from acrylic
ABS/PC	ABS/PC - body made from acrylonitrile butadiene styrene and diffuser from polycarbonate plastic
PC/PC	PC/PC - body and diffuser made from polycarbonate plastic
PC	Opal PC diffuser for IK10 impact resistance

REFLECTOR AND OPTICS:

OP	Opal diffuser with high light transmittance
OP LT80	Opal diffuser with high light transmittance
DPRZ LT80	De-glaring micro-prismatic diffuser, matt
MPRZ LT92	Translucent micro-prismatic diffuser with high light transmittance
DPRZ	De-glaring micro-prismatic diffuser
MPRZ	Opal micro-linear prismatic diffuser
FROST	Translucent "frost" structure diffuser with high light transmittance
CLR	CLR - clear glass diffuser
2CLR	Double optics system with additional illumination of the surface under the luminaire
GLASS	GLASS - tempered glass diffuser
OP TP(a)	TP(a) rated thermoplastic opal diffuser
L2	Optics with 2° beam angle
L6	Optics with 6° beam angle
L8	Optics with 8° beam angle
L10	Optics with 10° beam angle
L10X60	Optics with 10x60° beam angle
L10X70	Optics with 10x70° beam angle
L12	Optics with 12° beam angle
L15	Optics with 15° beam angle

L15X30	Optics with 15x30° beam angle
L15X38	Optics with 15x38° beam angle
L15X65	Optics with 15x65° beam angle
L30	Optics with 30° beam angle
L30X65	Optics with 30x65° beam angle
L30X70	Optics with 30x70° beam angle
L36	Optics with 36° beam angle
L40	Optics with 40° beam angle
L45	Optics with 45° beam angle
L40X75	Optics with 45x75° beam angle
L50	Optics with 50° beam angle
L60	Optics with 60° beam angle
L75	Optics with 75° beam angle
L75W	Optics with 75° beam angle, wide
L90	Optics with 90° beam angle
L90X90	Optics with 90x90° beam angle
L90W	Optics with 90° beam angle, wide
L100	Optics with 100° beam angle, diffused
L120	Optics with 120° beam angle
L120X105	Optics with 120x105° beam angle
LS20	Optics with 20x20° beam angle
LS30	Optics with 30x30° beam angle
LS45	Optics with 45x45° beam angle
LS60	Optics with 60x60° beam angle
LS90	Optics with 90x90° beam angle
LS140	Optics with 140x140° beam angle, wide area lighting such as parking lots
LSA1	Optics with asymmetric beam SA1, area lighting with shorter illumination distances
LSA2	Optics with asymmetric beam SA2, narrow forward throw beam for area lighting
LSM1	Optics with asymmetric beam SM1, universal road lighting
LSM2	Optics with asymmetric beam SM2, fulfilling EN13201 M class requirements where road width is similar to pole height
LSS1	Optics with asymmetric beam SS1, fulfilling EN13201 M class requirements where road width is equal or less the pole height
LSS2	Optics with asymmetric beam SS2, fulfilling EN13201 M class requirements for wider roads
LSPR	Fully asymmetric beam designed to highlight pedestrian crossings for right side traffic
LSPL	Fully asymmetric beam designed to highlight pedestrian crossings for left side traffic
LS1A18	Optics with asymmetric beam
L1A50	Optics with asymmetric beam
LS1A18-L	Optics with asymmetric beam, light direction - left
LS1A18-R	Optics with asymmetric beam, light direction - right
L1A18	Optics with asymmetric beam
L2A25	Optics with double asymmetric beam, retail
R15	Reflector with 15° light beam angle
R24	Reflector with 24° light beam angle
R32	Reflector with 32° light beam angle
R36	Reflector with 36° light beam angle
R40	Reflector with 40° light beam angle
R45	Reflector with 45° light beam angle
R55	Reflector with 55° light beam angle
R60	Reflector with 60° light beam angle
WGC	White gloss reflector with clear lens
BGC	Black gloss reflector with clear lens
WMC	White matt reflector with clear lens
BMC	Black matt reflector with clear lens
MGC	Metallic mirror finish reflector with clear lens
MMC	Metallic matt reflector with clear lens

WAC	Metallic mirror finish asymmetrical reflector with white shade and clear lens
BAC	Metallic mirror finish asymmetrical reflector with black shade and clear lens
LIGHT OUTPUT LEVELS:	
LO1...6	Light output level 1 to 6
COVERS:	
LOUVER	Decorative louver
LG3	Luminaire fits to LG3 requirements (with direct/indirect light distribution)
SHADE	Deglarng decorative shade for Sargas LED luminaire
SPORT	Luminaire equipped with white painted protection grid suitable for sport halls
CONTROL GEAR:	
DALI	Driver with DALI interface and switch-control dimming
DALI LOOP	Driver with DALI interface, switch-control dimming and doubled input terminals for looping the mains cables
DALIsep	Driver with DALI interface and with possibility to control down and up light separately
ROTARY DIM	Integrated rotary switch device and driver with 0-10V control dimming
CLO	Driver with Constant Light Output functionality
TDIM	Driver with trailing-edge and leading-edge dimming
ADIM	Driver with autonomous two-level dimming
EAIRB	Integrated smart sensor and driver with Bluetooth® communication and grouping possibilities for lighting control
EAIRB-M	Master luminaire with integrated smart sensor and driver with Bluetooth® communication and grouping possibilities for lighting control
EAIRB-S	Slave luminaire with integrated EAIR type driver for lighting control
HBEAIRB-M	Master luminaire with integrated smart sensor for high ceiling (up to 16m) and driver with wireless communication and grouping possibilities for lighting control
HBEAIRB-S	Slave luminaire with integrated EAIR type driver for lighting control
BLT	Integrated wireless control unit and driver for lighting control via mobile device (via Bluetooth®)
TW	Integrated light source and driver for Tuneable white control 2700-6500 K
BLT TW	Integrated light source, wireless control unit and driver for Tuneable white control 2700-6500 K via mobile device (via Bluetooth®)
KRBLT	Integrated wireless control unit for KRBLT bluetooth mesh system integration, ON/OFF
KRBLT DALI	Integrated wireless control unit for KRBLT bluetooth mesh system integration, DALI
COR	Driver with Corridor function (never off)
COR1MIN	Driver with Corridor function 1min (switch off after 1 min.)
COR30MIN	Driver with Corridor function 30min (switch off after 30 min.)
PULL	Pull switch device, on/off
ASW	Integrated anti-vandal switch
PULLDIM	Pull switch device and driver with switch-control dimming
DALI ZHAGA18	Driver with D4i interface and integrated ZHAGA18 socket. W/O sensor, up
DALI ZHAGA18 DOWN	Driver with D4i interface and integrated ZHAGA 18 socket. W/O sensor, down
DALI 2XZHAGA18	Driver with D4i interface and integrated two ZHAGA 18 sockets. W/O sensor, up&down
DALI NEMA5p	Driver with DALI interface and integrated NEMA 5 pin socket. W/O sensor
DALI 2WIE5D	Driver with DALI interface and switch-control dimming. Two 5-pole DALI "Wieland - gesis classic" type or compatible connectors. Through wired, 3x1.5mm ² + 2x0.5mm ² (DALI)
Lsep	Option that enables to control (on/off) Down and up lights separately
T	Tridonic LED driver - (only by customer's request)
SENSORS:	
PCA	Photocell 20mm miniature type, IP65, 35 lux; 1:05 ratio
MWRFS	Integrated microwave (MW) motion sensor with integrated RF (radio wave) receiver. Sensor can serve as slave. Functions: Staircase, Corridor, (no dimming control).
MWRFMD	Built-in microwave motion sensor with integrated wireless transceiver. Sensor can serve as both master and slave. Functions: Staircase, Corridor, dimming control
MWRFM	Built-in microwave motion sensor with integrated wireless transceiver. Sensor can serve as both master and slave. Functions: Staircase, Corridor
MWRFS D	Built-in wireless receiver for receiving master luminaire control signals. Functions: Staircase, Corridor, dimming control
MWRFS	Built-in wireless receiver for receiving master luminaire control signals. Functions: Staircase, Corridor

PIR	Integrated PIR sensor with on-off control
HBPIR-M	Master luminaire with Integrated PIR sensor for high ceiling (up to 12 meters) with on-off control, possibility to connect and control other (slave) luminaires (parameters according to datasheet)
HBPIR7m-M	Master luminaire with Integrated PIR and LUX level sensing sensor for high ceiling (up to 7 meters) with on-off control, possibility to connect and control other (slave) luminaires (parameters according to datasheet)
HBPIR15m-M	Master luminaire with Integrated PIR and LUX level sensing sensor for high ceiling (up to 15 meters) with on-off control, possibility to connect and control other (slave) luminaires (parameters according to datasheet)
DALI HBPIRD15m-M	DALI master luminaire with Integrated driver and sensor for high ceilings (up to 15 meters), with possibility to control DALI (slave) luminaires (parameters according to datasheet)
KRBLT HBPIR15m-M	Master luminaire with smart batten-fit PIR sensor for high ceilings (up to 15 meters), bluetooth controllable, with wireless communication and grouping possibility of slave luminaires.
DALI KRBLT HBPIRD15m-M	Master luminaire with smart batten-fit PIR DALI sensor for high ceilings (up to 15 meters), bluetooth controllable, with wireless communication and grouping possibility of slave luminaires.

EMERGENCY:

EMGB	Emergency version 1 hour (best available technology)
EM3	Emergency version 3 hours
EM3B	Emergency version 3 hours (best available technology)
EM3A	Emergency version equipped with an autonomous testing system, 3 hours
EM3Atmin-25	Emergency version equipped with an autonomous testing system, 3 hours. Suitable for low ambient temperatures up to -25°C
EM3D	Emergency version 3 hours with DALI interface
EM3LER	Emergency version 3 hours, lens - escape route
EM3LOA	Emergency version 3 hours, lens - open areas
LER	Optic for escape route
LOA	Optic for open areas
LEW	Lens for escape route (wide corridor)
LOU	Optic for mixed areas/universal
LOS	Lens with asymmetric beam
TEST	Manual test button
AUT	Autonomous testing system
CEB	Fitting to central battery system
CLV	Fitting to low voltage central 24V battery system CEBLV
CLV2	Fitting to low voltage central 48V battery system CEBLV
EMS	Fitting to emergency monitoring system
2CLR	Double optics system with additional illumination of the surface under the luminaire
DALI EM3D 2WIE5D	Driver with DALI interface. Two 5-pole DALI "Wieland - gesis classic" type or compatible connectors. Through wired, 3x1.5mm ² + 2x0.5mm ² (DALI). Emergency version 3 hours

CONNECTION:

5TB	5-pole terminal block in middle of luminaire for easy through wiring
1LIN	Through wiring single phase d=1.5 mm ² with two push-in terminal blocks
2LIN	Through wiring two phases d=1.5 mm ² with two push-in terminal blocks
3LIN	Through wiring three phases d=1.5 mm ² with two push-in terminal blocks
1LIN2.5	Through wiring single phase d=2.5 mm ² with two push-in terminal blocks
2LIN2.5	Through wiring two phases d=2.5 mm ² with two push-in terminal blocks
3LIN2.5	Through wiring three phases d=2.5 mm ² with two push-in terminal blocks
1LINS	Through wired 3x1.5 mm ² with female and male sockets (5x1.5 mm ² DALI)
3LINS	Through wired 5x1.5 mm ² with female and male sockets
1ENDS	Individually installed/last luminaire in line 3x1,5 mm ² with socket (5x1,5 mm ² DALI)
3ENDS	Individually installed/last luminaire in line 5x1,5 mm ² with socket
C3	2x 3-poles quick connection cable glands for Ø7-11mm cable, Push-in terminal, 3x2.5mm ²
C5	Additional 5 poles connector
L-BRANCH	Through wired 5x1.5 mm ² with branch to the left
R-BRANCH	Through wired 5x1.5 mm ² with branch to the right
L1	Driver connected to L1 line
L2	Driver connected to L2 line
L3	Driver connected to L3 line

1G	Strain relief for power supply cable
2G	Strain relief for power supply cable, 2pcs
WIE3	3-pole "Wieland - gesis classic" type or compatible connector
WIE5	5-pole "Wieland - gesis classic" type or compatible connector
WIE5D	5-pole DALI "Wieland - gesis classic" type or compatible connector
WIE3-0.5m	3-pole "Wieland - gesis classic" type or compatible connector with 0.5m cable
WIE3-1.5m	3-pole "Wieland - gesis classic" type or compatible connector with 1.5m cable
WIE3-3.0m	3-pole "Wieland - gesis classic" type or compatible connector with 3.0m cable
WIE4-0.5m	4-pole "Wieland - gesis classic" type or compatible connector with 0.5m cable
WIE4-1.5m	4-pole "Wieland - gesis classic" type or compatible connector with 1.5m cable
WIE4-3.0m	4-pole "Wieland - gesis classic" type or compatible connector with 3.0m cable
WIE5-0.5m	5-pole "Wieland - gesis classic" type or compatible connector with 0.5m cable
WIE5-1.5m	5-pole "Wieland - gesis classic" type or compatible connector with 1.5m cable
WIE5-3.0m	5-pole "Wieland - gesis classic" type or compatible connector with 3.0m cable
WIE5D-0.5m	5-pole DALI "Wieland - gesis classic" type or compatible connector with 0.5m cable
WIE5D-1.5m	5-pole DALI "Wieland - gesis classic" type or compatible connector with 1.5m cable
WIE5D-3.0m	5-pole DALI "Wieland - gesis classic" type or compatible connector with 3.0m cable
2WIE3	Two 3-pole "Wieland - gesis classic" type or compatible connectors. Through wired, 3x1.5mm ²
2WIE5	Two 5-pole "Wieland - gesis classic" type or compatible connectors. Through wired, 5x1.5mm ²
2WIE5D	Two 5-pole DALI "Wieland - gesis classic" type or compatible connectors. Through wired, 3x1.5mm ² + 2x0.5mm ² (DALI)
QBX3-0.1m	3-pole quick connection box on 0.1m cable, Push-in terminal, 3x2x2.5mm ²
CBF3X1.5-N m	Outgoing flexible cable 3x1.5mm ² , length according to customer specification
CBF5X1.5-N m	Outgoing flexible cable 5x1.5mm ² , length according to customer specification
CBF3-1.5m	Outgoing flexible cable 3x0.75mm ² 1.5m
CBF3-3.0m	Outgoing flexible cable 3x0.75mm ² 3.0m
CBF3-2.0m clear	Cable 3x0.75mm ² for suspended luminaire up to 2.0 meters, transparent
CBF3-3.0m clear	Cable 3x0.75mm ² for suspended luminaire up to 3.0 meters, transparent
CBF5-2.0m clear	Cable 5x0.75mm ² for suspended luminaire up to 2.0 meters, transparent
CBF5-3.0m clear	Cable 5x0.75mm ² for suspended luminaire up to 3.0 meters, transparent
1LIN 2xCBF3x0.3m	Through wiring single phase d=1.5 mm ² with two flexible cables 3x1.5mm ² . Cable lengths: 0.3m
Schuko-1.5m	3-pole "Schuko" type plug with 3x1.0mm ² 1.5m cable
Schuko-3.0m	3-pole "Schuko" type plug with 3x1.0mm ² 3.0m cable
Europlug-1.5m	2-pole "Europlug" type plug with 2x1.0mm ² 1.5m cable
Europlug-3.0m	2-pole "Europlug" type plug with 2x1.0mm ² 3.0m cable
1LIN I-join L	Luminaire designed to in-line connection with join element - end/first luminaire (joint element not included). Through wired 3x1.5 mm ² with two push-in terminal blocks
1LIN I-join LL	Luminaire designed to in-line connection with join element - intermediate luminaire (joint element not included). Through wired 3x1.5 mm ² with two push-in terminal blocks
TRACK	Luminaire version with track adaptor designed to be fixed into 4/6-conductors surface/recessed tracks. Track adaptor (3-phase + N) with phase selector
LOOP	LED driver with doubled input terminals for looping the mains cables
CONCB/4	Longer connecting cable for installing luminaires into every fourth ceiling tile
SOCS44	Built-in schuko socket outlet with hinged cover (IP44)
2X LCS 75/5	Two 5-pole LCS 75/5 connectors for easy installation. Through wired, 5x1.5mm ²
OTHER:	
L	for in-line connection end/first luminaire (lengths: ...mm)
LL	for in-line connection intermediate luminaire (lengths: ...mm)
I-join L	Luminaire designed to in-line connection with join element - end/first luminaire (joint element not included)
I-join LL	Luminaire designed to in-line connection with join element - intermediate luminaire (joint element not included)
L I-JOIN LL	Luminaire designed for in-line connection with join element and intermediate luminaire (joint element not included)
IC	Stainless steel clips
CL	CL - body with aluminum clips
W625	Designed for the German market to fit 625x625 suspended ceiling
W45	Luminaire with narrow body. Width: 45mm

CORNER90	Luminaire designed to connect lighting lines in 90° angle
CORNER180	Luminaire designed to connect lighting lines in "T" shape
CORNER360	Luminaire designed to connect lighting lines in "X" shape
UP	With up light source only
DOWN	With down light source only
SR	Luminaire for surface mounting
SUS	Suspended version
SUSI	Suspended version and suspension wire set "I" type, 1.5m adjustable
SUSY	Suspended version and suspension wire set "Y" type, 1.5m adjustable
SB	Support brackets for installation into a plasterboard ceiling
HSB	Adjustable hanger support brackets for luminaire installation across cable trays. Each end extends 180-600mm
2Gr	Pre-drilled end caps with extra sealing grommets included
INSERT	Fully covered internal part of the luminaire
HOL	Holder for wall-mounted version
GRO	Ground spike for ground-mounted version
RND BLACK	Round luminaire frame in black
SQ WHITE	Square luminaire frame in white
SQ BLACK	Square luminaire frame in black
GLASS WHITE	Round luminaire frame in white, with dropped down glass cover
GLASS BLACK	Round luminaire frame in black, with dropped down glass cover
DROP T24	Luminaire version for drop tile style suspended ceilings (600 T24)
DROP T15	Luminaire version for drop tile style suspended ceilings (600 T15)
Direct	Only with direct down light

PROTECTION:

Ex	For areas with a danger of flammable dust or gas explosion
tmin-25	Suitable for low temperatures with ta -25..+40°C
ta-40+50C	Luminaire suitable for extreme ambient conditions Ta -40..+50°C
Tmin-40C	Luminaire suitable for low ambient temperatures up to -40°C
10KV	Additional Surge Protection device - 10KV
IP20	IP20 protection degree
IP23	IP23 protection degree
IP40	IP40 protection degree
IP44	IP44 protection degree
IP54	IP54 protection degree
IP65	IP65 protection degree
IP66	IP66 protection degree
IP67	IP67 protection degree
IP68	IP68 protection degree
I	Electric shock protection class I
II	Electric shock protection class II
III	Electric shock protection class III
ETC	External temperature control for protecting LED modules against overheating

COLOUR:

DGREY	Dark grey thermoplastic body
RAL	RAL colour
WHITE	White thermoplastic body
LGREY	Light grey thermoplastic body
BLACK	Black thermoplastic body
M... (felt colour code)	Felt colour
T... (fabric colour code)	Fabric colour

NOTES

A series of horizontal dotted lines for writing notes.

CONTACTS



Europe, Middle East, Africa,
Australia, USA

Tel: +370 37 746618

info@northcliffe.org



United Kingdom

Tel: +44 7827 997585

uk@northcliffe.org



For countries not listed,
please contact:

info@northcliffe.org

DISCLAIMER: All the information given in this catalog is the result of our research work experience. It is given in good faith and with every belief in its accuracy but cannot be considered as a formal warranty. In accordance with NORTHCLIFFE LIGHTING policy of product development this information is subject to change without notice.

Photos are for illustrational purposes only. The exact appearance of the product may vary depending on the options selected and other factors.

Date of issue: 13.03.2024



NORTHCLIFFE

making life brighter

Northcliffe Lighting, UAB
Raudondvario str. 101
LT-47184 Kaunas, Lithuania

Tel.: +370 37 746618
info@northcliffe.org

www.northcliffe.org

